

# SOMMAIRE

## 01 Verrerie 3 – 83



Chef & Sommelier .....	4 à 11
OGO .....	12 à 13
Zwiesel .....	14 à 17
Luigi Bormioli .....	18 à 23
RCR .....	24 à 27
Arcoroc .....	28 à 35
Bormioli Rocco .....	36 à 39
Pasabahce .....	40 à 47
Novastyl .....	48 à 51
Onis .....	52 à 53
Barware .....	54 à 60
Gobelets chopos .....	61 à 72
Bouteilles Carafe .....	73 à 78
Photothèque verrerie .....	79 à 81
Personnalisation sur verre .....	82 à 83

## 02 Vaisselle 84 – 173



Personnalisation vaisselle .....	84 à 85
OGO .....	88 à 103
ID Fine .....	104 à 111
Bonna .....	112 à 121
Novastyl .....	122 à 135
Porcelaine blanche .....	136 à 143
Pastas & Salades et Spécialités .....	144 à 146
Sarreguemines .....	147
Opal .....	148 à 151
Vaisselle verre et Saladiers .....	152 à 154
Plats individuels .....	155
Ramequins et bols .....	156 à 157
Coupes à dessert .....	158 à 159
Mise en bouche .....	160 à 161
Service à thé et café .....	162 à 167
Tasses blanches et colorés .....	168 à 169
Photothèque vaisselle .....	170 à 173

## 03 Cuisson 174 – 219



Acier Inoxydable .....	176 à 185
Aluminium .....	186 à 191
Fonte émaillée .....	194
Tajines et Couscous .....	195 à 196
Émail .....	197
Cuisson au four - Grès .....	198
Cuisson au four - Acier carbone .....	199 à 201
Bacs gastronomiques .....	202 à 203
Cuisson au four - Verre .....	204 à 208
Storage .....	209 à 215
Matériel électrique .....	216 à 219

## 04 Couverts 220 – 237

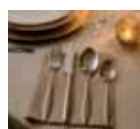

Couverts séries .....	222 à 233
Couteaux à steak .....	234 à 235
Cuillères .....	236
Fruits de mer .....	237

## 05 Accessoires et cuisine 238 – 267



Moulins à sel et poivre .....	239 à 241
Condiments et accessoires .....	242 à 243
Accessoires de cuisine .....	244 à 249
Plateaux et services .....	250 à 251
Accessoires du bar .....	252 à 257
Sets de table .....	258 à 259
Couteaux professionnels .....	260 à 261
Ustensiles de cuisine .....	262 à 263
Pâtisserie .....	264
Pesage .....	265
Ménage .....	266 à 267

## 06 Mobilier 268 – 279



Fauteuils de table extérieurs .....	270
Mobilier extérieur .....	271 à 273
Fauteuils de table extérieurs .....	274 à 276
Fauteuils Lounge .....	277 à 279

## 07 Index alphabétique 280 à 283

Index numérique .....	284 à 288
-----------------------	-----------





ARCOROC

bonna



COUZON



ID Fine

tehrun

LEIFHEIT

Le Parfait

LUBIANA



Luminarc



novastyl

Now'S HOME



OGO

Paşabahçe  
LIVE BEAUTIFUL

PYREX

onís



SABATIER  
DEPUIS 1812 - THIERS

Sarreguemines  
France 1764

SOEHNLE

Tefal



# 01

## VERRERIE



• Chef & Sommelier	4 à 11
OGO	12 à 13
Zwiesel	14 à 17
Luigi Bormioli	18 à 23
RCR	24 à 27
Arcoroc	28 à 35
Bormioli Rocco	36 à 39
Pasabahce	40 à 47
Novastyl	48 à 51
Onis	52 à 53
Barware	54 à 60
Gobelets Chopes	61 à 72
Bouteilles Carafe	73 à 78
Photothèque verrerie	79 à 81
• Personnalisation sur verre	82 à 83

Chef&Sommelier

MADE IN FRANCE



## Le Cristallin extra-fin

Aujourd'hui, Chef&Sommelier™ ouvre un nouveau chapitre avec une évolution majeure de son matériau signature : le Krysta.

Ce cristallin, déjà reconnu pour sa résistance et sa brillance exceptionnelles, atteint désormais une finesse inégalée. Grâce à un procédé de fabrication de pointe, le Krysta EXTRA-FIN permet de créer des verres aux parois, bords et jambes d'une finesse et d'un raffinement incomparables. Cette prouesse technique n'a qu'un seul objectif : sublimer l'expérience de dégustation et amplifier chaque nuance du vin grâce à la sensation délicate du verre.



Bord fin 0,7 mm



Jambe fine 4,5 mm

Pied large 86 mm

## Galea

Ce verre, aux courbes généreuses et à la finesse subtile, magnifie les cocktails créés par les mixologues. Avec sa silhouette, fluide et aérienne, plus qu'un simple contenant, c'est une œuvre d'art qui rend hommage à une époque où beauté et fonction étaient intimement liées. Éclat et raffinement.



A.



B.

Code	Ccl	Φ x Ht cm	Sur.	Prix HT
A . 75 11 365	65	10,5 x 25	12	6,89
B . 75 11 364	55	9,3 x 24,4	12	6,37



C.



D.

Code	Ccl	Φ x Ht cm	Sur.	Prix HT
C . 75 11 363	47	8,9 x 23,5	12	6,37
D . 75 11 362	38	8,5 x 21,9	12	6,05

New products  
Nouveautés

## Mylla

La gamme Mylla séduit par son design raffiné et ses courbes parfaitement équilibrées. Chaque verre capte la lumière, mettant en valeur la présentation et transformant chaque dégustation en une expérience visuelle et sensorielle unique : Chambre aromatique large. Angle doux très élégant.



C&S  
Chef & Sommelier



A.



B.



C.



D.

Code	Ccl	Φ x Ht cm	Sur.	Prix HT
A . 75 11 356	65	10,5 x 25	12	6,89
B . 75 11 355	55	9,4 x 24,3	12	6,37

Code	Ccl	Φ x Ht cm	Sur.	Prix HT
C . 75 11 354	47	8,9 x 23	12	6,37
D . 75 11 353	38	7,5 x 21,6	12	6,05



C&S  
Chef & Sommelier  
FRANCE

## Verres à pied

## Open up

Une ligne de verres au design contemporain et révolutionnaire, qui procure un plaisir olfactif sans commune mesure. Elle permet de déguster tous les types de vins jeunes (de 1 à 3 ans pour les blancs et de 1 à 5 pour les rouges). Les différents modèles de la ligne Open Up couvrent la majorité des cépages mondiaux.



A . Tannic



B . Universal



C . Soft



D . Round

Code	Ccl	Φ x Ht cm	Sur.	Prix HT
A . 75 10 941	55	10,7 x 23,3	24	6,64
B . 75 10 929	40	9,1 x 23,1	24	6,29

Code	Ccl	Φ x Ht cm	Sur.	Prix HT
C . 75 10 938	47	10,3 x 22,8	24	6,29
D . 75 10 920	37	9,6 x 21,1	24	6,29



E . Pro tasting



Code	Ccl	Φ x Ht cm	Sur.	Prix HT
E . 75 10 932	32	8,7 x 18	24	5,39



F . Flûte

Code	Ccl	Φ x Ht cm	Sur.	Prix HT
F . 75 10 926	20	7,4 x 23,4	24	6,29

## Open Up

Design contemporain et révolutionnaire.



G . FH



H . Warm



I . FB

Code	Ccl	Φ x Ht cm	Sur.	Prix HT
G . 75 06 422	35	7,7 x 11,8	24	3,27
H . 75 06 423	29	9,9 x 8,6	24	5,97

Code	Ccl	Φ x Ht cm	Sur.	Prix HT
I . 75 06 420	38	9,3 x 9,4	24	3,27





## Symétrie

Les lignes optiques sur les paraisons des verres offrent un spectacle visuel et les reliefs favorisent l'oxygénation pour un plaisir gustatif garanti.



A.



B.



C.

Code	Ccl	Φ x Ht cm	Sur.	Prix HT
A . 75 11 292	55	9,2 x 26	24	5,09
B . 75 11 291	45	8,7 x 25	24	4,66

Code	Ccl	Φ x Ht cm	Sur.	Prix HT
C . 75 11 290	35	7,8 x 23	24	4,66



D.



E.



F. Flûte



G. Flûte

Code	Ccl	Φ x Ht cm	Sur.	Prix HT
D . 75 11 293	58	10,6 x 20,9	24	5,09
E . 75 11 294	21	11,4 x 18	24	5,54

Code	Ccl	Φ x Ht cm	Sur.	Prix HT
F . 75 11 296	21	6,5 x 24	24	4,88
G . 75 11 295	16	6,5 x 19,8	24	4,23

## Sublym

Un verre universel tous cépages. Légèreté dans le mouvement et la forme. Une paraison haute et rétrécie pour accentuer l'élégance du verre et pour une meilleure dégustation. Belle transition entre la paraison et la jambe.



H.



I.



J.



K. Flûte

Code	Ccl	Φ x Ht cm	Sur.	Prix HT
H. 75 10 910	55	9,2 x 26	12	4,62
I . 75 10 911	45	8,7 x 25	12	4,23
I . 75 10 912	35	8 x 23	24	4,23

Code	Ccl	Φ x Ht cm	Sur.	Prix HT
J . 75 10 913	25	7,2 x 20,7	24	4,00
K . 75 10 914	21	7 x 24	24	4,42



Verres à pied

### Exaltation

Forme consensuelle avec look premium. Jambe étirée et fond piqué.



A .



B .



C . Flûte

Code	Ccl	Φ x Ht cm	Sur.	Prix HT
A . 75 11 338	70	9,6 x 24	12	6,20
A . 75 11 337	55	9,6 x 24	12	4,59
B . 75 11 335	38	8,6 x 21,5	12	4,23

Code	Ccl	Φ x Ht cm	Sur.	Prix HT
B . 75 11 336	47	9,1 x 22,7	12	4,23
C . 75 10 825	30	7,8 x 21,1	24	4,23
C . 75 10 826	35	8,1 x 23,5	24	4,59



### Distinction

Distinguée par ses lignes anguleuses, la collection de verres à pied Distinction scénarise avec brio le plaisir de la dégustation des vins jeunes.



D .



E .



F .



G .

Code	Ccl	Φ x Ht cm	Sur.	Prix HT
D . 75 11 282	47	9,6 x 23,3	24	4,23
E . 75 11 281	38	9,1 x 22	24	4,23

Code	Ccl	Φ x Ht cm	Sur.	Prix HT
F . 75 11 280	28	8,3 x 20,7	24	4,00
G . 75 11 283	23	7 x 23,3	24	4,01

### Vigne

Coupé à froid, buvant fin.



H . FH



I . FH



J . FH



K . FH



L . FB



M . FB

Code	Ccl	Φ x Ht cm	Sur.	Prix HT
H . 75 06 150	45	7 x 16,5	24	2,82
I . 75 06 153	33	6,9 x 12,6	24	2,62

Code	Ccl	Φ x Ht cm	Sur.	Prix HT
J . 75 06 148	22	6,1 x 11,1	24	2,44
K . 75 06 146	6	4,2 x 9	48	1,31

Code	Ccl	Φ x Ht cm	Sur.	Prix HT
L . 75 06 152	31	8,4 x 8,3	24	2,60
M . 75 06 151	20	7,5 x 7,4	24	2,28



## Séquence

La série Séquence est remarquable d'équilibre. Sa paraison de forme tulipe classique trouve sa modernité dans le design à la fois généreux, fin et élancé. Sa jambe bien proportionnée, tout en élégance et pas trop haute est pratique pour les restaurants, les bars à vin et le banqueting.

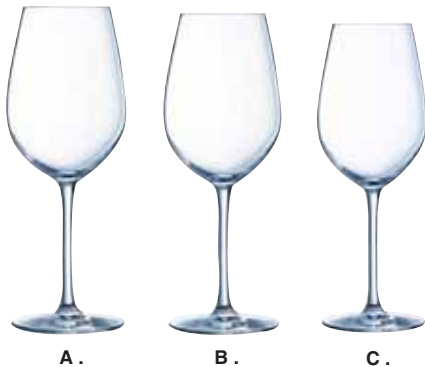

A.

B.

C.

Code	Ccl	Φ x Ht cm	Sur.	Prix HT
A . 75 10 868	53	9 x 23,5	12	4,62
B . 75 10 867	44	8,7 x 22,7	12	4,23
C . 75 10 866	35	7,9 x 21	24	4,23



D . Flûte impérial 24cl



E . Flûte

Code	Ccl	Φ x Ht cm	Sur.	Prix HT
D . 75 11 188	24	7 x 23,5	24	4,00
E . 75 10 865	17	5,6 x 20,8	24	4,00



## Evidence

Design équilibré grâce à sa jambe courte pour une efficacité évidente.



F.

G.

H . Flûte

Code	Ccl	Φ x Ht cm	Sur.	Prix HT
F . 75 11 316	35	7,9 x 19	24	3,65
G . 75 11 315	27	7,4 x 18	24	3,44
H . 75 11 318	16	6,2 x 19	24	3,44



## Primary

Silhouettes élégantes et galbées, elles distillent sur les tables une ambiance chaleureuse.



I . FH allongé



J . FH classique

Code	Ccl	Φ x Ht cm	Sur.	Prix HT
I . 75 07 390	40	7,6 x 12,7	24	2,62
J . 75 07 161	44	8,7 x 11	24	2,82
J . 75 07 162	36	8,1 x 10,2	24	2,62
J . 75 07 163	27	7,3 x 9,3	24	2,62

## Primary color

Sprays mat opaque



K . White



L . Black

Code	Ccl	Φ x Ht cm	Sur.	Prix HT
K . 75 07 396	36	8,1 x 10,2	24	5,00
L . 75 07 395	36	8,1 x 10,2	24	5,00

## Primary color

Sprays mat opaque



M . Emerald



N . Jade

Code	Ccl	Φ x Ht cm	Sur.	Prix HT
M . 75 07 397	36	8,1 x 10,2	24	5,00
N . 75 07 398	36	8,1 x 10,2	24	5,00



### Vins jeunes

Moderne et efficace avec une grande surface d'oxygénation, cette collection convient aux vins jeunes, rouges et blancs.



**A . Jauge naturelle à la cassure 16 cl**



**B . Jauge naturelle à la cassure 13 cl**



**C . Jauge naturelle à la cassure 10 cl**

Code	Ccl	Φ x Ht cm	Sur.	Prix HT
A . 75 10 447	58	10 x 22	24	4,16
B . 75 10 446	47	9,7 x 21	24	3,82

Code	Ccl	Φ x Ht cm	Sur.	Prix HT
C . 75 10 445	35	9 x 20	24	3,82

### Sensation exalt

Élégance et force pour un accord parfait.



**D .**



**E .**



**F .**



**G. Flûte**

Code	Ccl	Φ x Ht cm	Sur.	Prix HT
D . 75 10 672	41	8,6 x 20,5	24	3,82
E . 75 10 671	31	8 x 19,5	24	3,82
F . 75 10 670	25	7,4 x 18,5	24	3,62

Code	Ccl	Φ x Ht cm	Sur.	Prix HT
F . 75 10 669	20	7 x 18	24	3,62
G . 75 10 673	19	7 x 21	24	3,62



### Lima

Gobelet polygonal et contemporain. Fond lourd.



**H . Chope FB**



**I . Chope FH**



**J . Chope FH**



**K . Chope FH**

Code	Ccl	Φ x Ht cm	Sur.	Prix HT
H . 75 06 238	35	9,4 x 8	24	2,60
I . 75 06 239	38	8,8 x 11	24	2,60

Code	Ccl	Φ x Ht cm	Sur.	Prix HT
J . 75 06 240	45	7,7 x 16	24	2,82
K . 75 06 242	40	7,7 x 13	24	2,60

## Cabernet tulip

Cabernet Tulip met en valeur les vins très boisés et d'acidité modérée. Une forme harmonieuse pour tous types de vins. Large choix de capacités.



A.



B.



C.



Code	Ccl	Φ x Ht cm	Sur.	Prix HT
A . 75 10 440	75	10,1 x 25,5	12	4,55
A . 75 10 418	58	9,5 x 23	24	4,16
B . 75 10 417	47	9 x 22	24	3,82

Code	Ccl	Φ x Ht cm	Sur.	Prix HT
C . 75 10 416	35	8,1 x 20,2	24	3,82
C . 75 10 415	25	7,2 x 18	24	3,62
C . 75 10 420	19	6,6 x 16,5	24	3,62



## Cabernet jaugé (grappe)

Esthétique et discrète, la jauge est élégante sans trop s'imposer. Cristallin



D . Vins jeunes

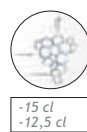

E . Cabernet Tulipe

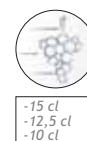

Code	Ccl	Φ x Ht cm	Sur.	Prix HT
D . 75 10 312	35	9 x 20	24	4,34

Code	Ccl	Φ x Ht cm	Sur.	Prix HT
E . 75 10 314	35	8,1 x 20,2	24	4,34

## Cabernet ballon

La rondeur favorise la dégustation des vins rouges aromatiques.



F.



G.



H.



I.



Code	Ccl	Φ x Ht cm	Sur.	Prix HT
F . 75 10 424	70	11,5 x 22,1	24	4,55
G . 75 10 423	58	10,6 x 20,9	24	4,16

Code	Ccl	Φ x Ht cm	Sur.	Prix HT
H . 75 10 422	47	10 x 19,6	24	3,82
I . 75 10 421	35	9,1 x 18,2	24	3,82

OGO

Présentation

OGO Living propose une verrerie élégante et durable, pensée pour l'usage quotidien des professionnels.

Des collections épurées en cristallin de haute qualité qui allient design, résistance et fonctionnalité pour sublimer chaque moment à table.



VAP Zénith

ZENITH est un verre cristallin élégant conçu pour sublimer le vin : sa forme met en valeur les arômes, son bord fin offre une sensation délicate et sa jambe élancée lui donne une allure raffinée, idéale pour la dégustation et le service.



A . Grand vin

Code	Ccl	Φ x Ht cm	Sur.	Prix HT
------	-----	-----------	------	---------

Boîte de 6 verres

A . 79 35 017	48	8 x 21,5	4	21,90
A . 79 35 016	35	7,2 x 20,5	4	20,75



B . Flûte

Code	Ccl	Φ x Ht cm	Sur.	Prix HT
------	-----	-----------	------	---------

Boîte de 6 verres

B . 79 35 015	25	6,5 x 19,5	4	20,40
B . 79 35 018	19	6 x 21,7	4	19,50

Chopes Zénith

Brillance ultime et tenue parfaite. Modernes et légèrement coniques.



C . FH



D . FB

Code	Ccl	Φ x Ht cm	Sur.	Prix HT
------	-----	-----------	------	---------

Boîte de 6 verres

C . 79 35 022	45	7,5 x 15	8	21,10
C . 79 35 021	45	8,5 x 11	8	21,10
D . 79 35 020	35	7,8 x 10,8	8	20,16

Neo

Sensation de la séduction du toucher des lèvres.



E .



F .



G .

Code	Ccl	Φ x Ht cm	Sur.	Prix HT
------	-----	-----------	------	---------

Boîte de 6 verres

E . 79 35 047	50	8,8 x 23,6	4	15,95
E . 79 35 046	40	8 x 22,2	4	14,50

Code	Ccl	Φ x Ht cm	Sur.	Prix HT
------	-----	-----------	------	---------

Boîte de 6 verres

F . 79 35 045	25	6,8 x 20,5	4	14,30
F . 79 35 048	20	6,5 x 22	4	14,30



### Astral

La collection Astral a été développée pour répondre aux besoins quotidiens des professionnels. Jambe courte pour une meilleure stabilité et un usage intensif. Son aspect flûté procure une élégance et confirme son design raffiné.



A .

B .

C .

Code	Ccl	Φ x Ht cm	Sur.	Prix HT
<u>Boîte de 6 verres</u>				
A . 79 35 052	50	8,8 x 23,1	8	16,70
B . 79 35 051	40	8 x 22	8	16,20

Code	Ccl	Φ x Ht cm	Sur.	Prix HT
<u>Boîte de 6 verres</u>				
C . 79 35 050	38	9,2 x 9,8	8	15,15



### Oslo

Classique, équilibré et très apprécié pour les tables de tous les jours, verre cristallin stable et solide.



D .

E .

F .

G . Flûte

Code	Ccl	Φ x Ht cm	Sur.	Prix HT
<u>Boîte de 6 verres</u>				
D . 79 35 027	45	6,6 x 20,8	8	13,95
E . 79 35 026	35	6,3 x 20,1	8	13,30

Code	Ccl	Φ x Ht cm	Sur.	Prix HT
<u>Boîte de 6 verres</u>				
F . 79 35 025	25	5,5 x 18,8	8	12,75
G . 79 35 028	20	4,9 x 21,1	8	12,80

Verres à pied



### Mondial

Mondial, l'icône intemporelle : souvent imitée, jamais égalée. L'essentiel des brasseries, bouillons et bouchons.

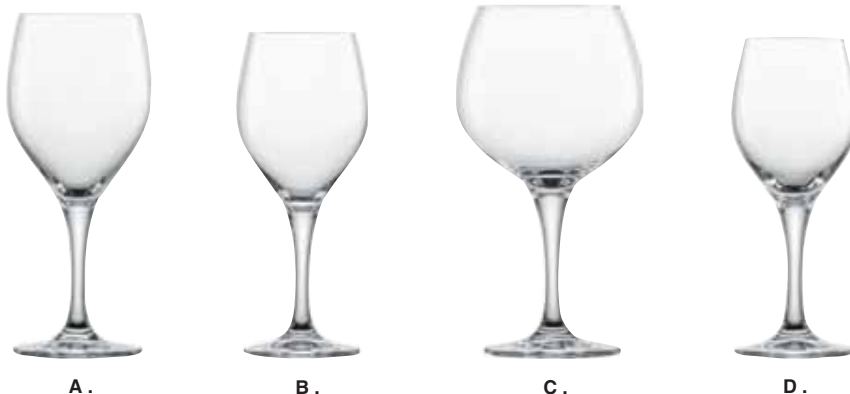

Code	n° - Ccl	Φ x Ht cm	Sur.	Prix HT
A . 75 43 350	1-44,5	8,8 x 20,5	6	4,06
B . 75 43 349	0-33,5	8,1 x 19,7	6	3,75

Code	n° - Ccl	Φ x Ht cm	Sur.	Prix HT
C . 75 43 352	140-61	10,7 x 19,5	6	4,17
D . 75 43 353	2-27	7,5 x 18,7	6	3,75

### Vina

Vina, le choix des sommeliers : durabilité exceptionnelle et expérience de dégustation incomparable.



Code	n° - Ccl	Φ x Ht cm	Sur.	Prix HT
E . 75 43 345	86-27,5	10,4 x 17	6	4,06
F . 75 43 357	7-21	7,2 x 21	6	3,99

Code	n° - Ccl	Φ x Ht cm	Sur.	Prix HT
G . 75 43 487	79-55,6	9 x 12,7	6	5,22
H . 75 43 481	42-39,7	8,1 x 11,4	6	5,17

Code	n° - Ccl	Φ x Ht cm	Sur.	Prix HT
I . 75 43 479	77-26,3	7 x 21,2	6	5,17
J . 75 43 477	7-22,7	7 x 22,5	6	5,17

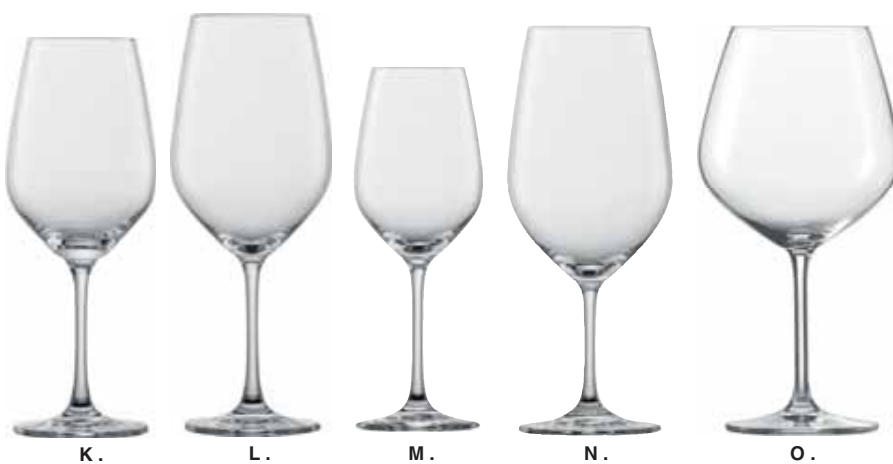

Code	n° - Ccl	Φ x Ht cm	Sur.	Prix HT
K . 75 43 470	0-40,4	8,2 x 21,47	6	5,06
L . 75 43 471	1-51,4	8,8 x 22,7	6	5,18
M . 75 43 475	2-27,9	7,3 x 20,3	6	5,17

Code	n° - Ccl	Φ x Ht cm	Sur.	Prix HT
N . 75 43 472	130-62,6	9,3 x 22,5	6	5,17
O . 75 43 474	140-73,2	11,1 x 22,1	6	5,17

## Ivento

Ivento, l'élégance accessible : grands volumes, jambes élancées et une allure raffinée à prix compétitif.

SCHOTT  
ZWIESEL

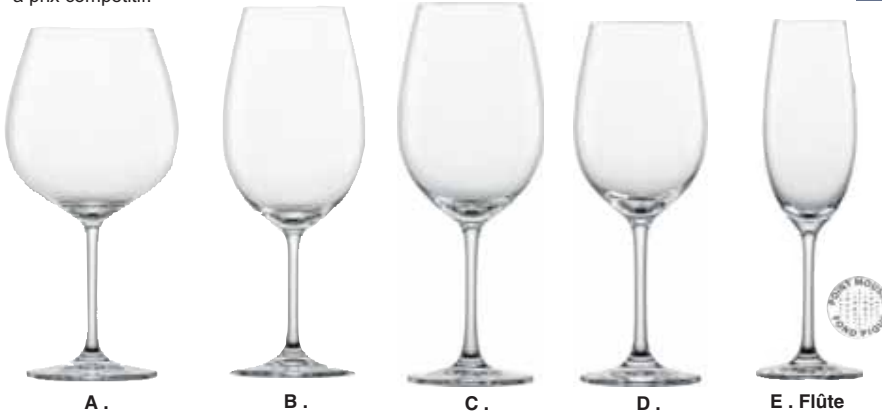

Code	n° - Ccl	Φ x Ht cm	Sur.	Prix HT
A . 75 43 320	140-78	11,1 x 22,1	6	3,99
B . 75 43 321	130-63	9,2 x 23,5	6	3,99
C . 75 43 322	1-50	8,7 x 22,4	6	3,99

Code	n° - Ccl	Φ x Ht cm	Sur.	Prix HT
D . 75 43 323	0-35	7,7 x 20,8	6	3,99
E . 75 43 324	7-23	7 x 22,2	6	3,99

## Belfesta / Pure

Belfesta, l'alliance de la polyvalence et du style : silhouette diamantée, jambes longues et une gamme complète pour des tables élégantes.

ZWIESEL  
GLAS



Code	n°-Ccl	Φ x Ht cm	Sur.	Prix HT
F . 75 43 403	130-68	9,4 x 26,7	6	6,23
F . 75 43 400	1-54	9,2 x 24,4	6	6,23
G . 75 43 401	0-41	8,4 x 23,2	6	6,23
G . 75 43 402	2-30	7,6 x 22	6	5,87

Code	n°-Ccl	Φ x Ht cm	Sur.	Prix HT
H . 75 43 404	140-69,2	11,4 x 23,4	6	6,23
H . 75 43 409	145-46,5	9,8 x 22,2	6	6,23
I . 75 43 410	7-20,9	7,2 x 25,2	6	5,87
I . 75 43 412	77-29,7	7,2 x 23,4	6	6,23

Code	n°-Ccl	Φ x Ht cm	Sur.	Prix HT
J . 75 43 429	42-35,7	7 x 14,4	6	5,21
K . 75 43 437	89-30,6	8,9 x 8,3	6	5,21
K . 75 43 433	60-38,9	9,6 x 9	6	5,21

## Favorit

Favorit, le verre incontournable des bistros : conçu pour la bistronomie et les bars.

SCHOTT  
ZWIESEL

## The One

design audacieux et stabilité hors pair grâce à son centre de gravité abaissé.



L . Favorit

M . The One

Code	Ccl	Φ x Ht cm	Sur.	Prix HT
L . 75 43 626	27	7,2 x 18,1	6	2,70

Code	Ccl	Φ x Ht cm	Sur.	Prix HT
M . 19 71 747	41,3	9 x 21,1	6	25,47
M . 19 71 748	32	8 x 19	6	21,93

Boîte de 6 verres



La note de musique

**TRITAN**® GLASS  
PROTECT

Tritan Crystal Glass

Résistance - Éclat - Éléance

Le processus de fabrication renforce les 3 zones sensibles : le buvant, le haut et la base du pied du verre.

Extrêmement résistant à la casse, aux rayures et à la brisure.

# SENSA

Collection by ZWIESEL



Sensa gamme d'arômes typique





### Taste

La jambe est très bien étirée, la finesse du verre est unique. Pour les fins gourmets, une série intemporelle.



Code	n°-Ccl	Φ x Ht cm	U.V	Prix HT
A . 75 43 491	140-79	11,1 x 22,7	1/6	4,75
B . 75 43 490	130-65,6	9,6 x 23,7	1/6	4,75
C . 75 43 492	1-49	8,7 x 22,5	1/6	4,85

Code	n°-Ccl	Φ x Ht cm	U.V	Prix HT
D . 75 43 493	0-35,6	7,9 x 21,1	1/6	4,85
E . 75 43 496	0-28,3	7 x 23,1	1/6	4,95

### Ever / Classico

Le raffinement et la simplicité de ces verres solides conviennent à une multitude d'événements.



Code	n°-Ccl	Φ x Ht cm	U.V	Prix HT
F . 75 43 076	0-40,8	8,2 x 22,5	1/6	5,45
F . 75 43 081	2-31,2	7,5 x 21	1/6	4,46
G . 75 43 077	1-54,5	9 x 24	1/6	5,35

Code	n°-Ccl	Φ x Ht cm	U.V	Prix HT
G . 75 43 078	130-64,5	7,5 x 21	1/6	5,35
H . 75 43 080	140-81,4	11,6 x 23	1/6	5,45



### Sensa

Chaque forme correspond à un arôme ou à un style de vin.



I . Sensus noir

Code	Ccl	Φ x Ht cm	U.V	Prix HT
I . 75 43 549	29,9	7,5 x 18,2	1/6	6,45



J . Crachoir

Code	Φ x Ht cm	U.V	Prix HT
J . 75 43 551	15,8 x 27,2	1	60,40



K .



L .

Code	Ccl	Φ x Ht cm	Sur.	Prix HT
K . 75 43 171	53	8,8 x 23,6	6	6,85
K . 75 43 172	36	7,6 x 22,2	6	6,85
L . 75 43 174	50	8,4 x 12	6	6,72

Verres à pied



Propriété du verre Ultra Clair Sparkx®



Verre Ultra Clair résistant, sans métaux lourds, conforme à la norme ISO/PAS IWA 8 : 2009. Jambe tirée dans la même goutte de verre que la paraison (pas de joints ni coutures). Bord mince coupé laser. Jambe renforcée Titane. Grande résistance. Garantie à plus de 2.000 cycles de lavage industriel sans altération de la transparence et de la brillance. Eco-respectueux (sans plomb ni autres métaux lourds).

Traitement Titane

**TITANIUM Reinforced** Procédé de renforcement nanotechnologique à base de titane en application directe sur la jambe. Il durcit considérablement la surface du verre et augmente sa résistance à l'abrasion (évite les micro-rayures des jambes à terme). Résistance de la jambe à la rupture augmentée de 140%. Parfaitement incolore et transparent.

Rubino

Le verre œnologique pratique pour la table et la dégustation.



A . Eau

Code	Ccl	Φ x Ht cm	Sur.	Prix HT
A . 75 36 127	37	8,1 x 18,1	24	4,07
A . 75 36 125	27	7,3 x 17,1	24	3,94



Michelangelo

Le verre à jambe tirée d'inspiration artistique en verre ultra clair. Soufflé mécanique, bord mince et résistant.



B . Eau



C . Vin



D . Flûte

Code	Ccl	Φ x Ht cm	Sur.	Prix HT
B . 75 36 009	34	8,2 x 18,8	24	4,29
B . 75 36 010	22,5	7,3 x 17,5	24	3,85

Code	Ccl	Φ x Ht cm	Sur.	Prix HT
C . 75 36 011	19	6,7 x 16,6	24	3,59
D . 75 36 014	16	6,4 x 18,5	24	3,94



D.O.C

Le verre de table "œnologue".



E . Dream



F . Coupe



H .

Code	Ccl	Φ x Ht cm	Sur.	Prix HT
E . 75 36 105	14	6 x 17	2	3,40
F . 75 36 015	22	9,5 x 14	24	4,20

Code	Ccl	Φ x Ht cm	Sur.	Prix HT
H . 75 36 041	21,5	6,5 x 15,5	24	3,52
H . 75 36 042	31	7,3 x 17,4	24	4,07

## Mixology

Une ligne au design vintage et raffiné. La présentation et la rondeur ludique enivreront vos soirées bar.

ACCADEMIA *L'Arte del Cristallo*  
VERRE



A . Nick&Nora



B . Coupe



C . Martini

Code	Ccl	Φ x Ht cm	Sur.	Prix HT
A . 75 36 247	15	6,9 x 14,7	24	3,59
B . 75 36 249	22,5	9,5 x 14	24	4,39
C . 75 36 248	21,5	10,4 x 17,2	24	5,38



D . Gin tonic



E . Spritz



F . Cognac

Code	Ccl	Φ x Ht cm	Sur.	Prix HT
D . 75 36 251	80	11,9 x 20,5	12	6,52
E . 75 36 250	57	9,1 x 22,5	24	5,66
F . 75 36 255	46	9,7 x 12,7	12	5,72

## Diamante

Pour une décoration ludique, vintage et raffinée et une joyeuse animation de votre bar !

ACCADEMIA *L'Arte del Cristallo*  
VERRE



G . Gin tonic



H . Eau et vin



I . Flûte

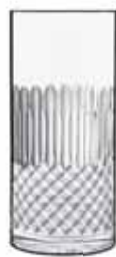

J . Chope FH



K . Chope FB

Code	Ccl	Φ x Ht cm	Sur.	Prix HT
G . 75 36 268	65	11 x 22,3	24	6,80
H . 75 36 267	52	9,4 x 23,5	24	6,34
H . 75 36 266	38	8,5 x 21,5	24	5,81

Code	Ccl	Φ x Ht cm	Sur.	Prix HT
I . 75 36 265	22	7 x 23,6	24	5,76
J . 75 36 269	48	7,2 x 15,7	24	6,32
K . 75 36 253	38	8,4 x 9,6	24	5,03



## Verres à pied

## Bach

Design vintage et tendance, élégant et raffiné, allié à la jambe tirée renforcée titane et aux qualités du cristallin SON.hyx®



A . Cocktail



B . Fizz



C . Gin tonic



D . Vin

Code	Ccl	Φ x Ht cm	Sur.	Prix HT
A . 75 36 473	26	11,3 x 18,5	16	6,56
B . 75 36 477	26	9,7 x 15,7	16	5,42

Code	Ccl	Φ x Ht cm	Sur.	Prix HT
C . 75 36 476	60	10,7 x 20,1	16	6,25
D . 75 36 468	28	7 x 20,6	24	5,74



E . Eau



F . Flûte

Code	Ccl	Φ x Ht cm	Sur.	Prix HT
E . 75 36 467	40	7,7 x 22	24	6,14
F . 75 36 469	21	5,3 x 23,5	24	5,47



G . Chope FH  
à facettes fond lourd :  
design scandinave



H . Chopes FB  
à facettes fond lourd :  
design scandinave

Code	Ccl	Φ x Ht cm	Sur.	Prix HT
G . 75 36 472	36	6,4 x 15,5	24	4,42
H . 75 36 470	25,5	7,5 x 9	24	4,26
H . 75 36 471	33,5	8,25 x 9,7	24	4,77



## Le cristallin SON.hyx®

Cristallin soufflé mécanique sans plomb haute technologie. Jambe tirée dans la même goutte de verre que la paraison (pas de joints ni coutures), bord mince coupé laser. Brillant, parfaitement incolore et transparent (totalement perméable à la lumière). Haute sonorité grande résistance. Garantie à plus de 4.000 cycles de lavages industriels.

## Supremo

L'aboutissement de recherches en design et créativité. Supremo allie l'extrême raffinement aux plus grandes qualités de la dégustation. Transparence parfaite, brillance éclatante, sonorité et résistance du cristallin SON.hyx®

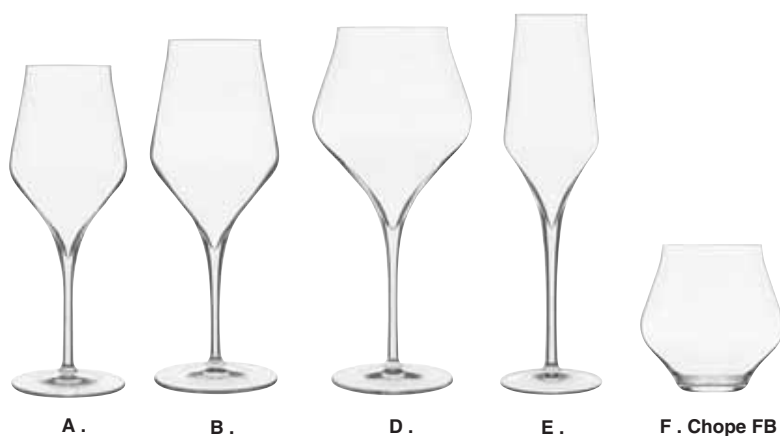

Code	Ccl	Φ x Ht cm	Sur.	Prix HT	Code	Ccl	Φ x Ht cm	Sur.	Prix HT
A . 75 36 460	35	8,1 x 22,1	24	5,50	D . 75 36 458	65	11 x 24,5	12	6,58
B . 75 36 459	45	8,8 x 23,3	24	5,76	E . 75 36 461	24	6,4 x 25	24	5,15
B . 75 36 462	55	9,5 x 24,3	12	6,14	F . 75 36 463	45	10 x 9,8	24	3,62



## Roma 1960

Le charme et la volupté italienne des bars 60's : la bague en taille « panier » encercle le bas des paraisons.

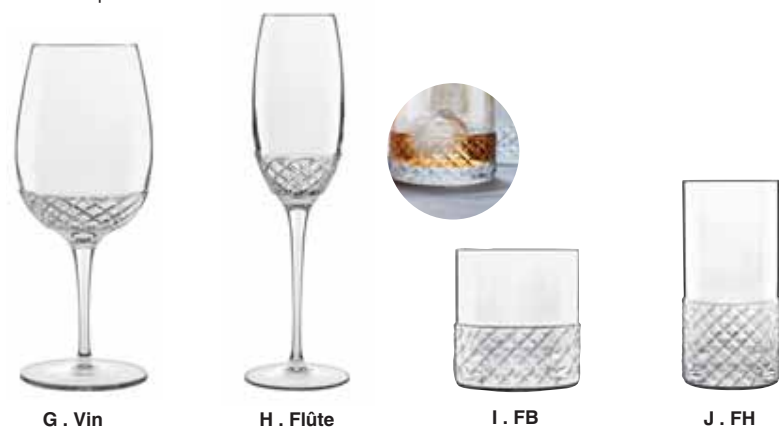

Code	Ccl	Φ x Ht cm	Sur.	Prix HT	Code	Ccl	Φ x Ht cm	Sur.	Prix HT
G . 75 36 258	55	9 x 22,2	24	5,72	I . 75 36 262	30	8 x 8,4	24	4,64
H . 75 36 264	24	7 x 24,4	24	4,96	J . 75 36 263	40	7 x 14,2	24	5,03

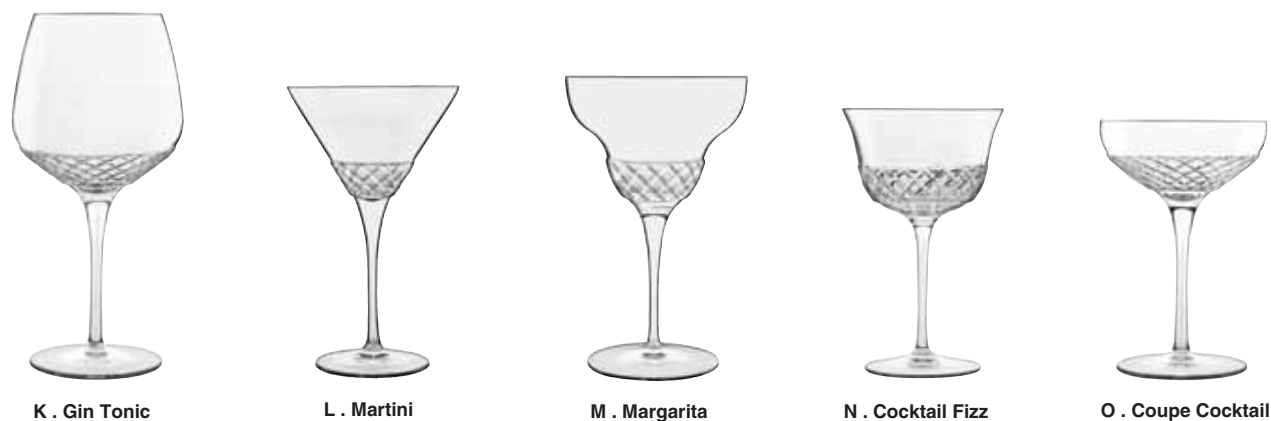

Code	Ccl	Φ x Ht cm	Sur.	Prix HT	Code	Ccl	Φ x Ht cm	Sur.	Prix HT	Code	Ccl	Φ x Ht cm	Sur.	Prix HT
K . 75 36 259	80	11,4 x 23,5	12	6,42	M . 75 36 261	39	11,4 x 18,4	12	6,23	N . 75 36 256	26	9,6 x 15,7	24	5,15
L . 75 36 260	22	10,4 x 17,2	24	5,62						O . 75 36 257	30	11,3 x 15	12	6,00

# MIXOLOGY

Collection by Bormioli Luigi



L'art de sublimer les cocktails

*Luigi Bormioli*  
MADE IN ITALY

## Backdoor '20s

Des courbes généreuses pour un enivrement immédiat et une dégustation agréable de vos boissons.

Lugli Bormioli  
MADE IN ITALY



A . Barracuda



B . Great Gastby



C . Hemingway



D . Nick Nora



E . Gin Tonic



F . Tequila

Code	Ccl	Φ x Ht cm	Sur.	Prix HT
A . 75 36 290	32	8,1 x 20	12	5,13
B . 75 36 289	30	10,5 x 16,2	12	5,13

Code	Ccl	Φ x Ht cm	Sur.	Prix HT
C . 75 36 288	25	10,5 x 16	12	5,63
D . 75 36 287	17	8,6 x 14,6	12	4,63

Code	Ccl	Φ x Ht cm	Sur.	Prix HT
E . 75 36 291	80	8,6 x 23,5	12	6,84
F . 75 36 292	42	7,3 x 19,8	12	5,63

## Speakeasy

Le jeu de lumière et de lignes sur une forme épurée pour compléter Meravigliosi.

Lugli Bormioli  
MADE IN ITALY



G . Vin blanc / Eau pétillante



H . Coupe



J . FB

Code	Ccl	Φ x Ht cm	Sur.	Prix HT
G . 75 36 566	55	9,3 x 22,7	24	7,98
H . 75 36 564	30	10,7 x 14,8	24	7,98

Code	Ccl	Φ x Ht cm	Sur.	Prix HT
J . 75 36 559	40	9,5 x 10,2	24	7,53



## Meravigliosi

Une nouvelle forme simple et parfaite.



K . Coupe



L . Sauterne



M . Chardonnay



N . Cabernet



O . Flûte

Code	Ccl	Φ x Ht cm	Sur.	Prix HT
K . 75 36 556	30	10,7 x 14,8	24	4,99
L . 75 36 551	35	8 x 20,3	24	3,91
M . 75 36 550	45	8,8 x 21,6	24	4,42

Code	Ccl	Φ x Ht cm	Sur.	Prix HT
N . 75 36 554	70	10,7 x 24,3	24	5,34
O . 75 36 555	40	7,8 x 24,5	24	4,35



Verres à pied

**Timeless**

Une ligne intemporelle au style moderne et incomparable, inspirant les professionnels pour les cocktails et spiritueux.



**A . FH**



**B . FB**



**C . FB**

Code	Ccl	Φ x Ht cm	Sur.	Prix HT
<u>Boîte de 6 verres</u>				
A . 19 46 261	44	7,6 x 15	2	28,68
B . 19 46 260	36	8,6 x 9,2	2	24,48

Code	Ccl	Φ x Ht cm	Sur.	Prix HT
<u>Boîte de 6 verres</u>				
C . 19 46 259	31	8,3 x 8,6	2	23,61



**D . Martini**



**E . Spritz**



**F . Cocktail**

Code	Ccl	Φ x Ht cm	Sur.	Prix HT
<u>Boîte de 6 verres</u>				
D . 19 46 271	21	10,3 x 18	2	32,14
E . 19 46 270	36	9,6 x 22	2	30,51

Code	Ccl	Φ x Ht cm	Sur.	Prix HT
<u>Boîte de 4 verres</u>				
F . 19 46 273	50	10,3 x 20,8	2	25,91



**G . Calice**



**H . Eau**



**I . Vin**



**J . Flûte**

Code	Ccl	Φ x Ht cm	Sur.	Prix HT
<u>Boîte de 6 verres</u>				
G . 19 46 272	26	10 x 16,7	2	34,64

Code	Ccl	Φ x Ht cm	Sur.	Prix HT
<u>Boîte de 6 verres</u>				
H . 19 46 263	30	8,9 x 20,9	2	34,64
I . 19 46 262	23	8,1 x 20	2	30,51

Code	Ccl	Φ x Ht cm	Sur.	Prix HT
<u>Boîte de 6 verres</u>				
J . 19 46 264	21	7,1 x 23,8	2	34,64

RCR



Présentation

RCR puise son origine au fond de la Toscane (Italie), en 1967, fabrication 100% dans l'usine. Issue de la tradition verrière italienne (verres pressés et soufflés), RCR s'est créé autour de la tradition artisanale locale. Grâce à ses nouveautés, RCR consolide son image avec un accent de modernité et de créativité. La gamme RCR a un succès fort en Europe depuis plusieurs années avec des gammes intemporelles mais aussi fonctionnelles, pratiques et tendance.

Le verre RCR

La collection forme une alchimie entre Barware Mixology et verres de table : des verres solides qui trouvent leur place sur toutes les tables.



Luxion® Crystal Glass :

Tous les produits sont fabriqués en Luxion®, le crystal glass breveté et recyclable à l'infini de RCR. L'utilisation d'oxydes nobles dans sa formule assure un haut niveau de qualité immédiatement visible à l'œil nu et perceptible dans la force, la transparence, la brillance et la sonorité des produits

Certifications:

- ISO 9001 : 2015
- ISO 14001 : 2015

Tattoo

Une ligne jeune, avec un style contemporain qui rappelle les lignes esthétiques du Body Art.



A . FH



B . FB



C . Mixing

Code	Ccl	Φ x Ht cm	Sur.	Prix HT
<b>Boîte de 6 verres</b>				
A . 19 46 372	37	7 x 15	2	28,68
B . 19 46 371	34	8,2 x 9,4	2	24,48

Code	Ccl	Φ x Ht cm	Sur.	Prix HT
<b>Pièce</b>				
C . 19 46 365	65	9,7 x 16	4	18,15



D . Calice



E . Coupette

Code	Ccl	Φ x Ht cm	Sur.	Prix HT
<b>Boîte de 6 verres</b>				
D . 19 46 373	29	8,8 x 19,4	2	34,64
E . 19 46 375	27	10 x 14	2	34,64



Stack

Empilables au design moderne.



F . FH



G . FB

Code	Ccl	Φ x Ht cm	Sur.	Prix HT
<b>Boîte de 6 verres</b>				
F . 19 46 028	39	8,3 x 14,1	2	29,37
G . 19 46 027	31	8,9 x 9,5	2	25,71

Verres à pied

### Alkemist

D'inspiration des sculptures de pierres précieuses pour une ligne unique et inimitable. Le style des années 30 pour magnifier l'apéritif et les cocktails.



A .

B .



C .

D .

Code	Ccl	Φ x Ht cm	Sur.	Prix HT
------	-----	-----------	------	---------

Boîte de 6 verres

A . 19 46 187	58	10,8 x 20,8	2	36,62
B . 19 46 188	53	10 X 22,5	2	39,16

Code	Ccl	Φ x Ht cm	Sur.	Prix HT
------	-----	-----------	------	---------

Boîte de 6 verres

C . 19 46 186	38	8,7 x 9,5	2	26,68
D . 19 46 185	35	8,7 x 10,3	2	29,18



### Etna

Etna s'inspire de la puissance de l'éruption du volcan sicilien. La parfaite imperfection de la nature est gravée sur les décors qui caractérisent verres et gobelets : la lumière se reflète sur les gravures se multipliant sur plusieurs niveaux, accentuant la transparence exceptionnelle.



E . Chope FH



F . Chope FB

Code	Ccl	Φ x Ht cm	Sur.	Prix HT
------	-----	-----------	------	---------

Boîte de 6 verres

E . 19 46 214	34	7 x 15	2	29,37
---------------	----	--------	---	-------

Code	Ccl	Φ x Ht cm	Sur.	Prix HT
------	-----	-----------	------	---------

Boîte de 6 verres

F . 19 46 213	33	8 x 9,5	2	25,71
---------------	----	---------	---	-------



G .



H .



I . Flûte

Code	Ccl	Φ x Ht cm	Sur.	Prix HT
------	-----	-----------	------	---------

Boîte de 6 verres

G . 19 46 216	28	8,5 x 19	2	35,51
H . 19 46 215	20	8 x 18,5	2	30,91

Code	Ccl	Φ x Ht cm	Sur.	Prix HT
------	-----	-----------	------	---------

Boîte de 6 verres

I . 19 46 217	19	7 x 22,5	2	35,51
---------------	----	----------	---	-------



## Tiki

Cocktail esprit anciens peuples italiens.  
2 nouveautés en 2016



**A . Pulcinella**  
(lot de 4)



**B . Venezia**  
(lot de 4)



**D . Sardinia**  
(lot de 4)



**E . Etruria**  
(lot de 4)

Code	Ccl	Φ x Ht cm	Sur.	Prix HT
------	-----	-----------	------	---------

Boîte de 4 verres

A . 19 46 032	45	7,6 x 13,6	2	34,44
B . 19 46 033	45	7,6 x 13,6	2	34,44

Code	Ccl	Φ x Ht cm	Sur.	Prix HT
------	-----	-----------	------	---------

Boîte de 4 verres

D . 19 46 025	46	7,6 x 13,6	2	34,44
E . 19 46 026	45	7,6 x 13,6	2	34,44

## Melodia

Une ligne éternelle, rassurante et polyvalente.  
Le style mixologie donne de la structure à la table et à tous les styles de cocktail.



**E . Chope FH**



**F . Chope FB**



**G . Eau**

Code	Ccl	Φ x Ht cm	Sur.	Prix HT
------	-----	-----------	------	---------

Boîte de 6 verres

E . 19 46 246	36	7 x 15	2	28,68
F . 19 46 245	31	8,2 x 9,4	2	24,48

Code	Ccl	Φ x Ht cm	Sur.	Prix HT
------	-----	-----------	------	---------

Boîte de 6 verres

G . 19 46 249	27	8,7 x 20,2	2	34,64
---------------	----	------------	---	-------



**H . Vin**



**I . Liqueur**



**J . Flûte**

Code	Ccl	Φ x Ht cm	Sur.	Prix HT
------	-----	-----------	------	---------

Boîte de 6 verres

H . 19 46 248	21	8,2 x 19	2	30,51
I . 19 46 247	6	9 x 15	2	30,51

Code	Ccl	Φ x Ht cm	Sur.	Prix HT
------	-----	-----------	------	---------

Boîte de 6 verres

J . 19 46 250	16	7 x 22,2	2	34,64
---------------	----	----------	---	-------



New products  
Nouveautés

# VINA & V.JULIETTE

Collections by ARCOROC



une taille qui offre un grand confort de dégustation.

**ARCOROC**

ARCOROC

MADE IN FRANCE

CRYSTAL GLASS HIGH QUALITY

Cela fait partie du quotidien et de chaque service. Arcoroc créer des produits d'art de la table depuis 1958  
 En 2026, un nouveau chapitre s'ouvre pour Arcoroc avec le lancement du verre en Cristallin de haute qualité : raffinement et robustesse pour les lieux où le style se mêle à l'art du service.

CRYSTAL GLASS HIGH QUALITY

Arcoroc a développé une gamme de solutions d'art de la table innovantes et fonctionnelles, conçues pour un usage intensif en restauration.



- 1) Résistance supérieure
- 2) Transparence totale
- 3) Acoustique parfaite
- 4) Brillance durable



## Disco

Design aux fines lignes lumineuses, inspirer des reflets festifs avec une élégance contemporaine, Disco magnifie les couleurs des boissons.

ARCOROC  
CRYSTAL GLASS HIGH QUALITY



A . Gin Tonic



B . Nick & Nora



C . Coupe

Code	Ccl	Φ x Ht cm	Sur.	Prix HT
A . 75 11 345	60	10 x 21,5	12	4,27
B . 75 11 346	18	7,5 x 17	12	3,77

Code	Ccl	Φ x Ht cm	Sur.	Prix HT
C . 75 11 347	21	9 x 16	12	3,77



D . PH



E . FB



F . FB

Code	Ccl	Φ x Ht cm	Sur.	Prix HT
D . 75 06 512	45	8,5 x 13,5	12	2,36
E . 75 06 511	38	9,5 x 9	12	2,36

Code	Ccl	Φ x Ht cm	Sur.	Prix HT
F . 75 06 510	32	9 x 8,5	12	2,15

New products  
Nouveautés



## V. Juliette

La forme angulaire simple et légère sur un verre d'une très grande transparence à bord mince proche du cristallin.

ARCOROC

CRYSTAL GLASS  
HIGH QUALITY



A .



B .



C . Jaugé Grappe

Code	Ccl	Φ x Ht cm	Sur.	Prix HT
A . 75 10 355	50	9,2 x 21,7	24	3,58
A . 75 10 356	40	8,6 x 20,6	24	3,58

Code	Ccl	Φ x Ht cm	Sur.	Prix HT
B . 75 10 357	30	7,9 x 18,8	24	3,28
C . 75 10 313	30	7,9 x 18,8	24	3,82



D . Flûte



E . Gobelet FH léger



F . Gobelet FB léger

Code	Ccl	Φ x Ht cm	Sur.	Prix HT
D . 75 10 358	23	6,5 x 21,7	24	3,28

Code	Ccl	Φ x Ht cm	Sur.	Prix HT
E . 75 06 432	40	8,7 x 11	24	2,02
F . 75 06 430	35	9,4 x 8,3	24	2,02



## Magnifique

Très proche du cristallin, une forme généreuse. Idéal pour le vin au verre. Bord mince et grande pureté. Deux tailles désormais.

ARCOROC

CRYSTAL GLASS  
HIGH QUALITY



G .



H .

Code	Ccl	Φ x Ht cm	Sur.	Prix HT
G . 75 10 962	47	9,7 x 22,7	12	3,57

Code	Ccl	Φ x Ht cm	Sur.	Prix HT
H . 75 10 961	35	9 x 21	24	3,28

## Broadway et Broadway bleu

Collection remise au goût du jour ! Elle joue avec les lumières des bars et des pubs.  
Verre non trempé.

ARCOROC  
CRYSTAL  
GLASS  
HIGH QUALITY



K . VAP Table



L . Martini



M . Gin



N . Coupe

Code	Ccl	Φ x Ht cm	Sur.	Prix HT
K . 75 11 513	25	8,9 x 18,8	24	4,81
L . 75 11 510	21	11,8 x 15,5	24	5,05

Code	Ccl	Φ x Ht cm	Sur.	Prix HT
M . 75 11 512	58	10,7 x 19,5	24	5,47
N . 75 11 511	25	11,5 x 13,8	24	4,81



■ Teintée dans la masse



H . Chope FH



H . Chope FH



I . Chope FB



J . Bleu



J . Mauve

Code	Ccl	Φ x Ht cm	Sur.	Prix HT
H . 75 07 306	38	7,5 x 14,5	24	3,63
H . 75 07 303	28	6,75 x 13,4	24	3,11

Code	Ccl	Φ x Ht cm	Sur.	Prix HT
I . 75 07 304	30	8,45 x 9,1	24	3,09

Code	Ccl	Φ x Ht cm	Sur.	Prix HT
J . 75 07 329	30	8,45 x 9,1	24	3,39
J . 75 07 328	30	8,45 x 9,1	24	3,39

## West Loop

Design iconique. Aspect cristal taillé Longchamp très serré : brillance sur table ou dans les bars.  
Jambe travaillée, sculptée finement.  
Collection conçue pour des cocktails surprenants.

ARCOROC  
CRYSTAL  
GLASS  
HIGH QUALITY



K . Vap Eau



L . Flûte



M . Vodka



N . Gobelet FH



O . Gobelet FB

Code	Ccl	Φ x Ht cm	Sur.	Prix HT
K . 75 10 813	25	7,4 x 18,2	12	4,55
L . 75 10 814	14	5,3 x 20,5	12	4,55
M . 75 11 213	27	11,3 x 16,8	12	5,70

Code	Ccl	Φ x Ht cm	Sur.	Prix HT
N . 75 06 477	36	7,5 x 13,5	12	3,91
O . 75 06 476	32	8,4 x 9,5	12	3,51

## Verres à pied

## Vina

La paraison tulipée. Un classique pour tous les vins.

ARCOROC



A.



B.



C . Gin



D . Splendid

Code	Ccl	Φ x Ht cm	Sur.	Prix HT
A . 75 10 028	58	9,3 x 23	24	3,66
A . 75 10 033	47	8,8 x 21,9	24	3,20
B . 75 10 032	36	8 x 20,2	24	3,20
B . 75 10 031	26	7,2 x 18	24	2,97

Code	Ccl	Φ x Ht cm	Sur.	Prix HT
C . 75 10 043	70	11,3 x 19,5	12	4,17
D . 75 10 806	58	10,6 x 20,9	24	3,66



E . Flûte



F . Chope FH



G . Chope FB

Code	Ccl	Φ x Ht cm	Sur.	Prix HT
E . 75 10 034	19	5,5 x 22,5	24	2,97

Code	Ccl	Φ x Ht cm	Sur.	Prix HT
F . 75 06 033	36	7,6 x 12,1	24	1,82
G . 75 06 032	34	8,9 x 8,3	24	1,82



H . Viticole



I . Viticole

Code	Ccl	Φ x Ht cm	Sur.	Prix HT
H . 75 11 024	31	7,2 x 17,5	6	3,20
H . 75 11 029	21,5	6,5 x 15,5	24	2,53
I . 75 11 028	12	5,4 x 13,1	6	2,36

## Equip Home

Luminarc

Verre non trempé.



J.

K.  
Flûte

Code	Ccl	Φ x Ht cm	Sur.	Prix HT
J . 10 29 831	35	6,4 x 19,2	24	2,45
J . 75 10 829	24	7 x 16,9	24	2,05
J . 75 10 830	19	5,3 x 15,4	24	1,90
K . 75 10 831	17	6 x 17,5	24	2,05

## Ballon

ARCOROC

Verre non trempé.



L.

Code	Ccl	Φ x Ht cm	Sur.	Prix HT
L . 75 10 012	25	8,4 x 13,8	24	2,22
L . 75 10 013	19	7,7 x 13	24	2,10

## Roman

Luminarc

Verre non trempé.



M.



N.

Code	Ccl	Φ x Ht cm	Sur.	Prix HT
M . 75 10 380	21,5	8,0 x 11,7	24	2,45
N . 75 10 381	14	7,1 x 10,4	24	2,30



## Silhouette

Capacités et épaisseur du verre. Taille réduite pour le restauration rapide.



A .



B .



C . Flûte

Code	Ccl	Φ x Ht cm	Sur.	Prix HT
A . 75 11 328	47	9,2 x 19,4	24	3,21
A . 75 11 327	31	8,2 x 17,1	24	3,21
A . 75 11 326	25	8,2 x 17,1	24	2,97

Code	Ccl	Φ x Ht cm	Sur.	Prix HT
B . 75 11 325	19	7 x 15,3	24	2,76
C . 75 11 329	18	6,4 x 18,1	24	2,98

## Élégance

Verre non trempé.



D . Eau



E . Vin rouge



F . Vin blanc / Porto



G . Coupe



H . Flûte



I . Hurrigan

Code	Ccl	Φ x Ht cm	Sur.	Prix HT
D . 75 11 260	31	8,1 x 18	36	3,21
D . 75 11 258	24,5	7,4 x 16,6	48	2,97
E . 75 11 262	19	6,9 x 15,3	48	2,76
<b>Emballages promotion cartons 48 verres</b>				
D . 75 10 701	24,5	7,4 x 16,6	48	2,74
E . 75 10 702	19	6,9 x 15,3	48	2,42

Code	Ccl	Φ x Ht cm	Sur.	Prix HT
F . 75 11 263	14,5	6,4 x 14,2	48	2,50
F . 75 11 264	12	5,9 x 13,4	48	2,50
F . 75 10 065	6,5	4,8 x 11,3	48	2,35
G . 75 11 270	16	9,0 x 12,2	48	3,21

Code	Ccl	Φ x Ht cm	Sur.	Prix HT
H . 75 11 266	10	4,7 x 15,9	48	2,50
H . 75 11 267	13	4,7 x 17,9	48	2,76
H . 75 11 269	17	5,5 x 17,5	48	2,98
I . 75 10 059	44	7,9 x 20,7	24	6,59

## Savoie

Verre non trempé.

ARCOROC

L .  
Eau  
/ VinM .  
PortoN .  
Flûte

Code	Ccl	Φ x Ht cm	Sur.	Prix HT
L . 75 10 035	24,5	7,4 x 15,2	48	2,24
L . 75 10 036	19	6,9 x 14	48	2,09
M . 75 10 037	14,5	6,4 x 13,4	48	1,91
N . 75 10 040	17	6,1 x 17	48	2,24



Verres à pied



**Elisa**

Verre trempé Arcoroc.

ARCOROC



A .



B .



C .



D . Flûte

Code	Ccl	Φ x Ht cm	Sur.	Prix HT
A . 75 10 614	30	7,64 x 19,4	24	3,51
B . 75 10 615	23	7,2 x 17,6	48	3,28

Code	Ccl	Φ x Ht cm	Sur.	Prix HT
C . 75 07 147	23	7,1 x 8,2	24	1,61
D . 75 10 617	17	5,3 x 19,2	48	3,28



**Amélia**

Verre trempé empilable Arcoroc.



D .



E .



F .

Code	Ccl	Φ x Ht cm	Sur.	Prix HT
D . 75 10 537	25	7,9 x 11,7	48	3,9
E . 75 10 536	19	7,2 x 10,6	48	2,98

Code	Ccl	Φ x Ht cm	Sur.	Prix HT
F . 75 10 535	16	6,1 x 10,1	48	2,98



**Normandie**

Verre trempé Arcoroc.



G .



H .



I . Flûte

Code	Ccl	Φ x Ht cm	Sur.	Prix HT
Emballages cartons 12/48				
G . 75 10 500	23	7,4 x 16,2	48	3,52
H . 75 10 501	16,5	6,7 x 14,5	48	3,33
I . 75 10 504	15	5,4 x 17,3	48	3,33

Code	Ccl	Φ x Ht cm	Sur.	Prix HT
Emballages cartons 48 verres				
G . 75 10 800	23	7,4 x 16,2	48	3,43
H . 75 10 801	16,5	6,7 x 14,5	48	3,12
I . 75 10 804	15	5,4 x 17,3	48	3,12



## Domaine

Adaptée pour le banqueting, Domaine est une collection ergonomique, solide, un excellent rapport qualité prix. Verre trempé.

ARCOROC

EXTRA  
RESISTANT



A .



B .

Code	Ccl	Φ x Ht cm	Sur.	Prix HT
A . 75 10 948	47	9 x 22,4	12	3,73

Code	Ccl	Φ x Ht cm	Sur.	Prix HT
B . 75 10 947	37	8,3 x 20,2	24	3,50
B . 75 10 946	27	7,6 x 18,2	24	3,28

## Princesa

Verre trempé Arcoroc.

EXTRA  
RESISTANT



C .



D .



E . Flûte

Code	Ccl	Φ x Ht cm	Sur.	Prix HT
C . 75 10 605	31	7,4 x 19,7	24	3,48
D . 75 10 606	23	6,7 x 17,4	6	3,28

Code	Ccl	Φ x Ht cm	Sur.	Prix HT
D . 75 10 607	19	6,9 x 16,5	6	3,01
E . 75 10 610	15	5 x 19,6	24	3,01



## Linéal

Jambe haute chic, forme anguleuse et verre trempé : Linéal est la ligne contemporaine des restaurateurs pointilleux. Elle marie l'élégance de leur finesse à leur résistance supérieure.

EXTRA  
RESISTANT



F .



G .

Code	Ccl	Φ x Ht cm	Sur.	Prix HT
F . 75 10 750	31	8,2 x 19,7	24	3,51

Code	Ccl	Φ x Ht cm	Sur.	Prix HT
G . 75 10 751	25	7,7 x 17,4	24	3,28
G . 75 10 752	19	7 x 16,5	24	3,01

Verres à pied

### Tre sensi

TRE SENSI est la deuxième étape du projet In Alto. Développée en étroite collaboration avec l'Association italienne des Sommeliers (AIS), Tre Sensi est une ligne de verres à pied incontournable pour dégustation œnologique : une parfaite transparence du verre et une large paraison pour laisser tous les arômes s'exalter.

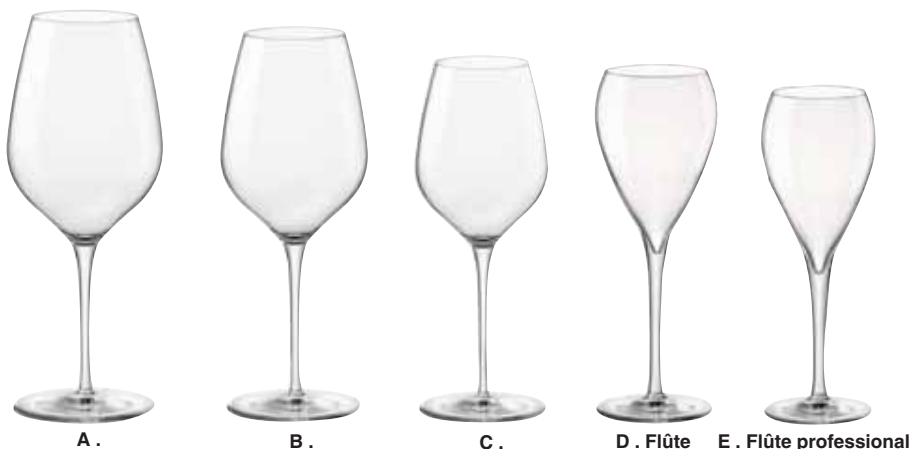

Code	Ccl	Φ x Ht cm	Sur.	Prix HT
A . 75 34 482	55	9,2 x 23,5	24	6,67
B . 75 34 481	43	8,5 x 22	24	5,75
C . 75 34 480	30,5	7,7 x 20,4	24	5,22

Code	Ccl	Φ x Ht cm	Sur.	Prix HT
D . 75 34 433	21,5	5,9 x 20	24	4,14
E . 75 34 430	15	6,9 x 18,5	6	3,36

### Uno chopes

Ses lignes épurées et contemporaines, la transparence et la sonorité du verre, sont de véritables atouts pour votre table.



Code	Ccl	Φ x Ht cm	Sur.	Prix HT
F . 75 34 457	44,5	9,1 x 10,25	24	3,38
G . 75 34 462	35	8,5 x 9,5	24	2,99

F . Gobelet FB G . Gobelet FB

### Aurum

Le style italien s'invite enfin à votre table : laissez le charme agir ! Le design contemporain et géométrique d'Aurum stimule l'oxygénation du vin et la libération des arômes. Une gamme complète de verres à pied en cristallin (brillance, étincellence et sonorité) assortie au gobelet pour une dégustation optimale et un service irréprochable.



### Nexo

L'élégance à l'état pur grâce à son design contemporain. En verre cristallin Star Glass, une jambe étirée et un buvant taillé au laser. Une collection parfaitement étudiée pour un service à table et la dégustation.



Code	Ccl	Φ x Ht cm	Sur.	Prix HT
H . 75 34 400	52	9,3 x 22,5	12	6,03
I . 75 34 401	43	8,9 x 21,3	12	5,47

Code	Ccl	Φ x Ht cm	Sur.	Prix HT
I . 75 34 402	35	8,3 x 20,3	12	5,31
J . 75 34 404	23	6,8 x 23,5	12	5,18
K . 75 34 406	37,5	8,25 x 9,5	12	3,11

Code	Ccl	Φ x Ht cm	Sur.	Prix HT
L . 75 34 636	45	8,8 x 20,9	24	5,18
L . 75 34 635	38	8,3 x 20	24	4,78

## Celebrazione

L'esthétique vintage des verres faits main, enrichis de découpe et d'ornements. Pour une dégustation élégante et raffinée.



A . Flûte



B . Eau & Vin

Code	Ccl	Φ x Ht cm	Sur.	Prix HT
------	-----	-----------	------	---------

A . 75 34 672 21 7,5 x 22,1 12 3,70

Code	Ccl	Φ x Ht cm	Sur.	Prix HT
------	-----	-----------	------	---------

B . 75 34 671 25,5 7,8 x 20,1 12 3,59  
B . 75 34 670 29 8,2 x 20,6 12 3,61



## America'20s

Une ligne de verres à pied (en cristallin) et gobelet inspirés des années 20 qui apporte une note vintage à la table.



C . Gin tonic

D . Cocktail



E . Martini

F . Coupe cocktail



G . FB

Code	Ccl	Φ x Ht cm	Sur.	Prix HT
------	-----	-----------	------	---------

C . 75 34 288 74 10,9 x 22,6 12 7,41  
D . 75 34 290 25 7,8 x 20,2 12 5,13

Code	Ccl	Φ x Ht cm	Sur.	Prix HT
------	-----	-----------	------	---------

E . 75 34 289 25 10,8 x 18 12 6,03  
F . 75 34 287 23 9,8 x 14,7 24 5,18

Code	Ccl	Φ x Ht cm	Sur.	Prix HT
------	-----	-----------	------	---------

G . 75 34 286 38 8,8 x 9,2 36 3,73  
G . 75 34 283 30 8,4 x 8,4 24 3,22

## Florian

Les crêtes douces en forme de pétale sur des tiges richement sculptées. Jambe travaillée à facettes, bord fin coupé au laser.



H . Eau



I . Vin



J . Cocktail



K . Flûte



L . FB

Code	Ccl	Φ x Ht cm	Sur.	Prix HT
------	-----	-----------	------	---------

H . 75 34 643 38 8,2 x 25 24 4,65  
I . 75 34 644 24,5 7,2 x 19,8 24 4,12  
J . 75 34 646 24 9,7 x 16,4 12 4,23

Code	Ccl	Φ x Ht cm	Sur.	Prix HT
------	-----	-----------	------	---------

K . 75 34 645 21 6,5 x 22 24 4,07  
L . 75 34 641 37,5 7,8 x 11,3 24 3,31



## Verres a pied

## Exclusiva

L'effet optique des facettes rend les verres parfaitement brillants. 3 Tailles de carafe.



A . FH



A . FH



B . Carafe



B . Carafe



C . Vin

Code	Ccl	Φ x Ht cm	Sur.	Prix HT
A . 75 34 382	21,5	8,2 x 5,9	12	1,98
A . 75 34 383	35,5	8,5 x 9	12	2,28
A . 75 34 384	50	8,9 x 12	24	2,60

Code	Ccl	Φ x Ht cm	Sur.	Prix HT
B . 75 34 387	25	6,7 x 16,5	12	4,83
B . 75 34 388	50	8,3 x 20,4	6	6,95
B . 75 34 389	100	10,2 x 22,5	6	9,82

Code	Ccl	Φ x Ht cm	Sur.	Prix HT
C . 75 34 386	37,4	6,2 x 20	24	4,83

## Cocktail Glass

Rondeur pour dégustation raffinée, des calices rétro !



D . Meravigliosi

E . Cocktail  
Novecento

F . Nick and Nora

G . Fizz  
Novecento

Code	Ccl	Φ x Ht cm	Sur.	Prix HT
D . 75 36 556	30	10,7 x 14,8	24	4,99
E . 75 34 437	25	9,4 x 15,5	24	4,55

Code	Ccl	Φ x Ht cm	Sur.	Prix HT
F . 75 34 107	15,5	7,4 x 15,5	24	3,70
G . 75 34 438	22	9 x 12,4	24	4,03



## Bartender

Bords minces et jambe courte pour la dégustation de bières.



H .



I .



Code	Ccl	Φ x Ht cm	Sur.	Prix HT
H . 75 34 665	52	8,1 x 23,9	18	5,41
I . 75 34 664	40,5	7,5 x 22,4	24	4,42
I . 75 34 663	28	6,6 x 20,6	24	4,01

## La trempe Bormioli Rocco



Le processus de la trempe consiste à soumettre le verre encore chaud (environ 600°C) à un vrai choc thermique brutal et très rapide (environ 20°C) au moyen d'un jet d'air comprimé sur toute la surface du produit.

Cette étape dans la production confère au produit une extra robustesse aux chocs thermiques et mécaniques.

Le verre trempé présente des caractéristiques intéressantes qui le rendent 2,5 fois plus résistant qu'un verre sodocalcique et dure 10 fois plus longtemps.

En cas de casse, le verre trempé contrairement aux autres verres, se brise en fragments non dangereux.



## Barshine

Concept abouti pour la table et le petit déjeuner. Le verre trempé garantit la sécurité pour les boissons chaudes.



A . Tasse 31,5cl

B . Tasse 25cl

C . Chope FH

D . Chope FB

Code	Ccl	Φ x Ht cm	Sur.	Prix HT
A . 75 34 615	31,5	7,9 x 11,3	12	2,39
B . 75 34 614	25	7,1 x 8	12	2,23
B . 75 34 612	8,9	5,7 x 6,5	12	1,82

Code	Ccl	Φ x Ht cm	Sur.	Prix HT
C . 75 34 623	38	8,3 x 12,1	24	3,22
D . 75 34 622	39,5	9,1 x 10,1	36	2,77
D . 75 34 621	30,5	8,4 x 9,2	36	2,51
D . 75 34 613	21	7,6 x 8,4	24	2,25



## New kalix / Milano

Avec un parfait équilibre des lignes, New Kalix combine le raffinement et l'extra robustesse. Collection complétée avec les trois seules chopes forme boule en verre trempé existant sur le marché.



E . Eau / Vin Milano

F . Flûte

G . Chope boule FH

H . Chope boule FB

Code	Ccl	Φ x Ht cm	Sur.	Prix HT
E . 75 34 200	35	8,4 x 18,9	12	4,82
E . 75 34 201	27	7,8 x 18	12	3,84
F . 75 34 204	17	5,8 x 19,6	12	3,80

Code	Ccl	Φ x Ht cm	Sur.	Prix HT
G . 75 34 208	40	7,5 x 13	12	2,60
H . 75 34 205	38	8,9 x 9,2	12	2,60
H . 75 34 206	30	8,2 x 8,5	12	2,36

## Colosseo

Forte résistance aux chocs mécaniques et thermiques. Verres trempés empilables.



I.

J.

Code	Ccl	Φ x Ht cm	Sur.	Prix HT
I . 75 29 070	28	6,8 x 13,7	24	3,74
J . 75 29 071	22	6,2 x 12,4	24	3,58

## Nonix

Verre trempé empilable



K.

L.

Code	Ccl	Φ x Ht cm	Sur.	Prix HT
K . 75 30 033	58	9 x 15	12	1,96
L . 75 30 032	29	7,4 x 11,5	12	1,42





## Timeless

Indémoudables, les calices Timeless sont des pièces majestueuses, artistiques et solides.



A . Coupe glace



B . Bodega



C . Eau



D . Calice 35



E . Gin Tonic

Code	Ccl	Φ x Ht cm	Sur.	Prix HT
------	-----	-----------	------	---------

Boîte de 2 verres

A . 16 11 582 28 9,8 x 10,3 12 4,96

Boîte de 4 verres

B . 16 13 216 22,5 9 x 5,4 6 8,51

Code	Ccl	Φ x Ht cm	Sur.	Prix HT
------	-----	-----------	------	---------

Boîte de 4 verres

C . 16 13 189 32 8,7 x 15 6 13,46

D . 16 13 192 35 8,75 x 19,6 6 13,74

Code	Ccl	Φ x Ht cm	Sur.	Prix HT
------	-----	-----------	------	---------

Boîte de 4 verres

E . 16 13 193 55 8,5 x 19,8 2 18,92



F . Nick and Nora



G . Martini



H . Coupe



I . Flûte

Code	Ccl	Φ x Ht cm	Sur.	Prix HT
------	-----	-----------	------	---------

Boîte de 4 verres

F . 16 13 224 16 8 x 13,5 6 15,01

G . 16 13 191 23 11,6 x 17,2 6 17,54

Code	Ccl	Φ x Ht cm	Sur.	Prix HT
------	-----	-----------	------	---------

Boîte de 4 verres

H . 16 13 186 27 10,8 x 15,7 4 16,61

I . 16 13 188 17,5 6,4 x 22,5 4 13,40



## Timeless

Trois chopes coniques viennent compléter la gamme avec la contenance 36cl droite tube.



A . FH Conique



B . FH Conique



C . FB Conique



D . FB



E . FB



F . FB

Code	Ccl	Φ x Ht cm	Sur.	Prix HT
------	-----	-----------	------	---------

Boîte de 4 verres

A . 16 13 228	47	6,8 x 14,3	6	16,16
B . 16 13 227	36	6 x 14,7	6	13,28

Code	Ccl	Φ x Ht cm	Sur.	Prix HT
------	-----	-----------	------	---------

Boîte de 4 verres

C . 16 13 226	35	7,3 x 9,7	6	13,63
D . 16 13 223	34,5	8,6 x 9,6	6	11,56

Code	Ccl	Φ x Ht cm	Sur.	Prix HT
------	-----	-----------	------	---------

Boîte de 4 verres

E . 16 13 215	21	7,4 x 8,3	6	8,51
F . 16 13 214	6	4,8 x 6,2	12	6,21



G . FH Tube 36



H . FH



I . FH

Code	Ccl	Φ x Ht cm	Sur.	Prix HT
------	-----	-----------	------	---------

Boîte de 4 verres

G . 16 13 225	36,5	7,2 x 15,3	6	10,52
H . 16 13 218	45	7,8 x 16,1	6	13,00

Code	Ccl	Φ x Ht cm	Sur.	Prix HT
------	-----	-----------	------	---------

Boîte de 4 verres

I . 16 13 217	30	6,8 x 14,3	6	10,70
---------------	----	------------	---	-------



J . Broc



K . Mixing

Code	Ccl	Φ x Ht cm	Sur.	Prix HT
------	-----	-----------	------	---------

J . 75 41 313	140	10,6 x 21,7	6	12,42
---------------	-----	-------------	---	-------

Code	Ccl	Φ x Ht cm	Sur.	Prix HT
------	-----	-----------	------	---------

K . 75 41 318	72	10,5 x 14,5	6	7,19
---------------	----	-------------	---	------

# ELYSIA

Collection by Pasabahce



Parfait pour servir des spiritueux



## Estrella

Facettée, un diamant taillé dans la base du verre.



### La mixology

Certains designs sont intemporels, ils traversent les âges en restant toujours d'actualité.

Devenu un classique de la Mixology, Timeless donne aussi un caractère au service de table.

Solide en verre mécanique, la gamme est désormais complète pour toutes les occasions.

Avec les mêmes qualités que Timeless, Elysia est intentionnellement glamour.

La seule présence d'Elysia sur la table donnera des paillettes à votre événement.



Code	Ccl	Φ x Ht cm	Sur.	Prix HT
A . 75 41 553	34	8,7 x 19,5	4	2,65
B . 75 41 552	49	10 x 19,8	12	4,03

Code	Ccl	Φ x Ht cm	Sur.	Prix HT
C . 75 41 554	21	11,6 x 17,2	4	3,51
D . 75 41 555	25	11 x 15,7	4	3,38



## Elysia

Majestueuses et inclassables, High Society. Verre mécanique très solide.



Code	Ccl	Φ x Ht cm	Sur.	Prix HT
Boîte de 4 verres				
E . 16 13 084	6	4,5 x 6,6	4	9,66
F . 16 13 086	21	7,3 x 8,5	6	8,96
G . 16 13 087	36	8,4 x 9,8	6	11,96

Code	Ccl	Φ x Ht cm	Sur.	Prix HT
Boîte de 4 verres				
H . 16 13 088	28	6,5 x 14	6	10,80
I . 16 13 081	45	7,6 x 15	6	13,36



Code	Ccl	Φ x Ht cm	Sur.	Prix HT
Boîte de 4 verres				
J . 16 13 083	22	11,6 x 17,2	6	18,34

Code	Ccl	Φ x Ht cm	Sur.	Prix HT
Boîte de 4 verres				
K . 16 13 085	26	10,1 x 16,4	6	16,80
L . 16 13 082	50	10,1 x 19,8	6	19,80

## Verres à pied

### Joy

Design rétro mais contemporain, une collection dynamique et élégante. Verre mécanique.



A . Gin tonic



B . Cocktail



C . Coupe



D . Flûte



E . Cognac



F . Chope FH

Code	Ccl	Φ x Ht cm	Sur.	Prix HT
------	-----	-----------	------	---------

Boîte de 4 verres

A . 16 13 380	50	10,5 x 21	2	16,75
B . 16 13 382	22	11,8 x 16	2	15,40

Code	Ccl	Φ x Ht cm	Sur.	Prix HT
------	-----	-----------	------	---------

Boîte de 4 verres

C . 16 13 381	25	12,1 x 14,7	2	14,40
D . 16 13 383	17,5	6,7 x 22	6	13,05

Code	Ccl	Φ x Ht cm	Sur.	Prix HT
------	-----	-----------	------	---------

Boîte de 4 verres

E . 16 13 379	26	8,5 x 12,9	6	11,95
F . 16 13 378	36	8,4 x 13,1	6	12,20

### Amber et Essence

6 calices définis pour chaque utilité. Verre mécanique solide pied plaqué.



G . Bourgogne



H . Bordeaux



I . Risis



J . Bière



K . Flûte



L . Chope



M . Montecarlo

Code	Ccl	Φ x Ht cm	Sur.	Prix HT
------	-----	-----------	------	---------

G . 16 13 063	47,5	10 x 21,5	6	1,98
H . 16 13 062	46	9 x 22	6	1,85
I . 16 13 061	45,5	10 x 19,5	6	1,74

Code	Ccl	Φ x Ht cm	Sur.	Prix HT
------	-----	-----------	------	---------

J . 16 13 060	40,5	8 x 18	6	1,83
K . 16 13 064	19	6,5 x 22,5	6	1,35

Code	Ccl	Φ x Ht cm	Sur.	Prix HT
------	-----	-----------	------	---------

L . 16 13 065	35	8 x 10	6	1,46
M . 75 41 222	39	7,8 x 11	24	1,90



### Tulip

Tradition et robustesse d'une série toujours d'actualité. Trois chopes cocktails complètent la gamme.



N .



O .



P . Flûte



Q . Cocktail Capri

Code	Ccl	Φ x Ht cm	Sur.	Prix HT
------	-----	-----------	------	---------

N . 75 41 281	31	7,6 x 17	24	1,44
O . 75 41 282	24	7,1 x 16,5	24	1,38
O . 75 41 283	20	6,5 x 15,5	24	1,09

Code	Ccl	Φ x Ht cm	Sur.	Prix HT
------	-----	-----------	------	---------

P . 75 41 285	20	6,5 x 20,5	24	1,50
Q . 75 41 120	38,5	7,4 x 17,6	24	2,45

## Savage

Inspirée par le célèbre mixologue, SIMPLE est beau, pur, clair et transparent. Verre cristallin.



A . Coupe



B . Coupe



C . Pony



D . FH



E . FB



E . FB



E . FB

Code	Ccl	Φ x Ht cm	Sur.	Prix HT
A . 75 41 593	22	10,8 x 17,5	24	5,02
B . 75 41 592	17	10 x 16,7	6	4,62
C . 75 41 589	13,5	7,2 x 16,5	6	3,96

Code	Ccl	Φ x Ht cm	Sur.	Prix HT
D . 75 41 588	33	6,7 x 14,5	24	3,72
E . 75 41 587	29	8,5 x 7,5	24	3,61

## Caldéra



Ligne épurée avec des motifs en V distinctifs. Verre cristallin.

Code	Ccl	Φ x Ht cm	Sur.	Prix HT
D . 75 41 574	32,5	8,9 x 9,1	24	xxx
E . 75 41 573	28,5	6,9 x 15,1	24	xxx



## Finesse

SIMPLE est utilisable, propre, épuré, délicat, au féminin comme au masculin.



F . FH



G . FB

Code	Ccl	Φ x Ht cm	Sur.	Prix HT
F . 75 41 580	35	6 x 14	6	2,73
G . 75 41 581	39	8 x 9	6	2,46
G . 75 41 579	30	7,5 x 8	6	2,20

J .  
Water  
Savage



K .  
Pure



Code	Ccl	Φ x Ht cm	Sur.	Prix HT
J . 75 41 595	26	8 x 8	6	3,61
K . 75 41 583	25	7,5 x 9,5	6	2,88



Verres à pied

### Allegra Focus

La courbure moderne à la cassure parfaite.  
Verre mécanique solide.



Code	Ccl	Φ x Ht cm	Sur.	Prix HT
A . 75 41 631	49	9,1 x 21,8	24	3,19
B . 75 41 630	35	7,5 x 21,7	6	2,98

Code	Ccl	Φ x Ht cm	Sur.	Prix HT
C . 75 41 632	42	8,9 x 10,9	24	2,13

### Allegra

La courbure moderne à la cassure parfaite. Verre mécanique solide.

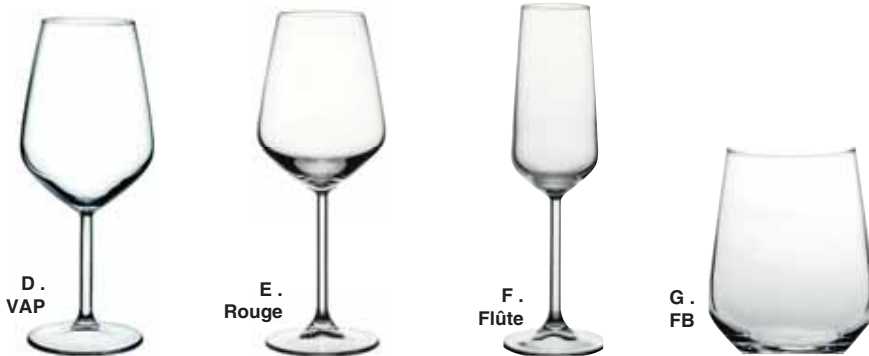

Code	Ccl	Φ x Ht cm	Sur.	Prix HT
D . 75 41 616	49	9,1 x 21,8	6	2,53
E . 75 41 618	35	7,3 x 21,7	6	2,46

Code	Ccl	Φ x Ht cm	Sur.	Prix HT
F . 75 41 619	19,5	7 x 22,6	6	2,53
G . 75 41 615	42,5	8,9 x 10,9	24	1,76

### Ambassador



Grands volumes pour les amoureux de la rondeur.  
Verre mécanique solide.



Code	Ccl	Φ x Ht cm	Sur.	Prix HT
H . 75 41 260	55	9,8 x 21,4	6	2,55

### Tower - Nonic



Verres empilables trempé.

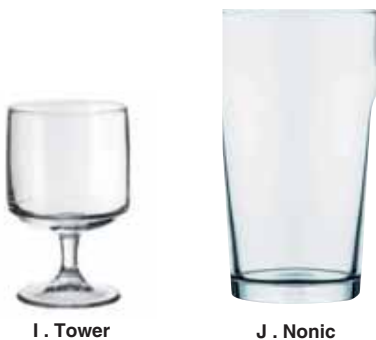

Code	Ccl	Φ x Ht cm	Sur.	Prix HT
I . 75 41 092	22	7 x 11,2	12	1,45
J . 75 41 180	56	8,5 x 15	24	1,44

### Tester

Verre mécanique.



Code	Ccl	Φ x Ht cm	Sur.	Prix HT
K . 75 41 115	21,5	7 x 15,5	12	1,44

### Enotéca



Deux formes de verres raffinés, fins, aux grands volumes pour la dégustation de grands vins.



Code	Ccl	Φ x Ht cm	Sur.	Prix HT
L . 75 41 251	65,5	8,5 x 21,6	24	3,85
M . 75 41 250	55	8,2 x 23,2	24	3,39

New products  
Nouveautés

**Comptoir**

Verre unique raffiné et solide



A.

Code	Ccl	Φ x Ht cm	Sur.	Prix HT
------	-----	-----------	------	---------

Lot de 6 verres				
A . 16 13 027	31	5,9 x 13,2	6	6,45

**Ivory**

Convexe, court et solide.



B.



C.



D.

Code	Ccl	Φ x Ht cm	Sur.	Prix HT
------	-----	-----------	------	---------

Lot de 3 verres				
B . 16 18 596	49	9,7 x 23	24	5,43
C . 16 18 595	33,5	8,6 x 20,5	18	5,04

Code	Ccl	Φ x Ht cm	Sur.	Prix HT
------	-----	-----------	------	---------

Lot de 3 verres				
D . 16 18 597	22,5	6,9 x 22,6	12	5,04

**Impérial**

Verre mécanique renforcé pied plaqué, buvant trempé.



E.



F.



G . Flûte (lot de 3)



H . Chope FB

Code	Ccl	Φ x Ht cm	Sur.	Prix HT
------	-----	-----------	------	---------

E . 75 41 072	34	7 x 18	24	1,75
F . 75 41 073	25	6,2 x 16,9	48	1,45
F . 75 41 074	20	6 x 16	24	1,40

Code	Ccl	Φ x Ht cm	Sur.	Prix HT
------	-----	-----------	------	---------

G . 16 13 630	21	6,4 x 21,5	8	4,85
H . 75 41 077	31	7,8 x 8,7	48	1,55

**Bistro / Paris**

Classique équilibré, son pied plaqué et sa taille basse en font un verre adapté à toutes les tables.

I . Vin  
EauJ . Flûte  
(lot de 3)

Code	Ccl	Φ x Ht cm	Sur.	Prix HT
------	-----	-----------	------	---------

I . 75 41 065	26	8,2 x 16	24	1,44
I . 75 41 066	21	7,6 x 14,7	24	1,14
J . 16 13 630	21	6,4 x 21,5	8	4,85

**Banquet**

Verre mécanique



K . VAP

Code	Ccl	Φ x Ht cm	Sur.	Prix HT
------	-----	-----------	------	---------

K . 75 41 033	19	8 x 14,8	12	1,14
Lot de 10 verres				
K . 16 13 041	19	8 x 14,8	1	9,72

## Verres à pied

## Novastyl

novastyl

Découvrez une gamme exceptionnelle de verrerie alliant savoir-faire traditionnel et techniques modernes.

Notre collection inclut différents verres cristallin, gobelets et chopes à bière tous conçus pour des occasions spécifiques.

Nos produits, durables et de haute qualité, embellissent votre table et répondent aux besoins des professionnels et particuliers.

Chaque pièce est une œuvre d'art prête à illuminer vos moments précieux.

## Inao

Verre cristallin sophistiqué.



A.

Code	Ccl	Φ x Ht cm	Sur.	Prix HT
------	-----	-----------	------	---------

Boîte de 6 verres

A . 19 71 885	21	6,5 x 16	8	12,05
---------------	----	----------	---	-------

## Pied vert

Verre cristallin sophistiqué.

novastyl



B.

Code	Ccl	Φ x Ht cm	Sur.	Prix HT
------	-----	-----------	------	---------

Lot de 3 verres

B . 19 71 890	16,5	6,5 x 16	6	10,50
---------------	------	----------	---	-------

## Rondo

Empilable et solide



C.

## Tower

Verre trempé empilable



D.

Code	Ccl	Φ x Ht cm	Sur.	Prix HT
------	-----	-----------	------	---------

Lot de 3 verres

C . 16 18 070	21	7,5 x 9	6	3,50
---------------	----	---------	---	------

C . 16 18 152	25	8 x 10	6	3,75
---------------	----	--------	---	------

Lot de 4 verres

D . 16 13 310	22	7 x 11,2	4	6,04
---------------	----	----------	---	------

## Matignon

Verre cristallin sophistiqué.

novastyl



E.



F.



G . Flûte

Code	Ccl	Φ x Ht cm	Sur.	Prix HT
------	-----	-----------	------	---------

Lot de 3 verres

E . 19 71 816	23	7 x 16	16	6,44
---------------	----	--------	----	------

F . 19 71 815	19	7 x 15,2	16	6,44
---------------	----	----------	----	------

Lot de 3 verres

G . 19 71 817	18	5,3 x 17,5	16	6,44
---------------	----	------------	----	------



novastyl

## Glen

Verre mécanique solide.



H . FH



I . FB

Code	Ccl	Φ x Ht cm	Sur.	Prix HT
------	-----	-----------	------	---------

Lot de 6 verres

H . 16 18 291	35,5	7 x 14,5	6	15,00
---------------	------	----------	---	-------

I . 16 18 290	33	8,4 x 9	6	13,50
---------------	----	---------	---	-------

## Sand

Rondeur et volume en verre solide mécanique



J . Gobelet



K . Gobelet

Code	Ccl	Φ x Ht cm	Sur.	Prix HT
------	-----	-----------	------	---------

Boîte de 4 verres

J . 16 18 331	40,5	9,3 x 9,4	6	6,30
---------------	------	-----------	---	------

K . 16 18 332	51	7,6 x 14,5	6	6,70
---------------	----	------------	---	------

## Bonita

Multi-usage en verre solide mécanique



L . Gobelet



M . Gobelet

Code	Ccl	Φ x Ht cm	Sur.	Prix HT
------	-----	-----------	------	---------

Boîte de 4 verres

L . 16 18 333	24	8,2 x 5,8	6	4,55
---------------	----	-----------	---	------

M . 16 18 334	34,5	8,4 x 8,8	6	5,15
---------------	------	-----------	---	------

Verres à pied



**Noa**

Verre mécanique solide



Code	Ccl	Φ x Ht cm	Sur.	Prix HT
Lot de 3 verres				
A . 16 18 832	44	9,5 x 21,5	8	6,90
B . 16 18 833	33	8,5 x 20,5	8	5,92

Code	Ccl	Φ x Ht cm	Sur.	Prix HT
Lot de 3 verres				
C . 16 18 834	23	6 x 22,5	8	5,92



**Florence**

Design élané en verre mécanique solide



Code	Ccl	Φ x Ht cm	Sur.	Prix HT
Lot de 3 verres				
D . 16 18 375	33	8,2 x 20,6	6	5,74
E . 16 18 376	29,5	7,5 x 19,2	8	5,50

Code	Ccl	Φ x Ht cm	Sur.	Prix HT
Lot de 3 verres				
F . 16 18 377	23	6,4 x 22,5	8	5,50
G . 16 18 371	34	8,6 x 8,5	8	4,28

**Cognac**

Verre mécanique

**Cocktail**

Verre mécanique

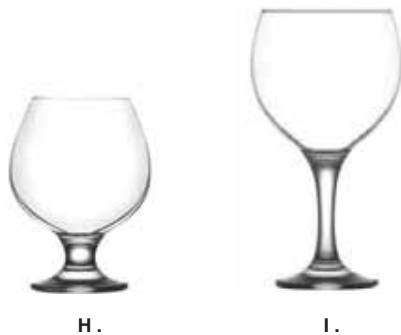

Code	Ccl	Φ x Ht cm	Sur.	Prix HT
H . 16 13 430	39	9 x 12,5	24	1,55
Lot de 2 verres				
I . 16 18 257	64,5	11 x 20,4	12	4,38

**Belek**

Pinte en verre mécanique



Code	Ccl	Φ x Ht cm	Sur.	Prix HT
J . 16 18 396	58	8 x 16	12	1,85
Lot de 3 verres				
K . 16 11 480	40	7,2 x 20,5	6	5,79

**Brasseur**

Verre mécanique

**Tulipe**

Verre mécanique



Code	Ccl	Φ x Ht cm	Sur.	Prix HT
L . 16 13 425	38	7,2 x 19	24	2,25



## Verres à pied

## Riviera bleu

Laver à la main uniquement



A.



B.



C.



D.

Code	Ccl	Φ x Ht cm	Sur.	Prix HT
------	-----	-----------	------	---------

Boîte de 4 verres

E . 16 05 446	49	9,5 x 20,2	4	12,60
F . 16 05 447	36,5	10,5 x 16,2	4	13,25

Code	Ccl	Φ x Ht cm	Sur.	Prix HT
------	-----	-----------	------	---------

Boîte de 4 verres

G . 16 05 445	24	7 x 24	6	12,60
H . 16 05 448	52,5	9 x 10,5	6	9,15



## Riviera vert

Laver à la main uniquement



E.



F.



G.



H.

Code	Ccl	Φ x Ht cm	Sur.	Prix HT
------	-----	-----------	------	---------

Boîte de 4 verres

E . 16 05 436	49	9,5 x 20,2	4	12,60
F . 16 05 437	36,5	10,5 x 16,2	4	13,25

Code	Ccl	Φ x Ht cm	Sur.	Prix HT
------	-----	-----------	------	---------

Boîte de 4 verres

G . 16 05 435	24	7 x 24	6	12,60
H . 16 05 438	52,5	9 x 10,5	6	9,15

## Riviera Orange

Laver à la main uniquement



I.



J.



K.



L.

Code	Ccl	Φ x Ht cm	Sur.	Prix HT
------	-----	-----------	------	---------

Boîte de 4 verres

I . 16 05 441	49	9,5 x 20,2	4	12,60
J . 16 05 442	36,5	10,5 x 16,2	4	13,25

Code	Ccl	Φ x Ht cm	Sur.	Prix HT
------	-----	-----------	------	---------

Boîte de 4 verres

K . 16 05 440	24	7 x 24	6	12,60
L . 16 05 443	52,5	9 x 10,5	6	9,15



**Eden**

Laver à la main uniquement



A.



B.



C.



D.

Code	Ccl	Φ x Ht cm	Sur.	Prix HT
------	-----	-----------	------	---------

Boîte de 4 verres

A . 16 05 462	48	11,6 x 24	4	22,50
B . 16 05 461	36	10,5 x 22,5	4	21,90

Code	Ccl	Φ x Ht cm	Sur.	Prix HT
------	-----	-----------	------	---------

Boîte de 4 verres

C . 16 05 460	17	7,5 x 26	4	20,60
D . 16 05 463	35,5	9,8 x 11	4	16,90

**Gatsby**

Laver à la main uniquement



E.



F.



G.

Code	Ccl	Φ x Ht cm	Sur.	Prix HT
------	-----	-----------	------	---------

Boîte de 4 verres

E . 16 05 450	57	9,5 x 25,4	4	17,20
F . 16 05 451	31	11 x 18,4	4	17,20

Code	Ccl	Φ x Ht cm	Sur.	Prix HT
------	-----	-----------	------	---------

Boîte de 4 verres

G . 16 05 452	59	9,5 x 12	4	14,40
---------------	----	----------	---	-------

**Léopard**

Laver à la main uniquement



H.



I.



J.



K.

Code	Ccl	Φ x Ht cm	Sur.	Prix HT
------	-----	-----------	------	---------

Boîte de 4 verres

H . 16 05 457	43	9 x 22	4	18,10
I . 16 05 456	27	11,5 x 18,5	4	19,40

Code	Ccl	Φ x Ht cm	Sur.	Prix HT
------	-----	-----------	------	---------

Boîte de 4 verres

J . 16 05 455	18	7 x 26,3	4	16,25
K . 16 05 458	52	9,5 x 12	4	13,70

Verres a pied

**Roma**

Calice résistant pour des usages intensifs. Verre mécanique.

**oris**



A.



B.



C.



D.

Code	Ccl	Φ x Ht cm	Sur.	Prix HT
A . 75 42 344	34	8,1 x 18,4	6	2,20
B . 75 42 345	24	7,5 x 17	6	2,12

Code	Ccl	Φ x Ht cm	Sur.	Prix HT
C . 75 42 346	20	6,9 x 15,4	6	2,12
D . 75 42 347	19	6,3 x 19,8	6	2,28



**L'esprit du vin**

Verre non trempé.

**oris**

**Perfection**

Verre Xtratuff pied plaqué.

**XTRATUFF**

**Aristo carré**

Verre non trempé.

**oris**



E.  
Eau



F.  
Flûte



G.  
FB



H.



I.



J.  
Rouge



K.  
Blanc



L.  
Flûte

Code	Ccl	Φ x Ht cm	Sur.	Prix HT
E . 75 42 072	32	7,7 x 19,8	6	3,19
E . 75 42 073	25	7,1 x 19	6	2,98
F . 75 42 074	21	6,3 x 21,4	6	3,06
G . 75 42 075	33	8,5 x 9,9	6	2,92

Code	Ccl	Φ x Ht cm	Sur.	Prix HT
H . 75 42 055	n° 1-41	8,6 x 20,8	12	4,69
I . 75 42 056	n° 0-32	7,9 x 19,8	12	4,55

Code	Ccl	Φ x Ht cm	Sur.	Prix HT
J . 75 42 120	38	8,3 x 21,7	6	3,54
K . 75 42 121	29	7,6 x 20,7	6	3,54
L . 75 42 122	22	6,9 x 22,8	6	3,54



**SPKSY**

Le goût de la prohibition réinventée.

**oris**



M . Gin & T



N . Martini



O . Nick & Nora



P . Calice

Code	Ccl	Φ x Ht cm	Sur.	Prix HT
M . 75 42 036	58	10,3 x 20,3	12	5,31
N . 75 42 038	19,3	9,9 x 16,4	12	5,85

Code	Ccl	Φ x Ht cm	Sur.	Prix HT
O . 75 42 032	24,5	7,9 x 16	12	5,31
P . 75 42 037	24,5	9,65 x 15,23	12	5,31

## Anchor

XTRATUFF

Verre Xtratuff «Double old fashioned»  
Parfait pour les shortdrinks et spiritueux en glace.



A . FH



B . FB

Code	Ccl	Φ x Ht cm	Sur.	Prix HT
A . 75 42 271	47	8,5 x 15,7	12	5,46
B . 75 42 270	35,5	8,8 x 10,5	12	4,99

## Pentagon

XTRATUFF

Cinq facettes à la base, buvant arrondi.  
Verre Xtratuff.



C . FH



D . FB

Code	Ccl	Φ x Ht cm	Sur.	Prix HT
C . 75 42 184	35	8,1 x 14,3	12	3,96
C . 75 42 185	29	7,7 x 13,8	12	3,34
D . 75 42 187	35	9,6 x 10	12	3,64
D . 75 42 189	26	8,6 x 9	12	3,56

## ICON

oris

Résistants et solides.



E . FH



F . FB



G .

Code	Ccl	Φ x Ht cm	Sur.	Prix HT
E . 75 42 241	47	8,4 x 15,7	12	5,63
F . 75 42 242	35	8,9 x 10,7	12	5,03
G . 75 42 240	6	5 x 6,1	24	3,86

## Adventure

XTRATUFF

Parfaitement empilable pour  
mettre en pyramide.



H . FB



H . FB

Code	Ccl	Φ x Ht cm	Sur.	Prix HT
H . 75 42 171	35	9,8 x 10,5	12	2,52
H . 75 42 172	26	8,9 x 9,8	12	2,07
H . 75 42 173	20	8,3 x 9,2	12	2,20

## Facets

XTRATUFF

Verre à xxx solides



I . FH



J . FB

Code	Ccl	Φ x Ht cm	U.V	Prix HT
I . 75 42 201	47	8,4 x 15,3	36	2,75
I . 75 42 202	35	7,9 x 13,7	36	2,50
J . 75 42 203	26	7,5 x 10,3	36	2,33

## Hampshire

XTRATUFF

Retour des produits d'antan baroques.  
Verre Xtratuff



K .



L .

Code	Ccl	Φ x Ht cm	Sur.	Prix HT
K . 75 42 209	37	7,7 x 13,6	12	2,92
L . 75 42 204	29	8,32 x 9	36	2,51
L . 75 42 205	23	7,9 x 8,5	36	2,34



M . FH



M . FH



Code	Ccl	Φ x Ht cm	Sur.	Prix HT
M . 75 42 168	47	8,3 x 17,8	12	3,32
M . 75 42 169	35	7,6 x 15,9	12	3,17
M . 75 42 170	29	7 x 15,9	12	3,06



## Tarq

XTRATUFF

Sophistiqué, raffiné, empilable.



N . FH



O . FB

Code	Ccl	Φ x Ht cm	Sur.	Prix HT
N . 75 42 296	34,5	7,9 x 12,7	12	2,46
O . 75 42 297	35	8,8 x 9,7	12	2,46
O . 75 42 298	26	8,1 x 8,7	12	2,46

Verres à pied

Cognac - Spirits



A . XXL



B . Mondial

Code	Ccl	Φ x Ht cm	Sur.	Prix HT
A . 75 43 055 88		11,2 x 16,3	6	6,25
B . 75 43 344 51,1		10,1 x 14,7	6	3,58



C . Snifter



D . Rêverie

Code	Ccl	Φ x Ht cm	Sur.	Prix HT
C . 75 34 491 53		9,9 x 14,9	24	3,73
D . 16 13 430 39		9 x 12,5	24	1,55



E . Mixology



F . Joy

Code	Ccl	Φ x Ht cm	Sur.	Prix HT
E . 75 36 255 46		9,7 X 12,7	12	5,72
F . 16 13 379 26		8,5 X 12,9	6	11,95

Boîte de 4 verres



G . Arc



H . Arc

Code	Ccl	Φ x Ht cm	Sur.	Prix HT
G . 75 11 002 41		9,5 x 12,9	24	4,38
H . 75 11 003 25		8,2 x 11,2	24	3,51



I . Arc



J . Open Up

Code	Ccl	Φ x Ht cm	Sur.	Prix HT
I . 75 11 005 15		6,7 x 9,6	72	3,12
J . 75 06 420 38		9,3 x 9,4	24	3,27



K . Rhum



L . Warm

Code	Ccl	Φ x Ht cm	Sur.	Prix HT
K . 75 11 500 17		7,5 x 12,7	24	4,04
L . 75 06 423 29		9,9 x 8,6	24	5,97

Irish coffee



M . Sentido



N .

Code	Ccl	Φ x Ht cm	Sur.	Prix HT
M . 16 31 115 26		11,1 x 14,2	6	3,46
N . 75 10 550 24		7,6 x 13,9	24	5,52

Old is new



O . Nick & Nora Rocco



P . Nick & Nora Mixology

Code	Ccl	Φ x Ht cm	Sur.	Prix HT
O . 75 34 107 15,5		7,4 x 15,5	24	3,70
P . 75 36 247 15		6,9 x 14,7	24	3,59



Q . Nick & Nora Timeless



R . Pied vert (lot de 3)

Code	Ccl	Φ x Ht cm	Sur.	Prix HT
Q . 16 13 224 16		8 x 13,5	6	3,97
R . 19 71 890 16,5		6,5 x 16	6	10,50

Boîte de 4 verres

Lot de 3 verres

Bière chopes



S . Brasseur (lot de 3)



T . Weizen (Pièce)

Code	Ccl	Φ x Ht cm	Sur.	Prix HT
S . 16 11 480 40		6,9 x 19,9	6	5,79
T . 75 41 132 69		8 x 23,3	12	2,47

Lot de 3 verres

Pièce



U . Belek (Pièce)



V . Bière (lot de 2)

Code	Ccl	Φ x Ht cm	Sur.	Prix HT
U . 16 18 396 58		8 x 16	12	1,85
V . 16 18 397 33		7 x 16,5	12	3,45

Lot de 2 verres



W . Martigues



X . Martigues

Code	Ccl	Φ x Ht cm	Sur.	Prix HT
W . 75 06 310 16		6,9 x 15	24	2,15
X . 75 06 017 33		8 x 17,9	6	2,56

### Wells



A

B

Code	Ccl	Φ x Ht cm	Sur.	Prix HT
A . 75 11 228	28	7 x 16	24	3,54
B . 75 11 229	38	7,5 x 17	24	3,75
B . 75 11 230	42,5	7,5 x 18	24	4,20
B . 75 11 231	57	8,5 x 19	24	4,20



### Joly



C

D

Code	Ccl	Φ x Ht cm	Sur.	Prix HT
C . 75 12 153	35	9,2 x 12,5	24	4,01
D . 75 12 154	45	9,7 x 13,8	24	4,69



E . Hurricane

F . Fiesta

G . Essence

H . Cerveoise

I . Cerveoise

Code	Ccl	Φ x Ht cm	Sur.	Prix HT
E . 75 10 059	44	7,9 x 20,7	24	6,59
F . 16 18 319	46	8 x 19,5	12	2,19
G . 16 13 060	40,5	8 x 18	6	1,83

Code	Ccl	Φ x Ht cm	Sur.	Prix HT
H . 75 10 620	32	7,2 x 16,8	24	3,54
I . 75 08 027	38	7,6 x 17,8	24	3,75
I . 75 10 621	50	8,3 x 19,2	24	4,20



J . Capri

K . Tulip

Code	Ccl	Φ x Ht cm	Sur.	Prix HT
J . 75 41 120	38,5	7,3 x 17,6	24	2,45
K . 16 13 425	38	7 x 19	24	2,25



L . Draft

M . Linz

Code	Ccl	Φ x Ht cm	Sur.	Prix HT
L . 75 41 942	38	7,1 x 18,8	24	2,13
M . 75 06 134	39	6,9 x 20,6	24	3,01



N . Bartender

O . Bartender

Code	Ccl	Φ x Ht cm	Sur.	Prix HT
N . 75 34 665	52	8,1 x 23,9	18	5,41
O . 75 34 664	40,5	7,5 x 22,4	24	4,42
O . 75 34 663	28	6,6 x 20,6	24	4,01

### Bocks



P . Britannia

Q . Basic

Code	Ccl	Φ x Ht cm	Sur.	Prix HT
P . 75 08 008	28	8,2 x 9,6	36	2,81
P . 75 08 009	56	9,9 x 12,4	24	3,51
Q . 75 41 105	35	12,5 x 9,8	24	2,36



R . Latino

S . Chope

Code	Ccl	Φ x Ht cm	Sur.	Prix HT
R . 75 08 100	29	9,9 x 15	24	4,17
S . 75 41 055	50	8,5 x 13,6	24	3,40
S . 75 41 056	39,5	7,7 x 13,5	12	3,11



T . Brasseur (lot de 2)

U . Haworth

Code	Ccl	Φ x Ht cm	Sur.	Prix HT
T . 16 05 383	54	10 x 12,5	6	4,03
U . 75 08 010	57	9,3 x 13,1	24	3,51
U . 75 08 011	28	7,1 x 10,3	36	2,81

Coupe - Cocktail

Calices



ARCOROC



A . Disco



B . Disco



C . Elégance



D . Symétrie



E . Coupe  
Champagne Cabernet



F . Speakeasy  
Swing



G . Meravigliosi

Code	Ccl	Φ x Ht cm	Sur.	Prix HT
A . 75 11 347	21	9 x 16	24	3,77
B . 75 11 346	18	7,5 x 17	12	3,77
C . 75 11 270	16	9 x 12,2	48	3,21

Code	Ccl	Φ x Ht cm	Sur.	Prix HT
D . 75 11 294	21	11,4 x 18	24	5,54
E . 75 10 437	30	12 x 16,5	12	5,04

Code	Ccl	Φ x Ht cm	Sur.	Prix HT
F . 75 36 564	30	10,7 x 14,8	24	7,98
G . 75 36 556	30	10,7 x 14,8	24	4,99



H . Michelangelo



I . Mixology



J . Cocktail Roma



K . Fizz



L . Novecento  
Cocktail



M . America

Code	Ccl	Φ x Ht cm	Sur.	Prix HT
H . 75 36 015	22	9,5 x 14	24	4,20
I . 75 36 249	22,5	9,5 x 14	24	4,39

Code	Ccl	Φ x Ht cm	Sur.	Prix HT
J . 75 36 257	30	11,3 x 15	12	6,00
K . 75 36 477	26	9,7 x 15,7	16	5,42

Code	Ccl	Φ x Ht cm	Sur.	Prix HT
L . 75 34 437	25	9,4 x 15,5	24	4,55
M . 75 34 287	23	9,8 x 14,7	24	5,18



Margarita



N . Joy



O . Coupe



P . Coupe



Q . Margarita  
Roma



R . Margarita  
Capri 30



S . Margarita  
non trempé

Code	Ccl	Φ x Ht cm	Sur.	Prix HT
Boîte de 4 verres				
N . 16 13 381	25	12,1 x 14,7	2	14,40
O . 16 13 186	27	10,8 x 15,7	12	16,61
P . 16 13 085	26	10,1 x 16,4	12	16,80

Code	Ccl	Φ x Ht cm	Sur.	Prix HT
Q . 75 36 261	39	11,4 x 18,4	12	6,23

Code	Ccl	Φ x Ht cm	Sur.	Prix HT
R . 75 41 948	30,5	11,5 x 16,9	12	2,24
S . 75 10 074	27	10,8 x 16	24	6,58

Martini cocktail

Brio

ARCOROC



A . Cabernet cocktail



B . New Martini



C . Brio



D . Brio



E . Brio

Code	Ccl	Φ x Ht cm	Sur.	Prix HT
A . 75 10 413	30	12 x 18,8	12	5,04
A . 75 10 346	30	11,6 x 17,2	12	5,04
B . 75 10 347	21	11,4 x 17,9	24	5,04

Code	Ccl	Φ x Ht cm	Sur.	Prix HT
C . 75 10 902	21	8,3 x 19,2	12	3,35
D . 75 10 901	16	6,9 x 22,4	24	3,35
E . 75 10 900	9,5	5,6 x 17,1	24	2,97



F . Martini Mixology



G . Roma Martini



H . Bach



I . Ypsilon



J . America 20s



K . Martini Chiller

Code	Ccl	Φ x Ht cm	Sur.	Prix HT
G . 75 36 248	21,5	10,4 x 17,2	24	5,38
H . 75 36 260	22	10,4 x 17,2	24	5,62

Code	Ccl	Φ x Ht cm	Sur.	Prix HT
K . 75 34 084	24,5	11,2 x 18,2	6	7,14
J . 75 36 473	26	11,3 x 18,5	16	6,56

Code	Ccl	Φ x Ht cm	Sur.	Prix HT
N . 75 34 289	25	10,8 x 18	12	6,03
I . 75 42 050	17	11,1 x 8,9	6	7,53



L . Martini Estrella



M . Martini



O . Joy



P . Martini Elysia



Q . Martini Timeless

Code	Ccl	Φ x Ht cm	Sur.	Prix HT
L . 75 41 554	21	11,6 x 17,2	4	3,51
M . 75 41 859	19	10,7 x 13,6	12	1,75

Code	Ccl	Φ x Ht cm	Sur.	Prix HT
O . 16 13 382	22	11,8 x 16	2	15,40

Boîte de 4 verres

Code	Ccl	Φ x Ht cm	Sur.	Prix HT
P . 16 13 083	22	11,6 x 17,2	6	18,34
Q . 16 13 191	23	11,6 x 17,2	12	17,54

Boîte de 4 verres

Flûtes et coupes

Flûtes point mousse



A . Tre sensi



B . Dream



C . Michelangelo



D . Allegra



E . Ivory



F . Florian



G . Celebrazion

Code	Ccl	Φ x Ht cm	Sur.	Prix HT
A . 75 34 430	15	6,8 x 18,5	6	3,36
A . 75 34 433	21,5	5,9 x 20	24	4,14
B . 75 36 105	14	6 x 19,1	24	3,40

Code	Ccl	Φ x Ht cm	Sur.	Prix HT
C . 75 36 014	16	6,4 x 18,5	24	3,94
D . 75 41 619	19,5	7 x 22,6	6	2,53
Boîte de 3 verres				
E . 16 18 597	22,5	6,9 x 22,6	12	5,04

Code	Ccl	Φ x Ht cm	Sur.	Prix HT
F . 75 34 645	21	6,5 x 22	24	4,07
G . 75 34 672	21	7,5 x 22,1	12	3,70

Solides



H . Tulip



I . Florence  
(lot de 3)



J . Noa  
(lot de 3)



K . Timeless  
(Boîte de 4)



L . Esprit



M . Essence



N . Silhouette



O . West Loop

Code	Ccl	Φ x Ht cm	Sur.	Prix HT
H . 75 41 285	20	6,5 x 20,5	24	1,50
I . 16 18 377	23	6,2 x 22,7	18	5,50

Code	Ccl	Φ x Ht cm	Sur.	Prix HT
J . 16 18 834	17,5	6 x 22,5	8	5,92
K . 16 13 188	17,5	6,4 x 22,5	4	13,40
L . 75 42 074	21	6,3 x 21,4	6	3,06

Code	Ccl	Φ x Ht cm	Sur.	Prix HT
M . 16 13 064	19	6,5 x 22,5	6	1,35
N . 75 11 329	18	6,4 x 18,1	24	2,98
O . 75 10 814	14	5,3 x 20,5	12	4,55



P . Vina



Q . Elisa



R . Princesa



S . Equip home



T . Normandie



U . Reims



V . Savoie



W . Elégance

Code	Ccl	Φ x Ht cm	Sur.	Prix HT
P . 75 10 034	19	5,5 x 22,5	24	2,97
Q . 75 10 617	17	5,3 x 19,2	48	3,28
R . 75 10 610	15	5,4 x 19,5	24	3,01

Code	Ccl	Φ x Ht cm	Sur.	Prix HT
S . 75 10 831	17	6 x 17,5	24	2,05
T . 75 10 504	14	5,2 x 17,3	48	3,33
U . 75 10 892	14	6 x 15,6	12	1,35

Code	Ccl	Φ x Ht cm	Sur.	Prix HT
V . 75 10 040	17	6,1 x 17	48	2,24
W . 75 11 269	17	5,5 x 17,5	48	2,38
W . 75 11 267	13	4,7 x 17,9	48	2,76
W . 75 11 266	10	4,7 x 15,9	48	2,50

Flûtes cocktails



A . Michelangelo

B . Supremo

C . Roma

D . Bach

E . Néo

F . Oslo

G . Zénith

Code	Ccl	Φ x Ht cm	Sur.	Prix HT
A . 75 36 014	16	6,4 x 18,5	24	3,94
B . 75 36 461	24	6,4 x 25	24	5,15

Code	Ccl	Φ x Ht cm	Sur.	Prix HT
C . 75 36 264	24	7 x 24,4	24	4,96
D . 75 36 469	21	5,3 x 23,5	24	5,47

Code	Ccl	Φ x Ht cm	Sur.	Prix HT
Boîte de 6 verres				
E . 79 35 048	20	6,8 x 22	4	14,30
F . 79 35 028	20	4,9 x 21	8	12,80
G . 79 35 018	19	6 x 21,7	4	19,50

Cristallin



H . Sublym

I . Open up

J . Cabernet

K . Cabernet

L . Séquence impérial

M . Sensation Exalt

Code	Ccl	Φ x Ht cm	Sur.	Prix HT
H . 75 10 914	21	7 x 24	24	4,42
I . 75 10 926	20	7,4 x 23,4	24	6,29
J . 75 10 411	16	7 x 22,5	24	3,60

Code	Ccl	Φ x Ht cm	Sur.	Prix HT
K . 75 10 410	24	6,2 x 23,5	24	4,00
L . 75 11 188	24	7 x 23,5	24	4,00
M . 75 10 673	19	7 x 21	24	3,62



N . Exaltation

O . Évidence

P . Symétrie

Q . Symétrie

R . Distinction

S . V.Juliette

T . Séquence

Code	Ccl	Φ x Ht cm	Sur.	Prix HT
N . 75 10 826	35	8,1 x 23,5	6	4,59
N . 75 10 825	30	7,8 x 21,1	6	4,23
O . 75 11 318	16	6,2 x 19	24	3,44

Code	Ccl	Φ x Ht cm	Sur.	Prix HT
P . 75 11 296	21	6,5 x 24	24	4,88
Q . 75 11 283	23	7 x 23,3	24	4,01
R . 75 11 295	16	6,5 x 19,8	24	4,23

Code	Ccl	Φ x Ht cm	Sur.	Prix HT
S . 75 10 358	22	6,5 x 21,7	24	3,28
T . 75 10 865	17	5,6 x 20,8	24	4,00

## Barware - Mixology

### Tiki

Cocktail tropical style hawaïen.

**oris**



**A . Bamboo Tiki**      **B . Tiki Splits**      **C . The Glitch**

Code	Ccl	Φ x Ht cm	Sur.	Prix HT
A . 75 42 286	46,5	6,8 x 17,2	6	4,18
B . 75 42 285	47	9,6 x 11,4	6	3,86
C . 75 42 258	40	6,5 x 15	6	4,56



### Tiki

Verre transparent non trempé.



**D . Pineapple**      **E . Chope**

Code	Ccl	Φ x Ht cm	Sur.	Prix HT
D . 75 42 284	53	8 x 14	12	6,93
E . 75 34 856	58	8,8 x 16,5	6	3,80



**F . Pulcinella (lot de 4)**      **G . Venezia (lot de 4)**

Code	Ccl	Φ x Ht cm	Sur.	Prix HT
Boîte de 4 verres				
F . 19 46 032	45	7,6 x 13,6	2	34,44
G . 19 46 033	45	7,6 x 13,6	2	34,44



**H . Sardinia (lot de 4)**      **I . Etruria (lot de 4)**

Code	Ccl	Φ x Ht cm	Sur.	Prix HT
Boîte de 4 verres				
H . 19 46 025	46	7,6 x 13,6	2	34,44
I . 19 46 026	45	7,6 x 13,6	2	34,44



**J . Fontaine**

**K . Mug**

Code	Ccl	Φ x Ht cm	Sur.	Prix HT
J . 16 05 028	400	16,4 x 26	4	7,50
J . 16 05 029	800	19,5 x 31,5	4	13,50
K . 16 05 080	45	6,5 x 14	12	1,75
L . 75 31 015	41,5	9,3 x 13,6	12	3,65



### Bartender Mules

Sweet et Sour sont accompagnés par les 3 mules en verre.



**M . Sour**

**N . Sweet**

**O . Moscow**

**P . Mojito**

**Q . Julep**

Code	Ccl	Φ x Ht cm	Sur.	Prix HT
M . 75 34 854	45,5	8,5 x 11,7	6	3,61
N . 75 34 855	44	8,5 x 11,7	6	3,61
O . 75 34 851	54	8,7 x 10,6	6	3,47

Code	Ccl	Φ x Ht cm	Sur.	Prix HT
P . 75 34 853	38	8,7 x 11,8	6	2,85
Q . 75 34 852	36,5	8,7 x 11,5	6	2,85

## Serenity

Trempe et parfaitement empilables.



A . FH



B . FH



C . FB



D . FB

Code	Ccl	Φ x Ht cm	Sur.	Prix HT
------	-----	-----------	------	---------

Lot de 3 verres				
A . 16 13 114	35,5	8,5 x 12,5	8	4,45
B . 16 13 113	26,5	7,5 x 12	16	4,21

Code	Ccl	Φ x Ht cm	Sur.	Prix HT
------	-----	-----------	------	---------

Lot de 3 verres				
C . 16 13 112	25,5	8,2 x 9	8	4,14
D . 16 13 111	21	8 x 8,5	8	4,04
D . 16 13 110	6	4,5 x 5,5	12	5,98

## Next

Verre trempé empilable



E . FH



F . FB

Code	Ccl	Φ x Ht cm	Sur.	Prix HT
------	-----	-----------	------	---------

E . 75 41 162	28	7,3 x 11,8	12	1,32
F . 75 41 161	20	7,1 x 9,6	12	0,92
F . 75 41 160	16	6,6 x 7,9	12	0,92



novastyl



G . Chope Mojito non trempé

Code	Ccl	Φ x Ht cm	Sur.	Prix HT
------	-----	-----------	------	---------

G . 16 13 140	36,5	8 x 12	24	1,61
---------------	------	--------	----	------

## Casablanca

Verre trempé.



## Chicago

Verre non trempé.

novastyl



H . FH



H . FH



I . FB



I . FB



J . FB



K . FH



K . FH

Code	Ccl	Φ x Ht cm	Sur.	Prix HT
------	-----	-----------	------	---------

H . 75 41 198	47,5	8,6 x 16,2	24	2,07
H . 75 41 196	36,5	8 x 14,8	48	1,50
H . 75 41 197	35,5	8 x 12	48	1,38
H . 75 41 192	28	7,8 x 12	48	1,21

Code	Ccl	Φ x Ht cm	Sur.	Prix HT
------	-----	-----------	------	---------

I . 75 41 194	35,5	9,2 x 10	24	1,55
I . 75 41 193	27	8,6 x 9,2	36	1,27
I . 75 41 195	20	7,5 x 8	24	1,09
J . 75 41 191	3,6	4,8 x 5,5	144	0,75

Code	Ccl	Φ x Ht cm	Sur.	Prix HT
------	-----	-----------	------	---------

Boîte de 6 verres				
K . 16 18 083	4,5	4,9 x 5,6	4	4,50
Boîte de 3 verres				
K . 16 18 610	20	7,9 x 8,2	8	2,99
K . 16 18 611	30	8,7 x 9,5	8	4,01
K . 16 18 612	30	8 x 12,2	8	4,01

Chopes barware



**Novecento**

Verres empilables non trempé au look vintage.

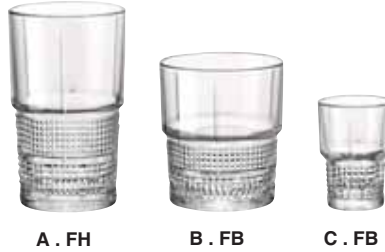

Code	Ccl	Φ x Ht cm	Sur.	Prix HT
A . 75 34 501	40,5	8 x 13,5	24	3,47
B . 75 34 500	37	8,7 x 10,1	24	3,47
C . 75 34 502	7,7	5,5 x 7,9	24	2,30

**Oxford bar**

Verre trempé conique et parfaitement empilable.

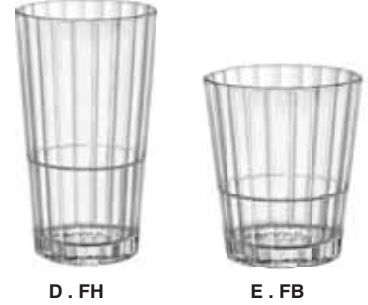

Code	Ccl	Φ x Ht cm	Sur.	Prix HT
D . 75 34 163	39,5	8,2 x 14,3	24	3,22
E . 75 34 162	37,4	8,9 x 10,4	24	2,76
E . 75 34 161	31,2	8,5 x 9,9	24	2,51

**Este**

Des lignes droites entrelacées avec des motifs géométriques créant l'équilibre et l'harmonie.

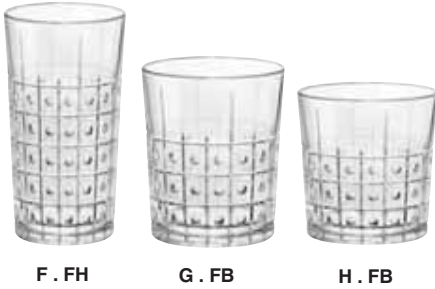

Code	Ccl	Φ x Ht cm	Sur.	Prix HT
F . 75 34 862	29	7,2 x 14	24	3,22
G . 75 34 861	37	9 x 10,7	24	3,54
H . 75 34 860	30	8,5 x 9	24	3,20

**Lounge**

Un motif de coupe aux lignes sophistiqués : idéal pour donner des effets lumineux



Code	Ccl	Φ x Ht cm	Sur.	Prix HT
I . 75 34 864	39	8,9 x 10,7	24	3,46
I . 75 34 863	27,5	8,2 x 8,8	24	3,66

**Stone**

Une représentation pierre précieuse vintage.



Code	Ccl	Φ x Ht cm	Sur.	Prix HT
J . 75 34 865	49	8,4 x 15,8	12	3,89

**Ypsilon**

Verre mécanique, conique avec fond lourd.



Code	Ccl	Φ x Ht cm	Sur.	Prix HT
K . 75 34 085	32	7,7 x 16	12	3,27
L . 75 34 086	34	10,1 x 11,7	24	3,77

Code	Ccl	Φ x Ht cm	Sur.	Prix HT
M . 75 34 087	25	9,2 x 10,7	24	2,62
N . 75 34 088	15	7,7 x 9,5	24	2,55



## Starline

Tendance Art Déco. Verre trempé.  
Compatible gravity



Code	Ccl	Φ x Ht cm	Sur.	Prix HT
A . 75 07 515	65	9,5 x 18	12	3,89
B . 75 07 514	46	8,5 x 16	12	3,09
C . 75 07 513	31	7,5 x 14	24	2,20

Code	Ccl	Φ x Ht cm	Sur.	Prix HT
D . 75 07 512	42	9 x 13	24	2,20
E . 75 07 511	35	8,5 x 12	48	2,20
F . 75 07 510	27	8,5 x 10	36	1,79

## Stack up

Verre trempé conique empilable.



## Stack up Cross

Tendance Art Déco. Verre trempé.

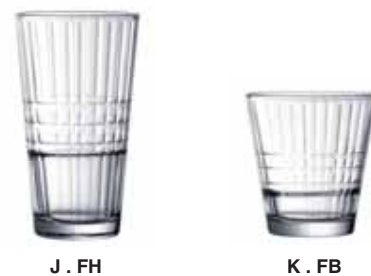

Code	Ccl	Φ x Ht cm	Sur.	Prix HT
G . 75 07 245	47	8,7 x 14,7	24	2,45
G . 75 07 244	40	8,3 x 14,4	24	2,20
G . 75 07 241	35	7,8 x 14	24	2,20
G . 75 07 240	29	7,6 x 11,9	24	2,20

Code	Ccl	Φ x Ht cm	Sur.	Prix HT
H . 75 07 239	4,5	5 x 6	48	1,35
I . 75 07 246	26	7,5 x 9,2	24	1,79
I . 75 07 243	32	9,2 x 9,2	24	1,98
I . 75 07 242	21	8,3 x 8	24	1,79

Code	Ccl	Φ x Ht cm	Sur.	Prix HT
J . 75 07 462	35	7,8 x 14	24	2,31
K . 75 07 461	26	8,5 x 9,2	24	1,89
K . 75 07 460	21	8,3 x 8	24	1,89

## Shetland

Verre non trempé Arcoroc.



## Brixton



Perception fond lourd avec un design géométrique.



Code	Ccl	Φ x Ht cm	Sur.	Prix HT
H . 75 06 074	42	8,8 x 14,6	48	2,44
H . 75 06 073	35	8,3 x 13,8	48	1,98
I . 75 06 072	22	7,2 x 12,2	48	1,77

Code	Ccl	Φ x Ht cm	Sur.	Prix HT
J . 75 06 069	15	7 x 9	48	1,81
J . 75 06 068	9	6 x 7,3	48	1,51
K . 75 06 071	32	9,7 x 9,6	48	2,02
K . 75 06 070	25	9 x 8,8	48	1,77

Code	Ccl	Φ x Ht cm	Sur.	Prix HT
D . 75 07 290	30	8,6 x 9,6	12	3,09



## Gobelets et chopes trempé

## New York

Verre trempé et empilable, inspiré de la tendance vintage, un trait distinctif commun sur tous les gobelets : un renflement au tiers du gobelet souligne la déclinaison des moules.

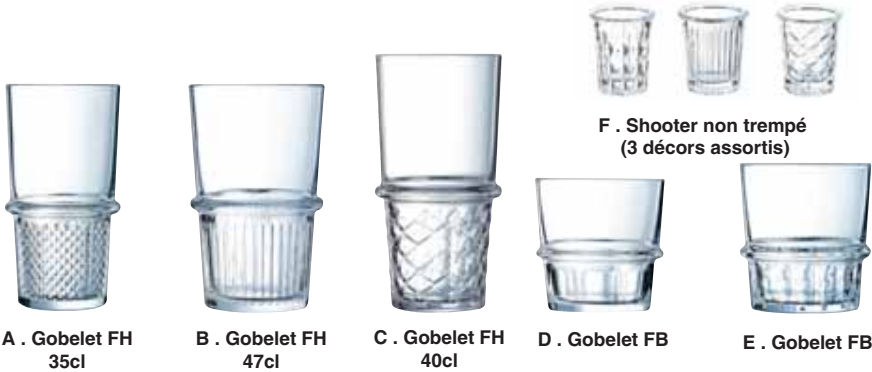

Code	Ccl	Φ x Ht cm	Sur.	Prix HT
A . 75 07 343	35	7,4 x 14,4	24	2,81
B . 75 07 344	47	8,7 x 14,4	24	3,07
C . 75 07 342	40	7,7 x 15,5	24	2,97

Code	Ccl	Φ x Ht cm	Sur.	Prix HT
D . 75 07 340	25	8,1 x 8,4	24	2,24
E . 75 07 341	38	8,9 x 10	24	2,78
F . 75 07 338	3,4	4,4 x 5,5	24	1,23



## Arcadie

Verre trempé. Un design relancé.

ARCOROC



Code	Ccl	Φ x Ht cm	Sur.	Prix HT
G . 75 07 454	40	9,3 x 12,6	24	2,76
H . 75 07 453	35	9,6 x 9,8	24	2,38
I . 75 07 452	24	8,5 x 8,6	24	1,53

Code	Ccl	Φ x Ht cm	Sur.	Prix HT
J . 75 07 451	16	7,3 x 7,3	24	1,50
K . 75 07 450	9	6,2 x 6,3	24	1,35



## Log

Ergonomiques et empilables.



L . FB

Code	Ccl	Φ x Ht cm	Sur.	Prix HT
L . 75 07 331	16	6,3 x 8	48	1,44
L . 75 07 332	27	7,6 x 9,3	48	1,53
L . 75 07 330	22	7,3 x 7,9	48	1,44



## Eskale

Inspirée du design des pots à confiture.



A . Gobelet FH



B . Gobelet FH



C . Gobelet FH

Code	Ccl	Φ x Ht cm	Sur.	Prix HT
A . 75 15 288	9	6,2 x 6,4	24	1,75
B . 75 15 287	18	7,7 x 7,8	24	1,91
C . 75 15 286	31	9 x 8,7	24	2,36

## Granity

Verre trempé



D . FH



E . FH



F . FB 35cl



F . FB 4.5 cl

Code	Ccl	Φ x Ht cm	Sur.	Prix HT
D . 75 07 082	65	9,6 x 17,8	12	3,45
D . 75 07 083	46	8,7 x 16	24	2,39
D . 75 07 084	42	8,9 x 13	24	2,14
D . 75 07 085	35	8,5 x 12,1	6	2,14
E . 75 07 087	31	7,5 x 14	6	2,14
E . 75 07 088	20,4	6,4 x 12,7	24	1,75

Code	Ccl	Φ x Ht cm	Sur.	Prix HT
F . 75 07 079	35	9,3 x 10,7	24	1,91
F . 75 07 092	27	8,5 x 9,8	6	1,75
F . 75 07 094	20	8 x 8,1	24	1,75
F . 75 07 089	16	7,3 x 7,3	48	1,50
F . 75 07 093	4,5	5 x 5,7	48	1,31

## Norvège

Verre trempé empilable



G . FH



H . FB

Code	Ccl	Φ x Ht cm	Sur.	Prix HT
G . 75 07 479	27	7,2 x 11,3	24	1,63
H . 75 07 478	25	7,5 x 9,4	24	1,44
H . 75 07 477	20	7,1 x 8,8	24	1,17
H . 75 07 476	16	6,5 x 8,2	24	1,17



## Nonic

Verre trempé empilable



I . FH



J . FB

Code	Ccl	Φ x Ht cm	Sur.	Prix HT
I . 75 07 077	57	8,6 x 15,1	48	2,05
J . 75 07 076	34	7,6 x 12,7	48	1,62
J . 75 07 075	28	7,3 x 11,4	48	1,58

## Campus

Verre trempé empilable



## Élisa - Oxygène - Forum

Verre trempé



K . FH



L . FB

Code	Ccl	Φ x Ht cm	Sur.	Prix HT
K . 75 07 022	29	6,6 x 12,8	48	1,46
L . 75 07 021	22	6,5 x 9,7	48	1,44
L . 75 07 020	18	5,6 x 8,5	48	1,44



M . Elisa



N . Oxygène



O . Forum

Code	Ccl	Φ x Ht cm	Sur.	Prix HT
M . 75 07 147	23	7,3 x 8,2	24	1,61
N . 75 07 152	16	6,8 x 8,1	72	1,17
O . 75 07 484	23	7,7 x 8,1	48	1,44
O . 75 07 483	16	6,9 x 7,2	48	1,17

## Gobelets et chopes couleurs



## Picardie

Verre trempé. Le Picardie 22cl est désormais toléré à 20cl.



A . Transparent

B . Transparent

C . Marine 25cl  
(Teintés dans la masse)

D . Gris 25cl

E . Picardie 25cl  
(Teintés dans la masse)

Code	Ccl	Φ x Ht cm	Sur.	Prix HT
A . 75 25 068	50	9,4 x 14,5	24	2,64
A . 75 25 073	36	8,8 x 12,4	48	2,04
A . 75 25 074	31	9 x 9,4	48	1,80
B . 75 25 064	25	8,7 x 9	72	1,52
B . 75 25 063	20	8 x 8,4	72	1,36

Boîte de 6 verres

B . 75 25 220	16	7,5 x 7,8	12	6,39
---------------	----	-----------	----	------

Code	Ccl	Φ x Ht cm	Sur.	Prix HT
B . 75 25 061	13	6,9 x 7,2	72	0,90
B . 75 25 060	9	6,5 x 6,7	144	0,88
C . 75 25 134	25	8,5 x 9	6	1,76
D . 75 25 130	25	8,5 x 9	6	1,80
E . 75 25 132	25	8,5 x 9	6	1,76

## Manhattan

Une gamme emblématique pour les cocktails, en verre trempé solide.



F . FB

G . FH

Code	Ccl	Φ x Ht cm	Sur.	Prix HT
F . 75 28 082	31	8,4 x 8,5	48	2,02
F . 75 28 080	22	7,3 x 8,5	72	1,45
G . 75 28 081	30,5	7 x 13,7	48	2,27

## Unie

Verre trempé.



H . Unie

H . Unie

Code	Ccl	Φ x Ht cm	Sur.	Prix HT
H . 75 26 009	33	7,7 x 12,4	48	1,85
H . 75 26 008	28	7,3 x 11,8	72	1,62

## Gigogne

Verre trempé.



I .

J .

Code	Ccl	Φ x Ht cm	Sur.	Prix HT
I . 75 25 027	22	7,9 x 7,7	72	1,21
I . 75 25 026	16	7 x 6,9	72	0,87
J . 75 25 025	9	5,8 x 6	72	0,81

## Lola

Verre trempé empilable.

■ Empilable



K . Gobelet

L . Gobelet

Code	Ccl	Φ x Ht cm	Sur.	Prix HT
K . 75 25 051	20	7,4 x 7,6	72	1,03
L . 16 05 140	16	7 x 7,1	12	5,52

Boîte de 6 verres

## Empilable

Verre trempé empilable.

■ Empilable



M . Gobelet

N . Gobelet

Code	Ccl	Φ x Ht cm	Sur.	Prix HT
M . 13 10 638	20	7,1 x 9,6	12	6,96
N . 75 25 020	16	6,6 x 7,9	72	1,02

Boîte de 6 verres

Pièces

## Prisme

Verre trempé.



O . FB

Code	Ccl	Φ x Ht cm	Sur.	Prix HT
O . 75 26 105	22	7,8 x 8,2	48	1,35

## Barshine

Verre trempé empilable



A . Chope FH



B . Chope FB

Code	Ccl	Φ x Ht cm	Sur.	Prix HT
A . 75 34 623	38	8,3 x 12,1	24	3,22
B . 75 34 622	39,5	9,1 x 10,1	36	2,77
B . 75 34 621	30,5	8,4 x 9,2	36	2,51
B . 75 34 613	21	7,6 x 8,4	24	2,25



## Rock bar

Verre trempé empilable



C . FH



D . FB

Code	Ccl	Φ x Ht cm	Sur.	Prix HT
C . 75 25 081	37	8,3 x 12	36	1,50
D . 75 25 058	20	7,6 x 8,3	36	1,38
D . 75 25 070	27	8,2 x 8,7	36	1,31
D . 75 25 072	7	5,1 x 6,3	54	1,10



## Rock bar lounge

Empilable. Coloré dans la masse. Passe au lave-vaisselle.



E . Peach FB



F . Mint FB



G . Blue FB

Code	Ccl	Φ x Ht cm	Sur.	Prix HT
E . 75 34 510	27	8,4 x 9,3	24	2,47
F . 75 34 511	27	8,4 x 9,3	24	2,47
G . 75 34 512	27	8,4 x 9,3	24	2,47

## Barshine color

Empilable coloré dans la masse



H . Ice



I . Mint



J . peach

Code	Ccl	Φ x Ht cm	Sur.	Prix HT
H . 75 34 590	30,5	8,4 x 9,2	36	3,13
I . 75 34 598	30,5	8,4 x 9,2	36	3,13
J . 75 34 595	30,5	8,4 x 9,2	36	3,13

## Diamond

Design à facettes, effet diamant. En verre coloré dans la masse.



K . Transparent



L . Purple



M . Blue

Code	Ccl	Φ x Ht cm	Sur.	Prix HT
K . 75 34 519	30	8,4 x 9,25	6	2,20
L . 75 34 524	30	8,4 x 9,25	6	2,53
M . 75 34 522	30	8,4 x 9,25	6	2,53



## Lyon

Verre trempé empilable



N .



O . Ramequin

Code	Ccl	Φ x Ht cm	Sur.	Prix HT
N . 75 25 018	16	6,6 x 7,9	48	1,01
N . 75 25 019	20	7,1 x 8,6	36	1,09
O . 75 28 125	14	8,5 x 4,1	36	1,17

## Habana

Verre trempé



P .



Q .

Code	Ccl	Φ x Ht cm	Sur.	Prix HT
P . 75 25 053	22	7,7 x 8,2	12	1,38
Q . 75 25 052	16	7 x 7,5	12	1,13

## Bodéga

Verre trempé.



R . FH



S . FB

Code	Ccl	Φ x Ht cm	Sur.	Prix HT
R . 75 25 087	50	8,8 x 12	36	1,38
R . 75 25 086	37	8,5 x 8,9	36	1,20
S . 75 25 085	20	8 x 5,7	36	0,87

Gobelets et chopes



### Carré Top Class



Verre cristallin. Base carré, design minimaliste mais moderne.



A .



B .

Code	Ccl	Φ x Ht cm	Sur.	Prix HT
A . 75 36 534	41	6,8 x 15,1	24	4,28
B . 75 36 532	35	8,3 x 9	24	4,13
B . 75 36 531	28,5	7,9 x 8,4	24	4,13



### Top Class rond

Design cylindrique parfaitement droit, sobre et pur, léger mais résistant, en verre ultra-blanc et transparent.



C . FH



D . FH

Code	Ccl	Φ x Ht cm	Sur.	Prix HT
C . 75 36 527	44	7,9 x 10,7	24	3,56
D . 75 36 526	37	6,6 x 13	24	3,56
D . 75 36 525	35	7,9 x 8,8	24	3,40

### Amétista

Le verre "œnologue" sans pied.



E . FH



F . FB

Code	Ccl	Φ x Ht cm	Sur.	Prix HT
E . 16 15 300	46	8,7 x 12	24	4,26
F . 16 15 301	34	8,7 x 9,1	24	4,07

### Diamante

Verre cristallin



G . FB



H . FH

Code	Ccl	Φ x Ht cm	Sur.	Prix HT
G . 75 36 253	38	8,4 x 9,6	24	5,03
H . 75 36 269	48	7,2 x 15,7	24	6,32



### Roma

Verre cristallin



I . FB



J . FH

Code	Ccl	Φ x Ht cm	Sur.	Prix HT
I . 75 36 262	30	8 x 8,4	24	4,64
J . 75 36 263	40	7 x 14,2	24	5,03

### Son'hyx®

Verre cristallin.



K . Supremo

Code	Ccl	Φ x Ht cm	Sur.	Prix HT
K . 75 36 463	45	10 x 9,8	24	3,62

### Bach



Chopes à facettes fond lourd / design barware.



L . FH



M . FH

Code	Ccl	Φ x Ht cm	Sur.	Prix HT
L . 75 36 472	36	6,4 x 15,5	24	4,42
M . 75 36 470	25,5	7,5 x 9	24	4,26
M . 75 36 471	33,5	8,3 x 9,7	24	4,77



## Chopes Boules

Verre mécanique.

A . Sand  
FH (x4)B . Sand  
FB (x4)C . Mixte  
Monté-carloD . Impérial  
FB

E . Essence



F . L'esprit du vin

Code	Ccl	Φ x Ht cm	Sur.	Prix HT
Boîte de 4 verres				
A . 16 18 332	51	7,6 x 14,5	6	6,70
B . 16 18 331	40,5	9,3 x 9,4	6	6,30

Code	Ccl	Φ x Ht cm	Sur.	Prix HT
C . 75 41 222	39	7,8 x 11	24	1,90
D . 75 41 077	31	7,8 x 8,7	12	1,55

Code	Ccl	Φ x Ht cm	Sur.	Prix HT
E . 16 13 065	35	8 x 10	6	1,46
F . 75 42 075	33	8,5 x 9,9	6	2,92

## Convexes

Verre mécanique.

novastyl

## Diamond - Electra

Verre mécanique

## Silk - L'Eau

Verre non trempé.



G . Allegra

H . Mise en  
bouche (x6)I . Florence  
(x3)

J . Diamond



K . Electra



L . Silk



M . L'Eau

Code	Ccl	Φ x Ht cm	Sur.	Prix HT
G . 75 41 615	42,5	8,9 x 10,9	24	1,76
Lot de 6 verres				
H . 16 18 062	8	7,7 x 6	6	4,50
Lot de 3 verres				
I . 16 18 371	34	7,1 x 8,7	6	4,28

Code	Ccl	Φ x Ht cm	Sur.	Prix HT
J . 75 34 519	30	8,4 x 9,3	6	2,20
K . 75 34 420	38	8,4 x 10	24	3,01

Code	Ccl	Φ x Ht cm	Sur.	Prix HT
L . 75 34 004	30	8,2 x 10,7	36	2,53
M . 75 34 106	30	7,4 x 9,8	12	2,44

## Milano

Verre trempé.



## Luna

Verre non trempé.



## Inalto uno - Aurum

Verres Starglass.



N . FH



O . FB



P . FH



Q . FB



R . Inalto Uno FB



S . Aurum

Code	Ccl	Φ x Ht cm	Sur.	Prix HT
N . 75 34 208	40	7,5 x 13	12	2,60
O . 75 34 205	8	8,9 x 9,2	12	2,60
O . 75 34 206	30	8,2 x 8,5	12	2,36

Code	Ccl	Φ x Ht cm	Sur.	Prix HT
P . 75 30 092	34	7,6 x 13,7	12	2,90
Q . 75 30 090	26	8 x 9,7	12	2,50
Q . 75 30 091	34	8,7 x 10,8	12	3,19

Code	Ccl	Φ x Ht cm	Sur.	Prix HT
R . 75 34 462	35	8,5 x 9,5	24	2,99
S . 75 34 457	44,5	8,5 x 10,7	24	3,38
S . 75 34 406	37	8,3 x 9,5	12	3,11

## Gobelets et chopes

## Vina

Verre Arcoroc non trempé.



A . FH



B . FB

Code	Ccl	Φ x Ht cm	Sur.	Prix HT
A . 75 06 033	36	7,6 x 12,1	6	1,82
B . 75 06 032	34	8,9 x 8,3	6	1,82

## Outline



Verre Arcoroc non trempé, moderne et raffiné.



C . FH



D . FB

Code	Ccl	Φ x Ht cm	Sur.	Prix HT
C . 75 06 483	37	8,1 x 11,5	24	2,43
D . 75 06 482	32	8,6 x 8,7	24	2,43



## Maléa

Verre Arcoroc non trempé.



E .



F .

Code	Ccl	Φ x Ht cm	Sur.	Prix HT
C . 75 06 111	40	7,2 x 14,9	12	1,41
C . 75 06 110	33	6,7 x 14,3	12	1,29

## Maléa

Verre Arcoroc non trempé.



G . FH



H . FB

Code	Ccl	Φ x Ht cm	Sur.	Prix HT
I . 75 06 401	35	7,6 x 12,6	24	2,15
J . 75 06 400	30	7,7 x 10,5	24	2,15

## Vina



Bord mince et fond allégé sur la forme angulaire.



I . FH



J . FB

Code	Ccl	Φ x Ht cm	Sur.	Prix HT
D . 75 06 432	40	8,7 x 11	24	2,02
E . 75 06 430	35	9,4 x 8,3	24	2,02

## Salto

Chopes boule transparente fond lourd.



■ Teintée dans la masse



K . FB



L . FB



M . FH

Code	Ccl	Φ x Ht cm	Sur.	Prix HT
K . 75 06 108	6	4,8 x 6,6	48	1,55
L . 75 06 086	32	9 x 8,4	24	1,91
M . 75 06 085	35	7,6 x 12,1	24	1,91

N . Red FH  
(spray)O . Red FB  
(spray)

Code	Ccl	Φ x Ht cm	Sur.	Prix HT
N . 75 06 283	35	7,6 x 12,1	24	4,40
O . 75 06 225	32	9 x 8,4	24	4,40



Q . Salto Ice Blue FH



R . Salto Ice Blue FB

Code	Ccl	Φ x Ht cm	Sur.	Prix HT
Q . 75 06 115	35	7,6 x 12,1	24	2,20
R . 75 06 114	32	9 x 8,4	24	2,20

## Glen

Verre mécanique solide.



A . FH



B . FB

Code	Ccl	Φ x Ht cm	Sur.	Prix HT
Boîtes de 6 verres				
A . 16 18 291	35,5	7 x 14,5	4	15,00
B . 16 18 290	33	8,4 x 9	4	13,50

## Elégance

Verre mécanique solide.

*novastyl*



C . FB  
(x3)



D . FH  
(x3)

Code	Ccl	Φ x Ht cm	Sur.	Prix HT
Lot de 3 verres				
C . 16 18 497	31	8,4 x 8,7	10	6,25
D . 16 18 496	33,5	6,8 x 14	6	4,25



## Club surf toros



F . Club-Space  
(x4)



G . Surf-Toros  
(x4)



H . Toros

Code	Ccl	Φ x Ht cm	Sur.	Prix HT
Boîte de 4 verres				
F . 16 11 965	20	6,8 x 9,95	48	1,95
Lot de 4 verres				
G . 16 11 970	20	6,8 x 9,8	12	1,95
Pièce				
H . 75 41 093	26	6,6 x 13,2	48	0,75



ARCOROC



I . Plain can



I . Autonomy

Code	Ccl	Φ x Ht cm	Sur.	Prix HT
I . 75 07 347	26	7,5 x 13,4	24	2,24
I . 75 07 470	30	9,2 x 11,5	12	2,46

## Chopes apéritif



J . Bonita FH  
(x4)



K . Bonita FB  
(x4)



M . Aéré



N . Tapas fd léger



O . Génération  
(x3)



P . Bodega  
(x4)



Q . Arosa

Code	Ccl	Φ x Ht cm	Sur.	Prix HT
Boîte de 4 verres				
J . 16 18 334	34,5	8,4 x 8,8	6	5,15
K . 16 18 333	24	8,2 x 5,8	6	4,55

Code	Ccl	Φ x Ht cm	Sur.	Prix HT
M . 75 34 320	28	7,4 x 8,8	12	2,05
N . 75 41 141	36	8,5 x 8,9	12	1,21

Code	Ccl	Φ x Ht cm	Sur.	Prix HT
Lot de 3 verres				
O . 16 13 235	25	8,4 x 8,7	48	2,16
Boîte de 4 verres				
P . 16 13 216	22,5	9 x 5,4	24	8,51
Q . 75 34 079	17	6,5 x 12	6	1,75

## Gobelets et chopes

## Conique

Verre trempé sauf le 8 cl. Désormais en boîte de 6.

ARCOROC

EXTRA  
RESISTANT  
FULLY TEMPERED GLASS

A . FH



B . FH



C . FH

D . Conique  
non trempé

Code	Ccl	Φ x Ht cm	Sur.	Prix HT
A . 75 07 499	64	9,1 x 16,1	24	2,05
A . 75 07 068	57	9 x 15	24	2,05
B . 75 07 498	47	8,7 x 13	24	1,98
C . 75 07 497	28	7 x 11,9	24	1,63

Code	Ccl	Φ x Ht cm	Sur.	Prix HT
C . 75 07 496	25	7 x 11,2	48	1,57
C . 75 07 495	20	6,5 x 10,5	48	1,57
D . 75 05 004	8	5 x 7,8	48	1,10

## Islande

Verre fond lourd non trempé.

ARCOROC



E . FH



F . FH



G . FH



H . FH



I . Tubo FH



J . Tubo FH



K . FH



L . FB



M . FB

Code	Ccl	Φ x Ht cm	Sur.	Prix HT
E . 75 06 501	36	6,4 x 17	24	1,47
F . 75 06 502	33	6,3 x 15,7	24	1,34
G . 75 06 500	31	5,9 x 16,6	24	1,47
G . 75 06 497	22	5,8 x 13	24	1,33

Code	Ccl	Φ x Ht cm	Sur.	Prix HT
H . 75 06 499	29	6,2 x 14,5	24	1,47
H . 75 06 495	16	5,5 x 10	24	1,33
I . 75 06 494	10	5,1 x 8,7	24	1,33
J . 75 06 498	22	5,3 x 15,2	24	1,33
J . 75 06 496	17	5,2 x 12,5	24	1,33

Code	Ccl	Φ x Ht cm	Sur.	Prix HT
K . 75 06 493	6,5	3,8 x 10,5	72	0,99
L . 75 06 490	38	8,9 x 9,6	24	2,29
L . 75 06 489	30	7,9 x 9,3	24	1,33
M . 75 06 488	20,5	7 x 8,3	24	1,33

## Amsterdam - Stockholm

Verre non trempé.

N . Amsterdam  
FHO . Stockholm  
FBP . Stockholm  
FB

Code	Ccl	Φ x Ht cm	Sur.	Prix HT
N . 75 05 010	27	6,2 x 13,5	6	1,10
O . 75 05 027	27	7,6 x 9,2	6	1,30
P . 75 05 024	4,5	4,3 x 5,2	48	0,97



## Caravelle

Verre mécanique.



Q . FB



R . FB

Code	Ccl	Φ x Ht cm	Sur.	Prix HT
S . 75 30 005	15,5	6,5 x 7	24	1,43
R . 75 30 006	10	5,7 x 6,8	24	0,92
R . 75 30 007	5,3	4,4 x 5,4	48	0,87

## Village

Excellente prise en main grâce au col en V. Indication trait de jauge



■ Trait de jauge



A . Carafon Village  
trait de jauge



B . 50 cl



C .



Code	Ccl	Φ x Ht cm	Sur.	Prix HT
A . 16 11 722	100	9 x 24,9	6	4,54
B . 16 11 721	50	7,9 x 20,3	6	3,40

Code	Ccl	Φ x Ht cm	Sur.	Prix HT
C . 16 11 720	25	6 x 17,2	16	2,82



## Swing top

Verre mécanique.



D . 100cl



E . 50cl

Code	Ccl	Φ x Ht cm	Sur.	Prix HT
D . 15 10 231	100	8,7 x 32,3	3	3,20
E . 15 10 230	50	6,9 x 29	3	2,75

## Giara

Verre mécanique.



F . 100 cl



G . 50 cl

Code	Ccl	Φ x Ht cm	Sur.	Prix HT
F . 75 34 337	100	8,6 x 30,6	6	3,08
G . 75 34 330	50	7,7 x 25,3	12	2,69

## Fun color

Verre mécanique.

novastyl



I . Fun

COULEURS  
ASSORTIES

Code	Ccl	Φ x Ht cm	Sur.	Prix HT
I . 16 11 368	100	8,5 x 32	6	2,50

## Fraîcheur

Bouteille avec bouchon à vis Twist off.



J . 100 cl



K . 50 cl

Code	Ccl	ø. x Ht cm	Sur.	Prix HT
J . 15 10 236	100	8,4 x 25,2	6	1,80
K . 15 10 235	50	6,7 x 19	6	1,55



## City

Verre mécanique.

novastyl



L . 100 cl



M . 50 cl

Code	Ccl	Φ x Ht cm	Sur.	Prix HT
L . 16 18 251	100	6,8 x 25	6	2,80
M . 16 18 250	50	6,8 x 20,3	12	2,15

## Carafes et Bouteilles

## Optima

Le col solide assure une longévité au produit. Bords renforcés, faciles à servir.  
Indications et trait de jauge 25, 50, 75 cl et 1 litre. Bouchon à acheter séparément.



A . Carafe à eau



B . Carafe à vin



C . Carafe à vin



D . Bouchon

Code	Ccl	Φ x Ht cm	Sur.	Prix HT
A . 75 36 385	75	8 x 26	6	4,31
B . 75 36 380	25	6 x 19,6	12	3,57

Code	Ccl	Φ x Ht cm	Sur.	Prix HT
C . 75 36 381	50	7,1 x 26,2	6	4,92
D . 75 36 392		5,9 x 4,3	12	3,66

## Swing

Base carrée adaptée pour le service et le stockage. Verre mécanique.



E . 100 cl



F .

Code	Ccl	Φ x Ht cm	Sur.	Prix HT
E . 75 34 342	100	8,2 x 31,5	6	3,91
F . 75 34 341	50	6,8 x 25	12	3,39
F . 75 34 340	25	5,5 x 20,6	28	2,58
F . 75 34 343	12,5	5,9 x 13,4	20	2,83

## Oriente acqua

Originalité et convivialité, une véritable touche de modernité.



G . Carafe

Code	Ccl	Φ x Ht cm	Sur.	Prix HT
G . 16 64 001	100	8,5 x 35	6	7,22

## Elixir

Réalisé avec beaucoup de style, le flacon Elixir de 10 cl est parfait pour les cocktails ou les huiles aromatisées. Bouchon plastique.

H . Carrée  
10 clI . Ronde  
10 cl

Code	Ccl	Φ x Ht cm	Sur.	Prix HT
H . 75 36 440	10	5,7 x 13,5	24	7,67
I . 75 36 441	10	5,2 x 14,2	24	7,67

## Optima

Bouchon verseur acier inoxydable 18/8, joint silicone

J . Burette  
à huileK . Burette  
à vinaigre

Code	Ccl	Φ x Ht cm	Sur.	Prix HT
J . 75 36 394	25	7,4 - 5 x 14,3	12	6,64
K . 75 36 395	25	7,4 - 5 x 14,3	12	6,64
L . 75 36 393		2,5 x 12,5	1	4,00

L . Bec  
verseur

## Authentica



M . Bouteille jaugée avec bec verseur inox



Code	Ccl	Φ x Ht cm	Sur.	Prix HT
M . 75 36 343	52,5	6,9 x 31,3	6	6,34
jaugé 50 cl au col de la bouteille				
M . 75 36 342	27,3	5,8 x 26,1	6	5,61
jaugé 25 cl au col de la bouteille				

## Fluid

Design unique.

C . 75 15 299  
Bouchon seul

Une taille de bouchon pour les carafes Fluid : 1 L, 75 cl et 50 cl.

ARCOROC



A . Carafe



A . Carafe



B . Carafe



B . Carafe

Code	Ccl	Φ x Ht cm	Sur.	Prix HT
A . 75 15 290	100	10,7 x 26,5	6	9,20
A . 75 15 296	75	10,7 x 21	6	7,31

Code	Ccl	Φ x Ht cm	Sur.	Prix HT
B . 75 15 291	50	9,1 x 19,3	6	5,73
B . 75 15 292	25	7,1 x 13,5	12	4,55
C . 75 15 299		7 x 3,9	1	1,25



## Fluid Frosted

Couleur spray pour répondre à la problématique des traces de calcaire.



D . White



E . Bleu



F . Vert

Code	Ccl	Φ x Ht cm	Sur.	Prix HT
D . 75 15 325	75	9,6 x 21	6	8,06
E . 75 15 327	75	9,6 x 21	6	8,06

Code	Ccl	Φ x Ht cm	Sur.	Prix HT
F . 75 15 326	75	9,6 x 21	6	8,06



## Carafons vins

Verre non trempé.



G .



H .



I . Carafon carré



J .



K .

Code	Ccl	Φ x Ht cm	Sur.	Prix HT
G . 75 15 112	100	11,9 x 20,3	6	4,11
H . 75 15 111	50	9,8 x 16,4	12	2,74
H . 75 15 110	25	7,8 x 13,2	12	2,29

Code	Ccl	Φ x Ht cm	Sur.	Prix HT
I . 75 15 102	100	12 x 25,5	6	5,43
J . 75 15 101	50	9,6 x 19,9	12	3,16
K . 75 15 100	25	3,6 x 16,2	12	2,50



## Carafes et carafons

### Ensemble

Design et élégance en verre mécanique très solide.

on's



A.

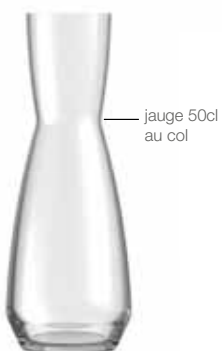

B.



C.

Code	Ccl	Φ x Ht cm	Sur.	Prix HT
A . 16 31 107	107	10 x 25	6	6,01
B . 16 31 106	74	8,9 x 24	6	3,99

Code	Ccl	Φ x Ht cm	Sur.	Prix HT
C . 16 31 105	33	7 x 16,8	12	3,54



### Carafes Ypsilon

Verre cristallin



D . Carafe jaugée col



D . Carafe jaugée col

Code	Ccl	Φ x Ht cm	Sur.	Prix HT
D . 16 16 650	100	10,4 x 25,5	6	8,40
D . 16 16 649	50	8,4 x 20,4	6	4,99
D . 16 16 648	25	6,8 x 16,5	12	3,85

### Exclusiva

Verre cristallin



E.



F.

Code	Ccl	Φ x Ht cm	Sur.	Prix HT
E . 75 34 389	100	10,2 x 22,5	6	9,82
F . 75 34 388	50	8,3 x 20,4	6	6,95
F . 75 34 387	25	6,7 x 16,5	12	4,81



### Atelier



«CE gauge marks». Cristallin SON.hyx®.



G . avec indication jauge

■ Trait de jauge



Code	Ccl	Φ x Ht cm	Sur.	Prix HT
G . 75 36 432	120 jg 100	10,8 x 28	6	8,67
G . 75 36 431	64 jg 50	9 x 22,5	6	5,53

### Lyonnais

Verre mécanique.



H.



I.

Code	Ccl	Φ x Ht cm	Sur.	Prix HT
H . 16 41 030	46	7 x 29	6	50,72
I . 16 41 031	25	6,3 x 22	6	45,72

Boîte de 6

### Misure

Verre mécanique.



J.



K.

Code	Ccl	Φ x Ht cm	Sur.	Prix HT
J . 16 16 157	100	10,8 x 26,2	6	5,93
K . 16 16 156	50	8,4 x 23,5	12	3,62
K . 16 16 155	25	6,8 x 19	12	2,88

Pichets verre

ARCOROC

novastyl



A . Quadro 50 cl



B . Quadro 120 cl



C . Frigo 105 cl



Pasabahçe  
LIVE BEAUTIFUL

Code	Ccl	Φ x Ht cm	Sur.	Prix HT
A . 75 15 019	50	12,8 x 15,6	6	5,35
B . 75 15 020	120	12,4 x 24,2	6	6,95

Code	Ccl	Φ x Ht cm	Sur.	Prix HT
C . 16 05 091	105	13 x 24	6	2,50

ARCOROC



D . Spring 100 cl



E . Spring 75 cl



F . Spring 50 cl



G . Pichet



G . Pichet



G . Pichet

jge trait  
25 - 50  
ou 100cl

Code	Ccl	Φ x Ht cm	Sur.	Prix HT
D . 75 15 087	100	13,4 x 21,8	6	4,52
E . 75 15 086	75	13,4 x 18,6	6	3,96

Code	Ccl	Φ x Ht cm	Sur.	Prix HT
F . 75 15 085	50	13,4 x 14,6	12	3,44
G . 16 10 135	30 jg 25	6 x 12	12	1,73

Code	Ccl	Φ x Ht cm	Sur.	Prix HT
G . 16 10 136	66 jg 50	8 x 15,5	6	2,53
G . 16 10 137	130 jg 100	9,5 x 20	6	3,39



H . Bistrot



H . Bistrot



H . Bistrot



I . Arc



J . Arc

ARCOROC

Code	Ccl	Φ x Ht cm	Sur.	Prix HT
H . 16 16 130	25	6,2 x 11,5	12	1,98
H . 16 16 131	50	7,7 x 14,5	12	2,74

Code	Ccl	Φ x Ht cm	Sur.	Prix HT
H . 16 16 132	100	9,2 x 18,6	6	4,09
I . 75 15 001	50	12,5 x 14,6	12	3,23

Code	Ccl	Φ x Ht cm	Sur.	Prix HT
J . 75 15 002	100	15,2 x 20,2	6	4,29
J . 75 15 003	130	13,9 x 21,7	6	5,39

Pichets grès

Renforcé blanc.

novastyl



K .



L .



M .



N .

Code	Ccl	Φ x Ht cm	Sur.	Prix HT
K . 29 40 432	12	7,5 x 8	4	2,00
L . 29 40 436	30	11 x 10,5	72	8,35

Code	Ccl	Φ x Ht cm	Sur.	Prix HT
M . 29 40 433	50	8-12 x 11,5	6	10,85

Code	Ccl	Φ x Ht cm	Sur.	Prix HT
N . 29 40 434	75	8,5-13 x 13	2	13,50

Carafes

novastyl

OGO



A . Rêverie



B . Rêverie anse



C . Viktor



D . Adam

Code	Ccl	Φ x Ht cm	Sur.	Prix HT
A . 16 11 634	150	15 x 21	6	14,95

Code	Ccl	Φ x Ht cm	Sur.	Prix HT
B . 16 11 635	150	20,5 x 23,5	4	16,50

Code	Ccl	Φ x Ht cm	Sur.	Prix HT
C . 79 12 052	65	10 x 21	6	16,50
D . 79 12 053	120	11,4 x 30	6	17,50

Pasabahçe  
LIVE BEAUTIFUL

novastyl



E . Timeless 140 cl



F . Timeless Mixing



G . Botanica



H . 1 L



I . 2 L

Code	Ccl	Φ x Ht cm	Sur.	Prix HT
E . 75 41 313	140	13,4 x 21,7	6	12,42
F . 75 41 318	72	10,5 x 14,5	6	7,19

Code	Ccl	Φ x Ht cm	Sur.	Prix HT
G . 16 13 440	190	18,5 x 27,5	6	11,35

Code	Ccl	Φ x Ht cm	Sur.	Prix HT
H . 16 05 092	100	13,3 x 19,7	6	5,50
I . 16 05 093	200	16,1 x 23,6	6	6,50



J . Macaron



K . Abundance

Code	Ccl	Φ x Ht cm	Sur.	Prix HT
J . 75 15 310	200	17,6 x 32,5	2	59,54

Code	Ccl	Φ x Ht cm	Sur.	Prix HT
K . 75 15 077	160	19 x 23,6	2	38,19



Séries



Galéa  
p.4



Mylla  
p.5



Open up  
p.6



Sublym  
p.6



Symétrie  
p.7



Distinction  
p.8



Primary  
p.9



Séquence  
p.9



Évidence  
p.9

Séries

ARCOROC



Lima  
p.10



Cabernet  
Vins jeune  
p.10



Sensation  
Exalt  
p.10



Cabernet  
Tulip  
p.11



Cabernet  
Ballon  
p.11



Cabernet  
Cocktail  
p.56



Flûtes  
champagne  
p.59



Disco  
p.29



V. Juliette  
p.30

Séries



Broadway  
p.31



Vina  
p.32



Viticole  
p.32



Éléance  
p.33



Silhouette  
p.33



Normandie  
p.34



Amélia  
p.34



Princesa  
p.35



Linéal  
p.35

Séries



Domaine  
p.35



Jolly  
p.55



Brio  
p.57



Shetland  
p.63



Stack up  
p.63



Starline  
p.63



Log  
p.64



New York  
p.64



Campus  
p.65

Séries

OGO



Nonic  
p.65



Granity  
p.65



Eskale  
p.65



FB Salto  
p.70



FH Salto  
p.70



FH Outline  
p.70



Islande  
p.72



Conique  
p.72



Zénith  
p.12

# Phototèque

## Séries

SCHOTT  
ZWIESEL



Néo  
p.12



Oslo  
p.13



Astral  
p.13



Mondial  
p.14



Vina  
p.14



Ivento  
p.15



Belfesta  
p.15



Classico  
p.17



Taste  
p.17

## Séries

Louis Borsari  
MADE IN ITALY



Michelangelo  
p.18



Rubino  
p.18



Diamante  
p.19



Linea Bach  
p.20



Roma  
p.21



Chianti  
Supremo p.21



Bach Crista  
p.68



Top Class  
p.68



Top Class  
Square  
p.68

## Séries

RCR



Timeless  
p.24



Alkemist  
p.26



Tiki Etura  
p.27



Aurum  
p.36



In Alto  
Tre Sensi  
p.36



Nexo  
p.36



Florian  
p.37



Celebrazione  
p.37



Esclusiva  
p.38

Narmal

## Séries



Snifter  
p.54



Mules  
p.60



Oxford  
p.62



Ypsilon  
p.63



Bodega  
p.67



Rock bar  
lounge  
p.67



Diamond  
p.67



Barshine  
p.67



Luna  
p.69

## Séries

Pasabahçe  
LIFE SOLUTIONS



Milano  
p.69



Arosa  
p.71



Timeless  
p.40



Elysia  
p.43



Essence  
p.44



Tulip  
p.44



Inao  
p.46



Enoteca  
Ballon  
p.46



Allegra  
p.46

Séries



Comptoir  
p.47



Ivory  
p.47



Next  
Empilable  
p.61



Casablanca  
p.61



Tapas  
fd léger  
p.71



Caldera  
p.45



Savage  
p.45



Picardie  
p.66



Unie  
p.66

Séries



Séries



Séries

Séries

*novastyl*



Manhattan  
p.66



Matignon  
p.48



Rhin  
p.48



Florence  
p.49



Noa  
p.49



Riviera  
p.50



Gatsby  
p.51



Génération  
p.71



Élégance  
p.71

Séries

*onis*



SPKSY  
p.52



Roma  
p.52



Adventure  
p.53



Pentagon  
p.53



Facets  
p.53



Hampshire  
p.53



ICON  
p.53



Tarq  
p.53



Pineapple  
p.53

Complément



Swing top  
p.73



Giara  
p.73



Village  
p.73



Fraîcheur  
p.73



Optima  
p.74



Huillier  
p.74



Carafon  
p.75



Carafe  
p.75



Misure  
p.76

Complément

Personnalisation



Ypsilon  
p.76



Pots  
p.76



Bistrot  
p.77



Pichets  
p.77



Brocs  
p.77



Pichets  
p.78



Décantier  
p.78



Séigraphie  
p.82



Gravure  
p.82

Personnalisation

### V.Juliette jaugé (grappe)

3 niveaux : 10 - 12,5 et 15 cl pour 3 contenances best-sellers



A . V.Juliette

Code	Ccl	Φ x Ht cm	Sur.	Prix HT
A . 75 10 313	30	7,8 x 18,8	24	3,82



### Cabernet jaugé (grappe)

Esthétique et discrète, la jauge est élégante sans trop s'imposer. Cristallin



B . Vins jeunes

C . Cabernet Tulipe

Code	Ccl	Φ x Ht cm	Sur.	Prix HT
B . 75 10 312	35	9 x 20	24	4,34
C . 75 10 314	35	8,1 x 20,2	24	4,34

### Viticole (ellipse) ARCOROC

Ces verres présentent une ellipse, véritable repère pour verser en un clin d'oeil les doses précises de vin, 14,5 ou 12,5 cl.



D . Viticole

Code	Ccl	Φ x Ht cm	Sur.	Prix HT
D . 75 11 082	21,5	6,5 x 15,5	48	3,29

### Cabernet (ellipse)

Cristallin



E . Tulip 35

Code	Ccl	Φ x Ht cm	Sur.	Prix HT
E . 75 10 403	35	8,1 x 20,2	24	4,34



### Inao

novastyl

Le véritable verre effilé cristallin Inao, bord fin coupé à froid.



F . Inao (x6)

Code	Ccl	Φ x Ht cm	Sur.	Prix HT
F . 19 71 885	21	6,5 x 16	8	12,05

Boîte de 6 verres

### Tester

Verre mécanique bord à chaud.

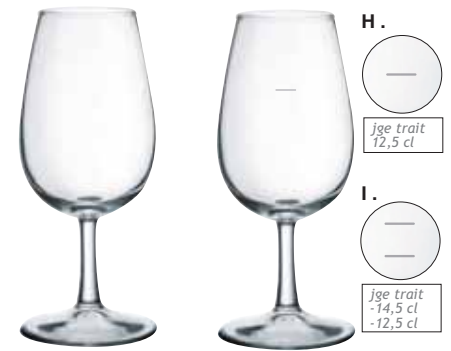

Code	Ccl	Φ x Ht cm	Sur.	Prix HT
G . 75 41 115	21,5	7 x 15,5	12	1,44
H . 75 41 442	21,5 jge12	7 x 15,5	12	2,27
I . 75 41 479	21,5 jge14-12	7x 15,5	12	2,27



## 1 Gravure laser

Nous proposons à partir de 19 références standard suivies et en stock.



7541658  
OSLO



7541377 / 6 / 5  
ZENITH



7541618  
ALLEGRA



7510355 / 6 / 7  
V. JULIETTE



7541656 / 655  
OSLO



7510445  
VIN JEUNE



7510670 / 7543349  
EXALT MONDIAL



7534201  
MILANO



7510620  
CERVOISE



7541369 / 7511029  
INAO / VITICOLE



1618250  
CITY



7935020  
ZÉNITH



7506239  
LIMA

## 2 Tarif Frais techniques 45,00 €

Supplément gravure par quantité *	Tarif HT Trait de jauge	Tarif HT Écriture simple détournée	Tarif HT gravure complexe ou remplie écriture épaisse (+4mm)		
	Moins de 10 secondes	Moins de 40 secondes	Environ 1 minute	Environ 1 min 30	Au-delà de 2 min
De 120 à 250 pièces	1.00€	1.32€	1.50€	1.68€	2.18€
De 251 à 600 pièces	0.83€	1.05€	1.25€	1.43€	1.93€
De 601 à 1000 pièces	0.75€	0.93€	1.13€	1.31€	1.81€
1001 pièces et plus	0.67€	0.83€	1.03€	1.21€	1.71€

## 5 EXEMPLE DE SÉRIGRAPHIE



La gravure laser sur verre permet une inscription très précise et garantit une longévité dans le temps. Le motif obtenu est un dépoli blanc satiné.

## 3 EXEMPLE DE GRAVURE



Jauge 12cl : 14 cm  
Dimensions du logo : 20.5mm

Zenith 35cl : 3.15€  
Supplément pour 250 pcs : 1.05€  
Total verre gravé = 4.20€ HT  
Frais techniques : 45€

Le bas du logo sert de jauge à 12cl.

Le logo Haute Définition (300 dpi)  
Format vectoriel : .ai / .eps

Les dimensions souhaitées du logo sur le verre  
Contrainte / largeur maximum / face de décoration visible

Le positionnement du logo sur le verre

Exemple: centré sur la face avant jauge basse à 12cl jauge naturelle sur tel repère

## 4 Personnalisation sur verre

Nous vous proposons aussi un autre procédé de décoration en sérigraphie couleur

### EMAIL EPOXY

> Panel de couleurs plus important (encres organiques)

À partir de 250 pièces minimum.

Nous consulter pour plus d'informations.



> Possibilité de décorer une plus grande surface

> En couleur toutes couleurs pantones simples (sauf or Et métalliques)

> Minimum 240 pcs

> Frais techniques 45,00 €

> Devis à la demande

> Tarif dégressif négociable avec les quantités

> Possible dépoli blanc imitation gravure

## PROCESSUS

### 1 SOUMETTRE VOTRE PROJET

Pour toute demande de personnalisation, un devis sur mesure vous est proposé, accompagné d'un dossier explicatif du processus.

### 3 CHOIX DU SUPPORT

#### Aperçu de vaisselle personnalisable

L'ensemble des supports disponibles sont présentés dans le dossier complet.



Plate



Creuse



Ovale



Bol

#### Aperçu numérique du design sous maquette

PDF fournis sous 2 jours ouvrés.

### 5 TARIFICATION

#### Tableau des prix

Notez que le prix du support n'est pas inclus dans ces tarifs.

Frais techniques : 50€

Quantité pièces*	Tarif HT Logo	Tarif HT Logo + Bordure
	1 couleur	3 couleurs
De 600 à 1000 pièces	0.85€	1.50€
De 1000 à 2000 pièces	0.70€	1.20€
De 2000 à 3000 pièces	0.60€	1.00€
De 3000 à 5000 pièces	0.45€	0.90€
De 5000 à 10000 pièces	0.40€	0.85€

\*Catégorie tarifaire soumise à validation par devis

**Précision :** un surcoût est appliqué pour chaque couleur additionnelle (Logo ou bordure).

### 2 BESOINS (À NOUS FOURNIR)

#### Fichier Haute Définition (300 dpi)

Format vectoriel : .ai / .eps

#### Choix des couleurs

► Aucune limite de principe quant au choix des couleurs Pantone, sous réserve de validation technique.



### 4 ÉCHANTILLONNAGE

#### Design approuvé

Échantillon(s) fournis pour un tarif de 150€ sous 3 semaines. (remboursé en cas de commande)



Logo seul



Logo & Bordure

### 6 PRODUCTION ET EXPÉDITION

#### Validation des maquettes / échantillons

Le processus de production finale commence et vos produits sont fabriqués et prêts à l'expédition sous 6 à 7 semaines\*.

\*1000 pcs ou plus la date de livraison peut varier. Vous rapprochez de nos services.

#### Exemple de personnalisation avec logo

Plate Lona : 5,60€  
 Nombres de pcs : 240 pcs  
 Supplément couleur/pc : 0.85€  
 Frais techniques : 50€  
 Total : 1598€ HT  
 Prix unitaire : 6,65€ pc



+ Pour toute demande de décors supplémentaires ou spécifiques, merci de nous contacter. Nous étudierons votre projet.

► Les informations sont à confirmer avant production et sont soumises à la validation de l'équipe technique.

## PROCESSUS DÉCORATION RÉALISÉE EN FRANCE



### 1 SOUMETTRE VOTRE PROJET

Lorsque vous nous contactez pour une demande de personnalisation, nous vous fournirons un devis sur mesure, ainsi qu'un dossier complet expliquant les étapes du processus.

### 3 CHOIX DU SUPPORT

#### Aperçu de vaisselle personnalisable

L'ensemble des supports disponibles sont présentés dans notre dossier complet.



#### Aperçu numérique du design sous maquette

PDF fournis sous 2 jours ouvrés.

### 5 TARIFICATION

#### Tableau des prix PHR

Notez que le prix du support et le transport n'est pas inclus dans ces tarifs.

Frais techniques : 50€

Quantité pièces*	Tarif HT Logo	Tarif HT Logo + Bordure
	1 couleur	1 couleur
De 96 à 199 pièces	2.25€	4.50€
De 199 à 299 pièces	1.85€	3.95€
De 300 à 499 pièces	1.65€	3.75€
De 500 à 799 pièces	1.35€	3.55€
De 800 à 1000 pièces	1.25€	3.45€
+ 1000 pièces	1.15€	3.30€
+ 2000 pièces	1.05€	3.25€

\*Catégorie tarifaire soumise à validation par devis

Précision : un surcoût de 0,50 est appliqué pour chaque couleur additionnelle (Logo ou bordure).

### 2 BESOINS (À NOUS FOURNIR)

#### Fichier Haute Définition (300 dpi)

Format vectoriel : .ai / .eps

#### Limites de couleur

**4 couleurs** maximum pour les logos.

**6 couleurs** maximum pour les décors de bordure.

#### PALETTE DE COULEURS PERSONNALISABLE

Pour personnaliser vos décors et bordures, merci de nous communiquer vos références Pantone.

Si besoin de couleur spécifique, nous préciser les éléments et comptez 10 jours supplémentaires de production.



### 4 ÉCHANTILLONNAGE

#### Design approuvé

Échantillon(s) fournis pour un tarif de 150€ sous 3 semaines. (remboursé en cas de commande)



### 6 PRODUCTION ET EXPÉDITION

#### Validation des maquettes / échantillons

Le processus de production finale commence et vos produits sont fabriqués et prêts à l'expédition sous 6 à 7 semaines\*.

\*3000 pcs ou plus la date de livraison peut varier. Vous rapprochez de nos services.

#### Exemple de personnalisation avec logo sur assiette plate Ø21cm

Plate Thera : 2,16€  
 Nombres de pcs : 600 pcs  
 Supplément couleur/pc : 1,35€  
 Frais techniques : 50€  
 Total : 2156€ HT  
 Prix unitaire : 3,56€ pc



+ Pour toute demande de décors supplémentaires ou spécifiques, merci de nous contacter. Nous étudierons votre projet.

## Les Nouveautés vaisselle

**OGO**

**ID Fine**



### **Sigma**

Artisanale et authentique en porcelaine.



### **Reckless**

Sombre et sophistiquée : un noir anthracite résistant en porcelaine.

*novastyl*

**OGO**



### **Nuance**

Discrète, texturée et craquelée, un filet souligné en porcelaine.



### **Omega**

Aile courte, simple, épuré et empilable. Porcelaine blanche résistante.

 **New products**  
Nouveautés



# 02

## VAISSELLE



Personnalisation vaisselle	84 à 85
OGO	88 à 103
ID Fine	104 à 111
Bonna	112 à 121
Novastyl	122 à 135
Porcelaine blanche	136 à 143
Pastas, Salades & Spécialités	144 à 146
Sarreguemines	147
Opal	148 à 151
Vaisselle verre et saladiers	152 à 154
Plats individuels	155
Ramequins et bols	156 à 157
Coupes à dessert	158 à 159
Mise en bouche	160 à 161
Service à thé et café	162 à 167
Tasses blanches et colorées	168 à 169
Photothèque vaisselle	170 à 173



**INTRODUCTION**

OGO Living développe des collections d'art de la table alliant design épuré, qualité durable et fonctionnalité.

**ÉLÉGANCE**

Pensée pour accompagner le quotidien des professionnels, la marque propose des produits fiables et contemporains qui subliment chaque service avec simplicité et élégance.

**ROBUSTESSE**

Offrant des produits à la fois modernes et intemporels, OGO Living est le choix parfait pour ceux qui recherchent qualité et style au quotidien.

**PRATICITÉ**



**JEU DE TEXTURES**

Porcelaine raffinée, mêlant harmonieusement textures, matières striées et finitions mates.



Compatible à l'utilisation du lave-vaisselle et du micro-ondes



**URUS**

Nous avons imaginé cette collection pour sublimer vos repas et transformer votre table en une véritable expérience gastronomique, digne des plus grands restaurants étoilés.

Fabriquée en porcelaine haut de gamme, cette collection se distingue par un subtil jeu de matières et de textures, combinant raffinement et modernité.

Son design unique s'inspire des formes délicates et organiques des oursins, que l'on retrouve dans les lignes des assiettes et des bols, apportant une touche naturelle et artistique à votre table.

# URUS

Collection by OGO

## La délicate porcelaine

La porcelaine est un matériau réputé dans la vaisselle, connue pour sa délicatesse et son raffinement. Malgré son apparence délicate, c'est en réalité un matériau très robuste et résistant, notamment à la chaleur et aux chocs légers, ce qui en fait un choix idéal pour une vaisselle quotidienne qui dure dans le temps.

La polyvalence de la porcelaine convient pour une variété d'utilisations, que ce soit pour des plats froids ou des plats chauds, passant du four à la table, mais également le micro-ondes et le lave-vaisselle.

Matériau non-poreux, la porcelaine n'absorbe pas les odeurs, les saveurs ou les bactéries, ce qui rend la vaisselle en porcelaine facile à nettoyer et hygiénique.



Porcelaine Qualité Hôtelière



Résistance aux chocs et aux rayures



Alliez élégance et sobriété avec une vaisselle subtilement ornée, conçue pour sublimer vos repas avec finesse.

## Un jeu de texture

Notre collection de vaisselle URUS met en valeur une esthétique raffinée et naturelle grâce à ses formes organiques et ses couleurs douces, mêlant le blanc pur au beige subtil.

Les assiettes, ainsi que les bols et tasses, s'inspirent des irrégularités délicates des oursins, conférant à chaque pièce une allure unique et sophistiquée.

Les lignes texturées et les reliefs légèrement striés évoquent les motifs naturels et irréguliers que l'on retrouve dans les coquilles d'oursins.

Ces éléments texturés ne sont pas simplement esthétiques, ils captent et reflètent la lumière de manière élégante, accentuant la finesse de la porcelaine utilisée.

Les teintes blanches et beiges apportent une touche de sobriété et d'élégance intemporelle, permettant à cette collection de se fondre harmonieusement dans n'importe quel style de table, tout en mettant en valeur les plats qu'elle accueille.

Parfaite pour dresser une table digne des plus grandes tables étoilées, cette collection marie avec brio simplicité organique et luxe contemporain.



Une collection bi-matière

Urus



Plate 28,5



Plate 28,5



Plate 31



Plate 31

Désignation	Coloris	Code	Ø x Ht cm	Sur.	Prix HT
Plate	Bleu	79 32 175	31 x 3,5	4	17,95
	Beige	79 32 190	31 x 3,5	4	17,95
	Bleu	79 32 176	28,5 x 3	4	14,95
	Beige	79 32 191	28,5 x 3	4	14,95



Creuse 110cl



Creuse 110cl



Gourmet 22cl



Gourmet 22cl

Désignation	Coloris	Code	Ø x Ht cm	Sur.	Prix HT
Creuse	Bleu	79 32 177	20 x 7	4	12,95
	Beige	79 32 192	20 x 7	4	12,95
Gourmet	Bleu	79 32 178	23 x 5,3	4	10,95
	Beige	79 32 193	23 x 5,3	4	10,95



# Urus



Désignation	Coloris	Code	Ccl	Φ x Ht cm	Sur.	Prix HT
Saucière	Bleu	79 32 179	10	6,5 x 5,5	8	4,50
	Beige	79 32 194	10	6,5 x 5,5	8	4,50
Bol	Bleu	79 32 184	10	8 x 4,5	12	3,95
	Beige	79 32 199	10	8 x 4,5	12	3,95
	Bleu	79 32 205	11	8 x 5	12	3,95
	Bleu	79 32 185	24	10 x 5,7	12	5,50
	Beige	79 32 200	24	10 x 5,7	12	5,50
	Bleu	79 32 206	80	18 x 5	4	12,95
	Beige	79 32 207	80	18 x 5	4	12,95



Désignation	Coloris	Code	Ccl	Φ x Ht cm	Sur.	Prix HT
Tasse	Bleu	79 32 182	21	9,2 x 6,5	6	5,50
	Beige	79 32 197	21	9,2 x 6,5	6	5,50
	Bleu	79 32 180	9	6,7 x 5,2	6	4,50
	Beige	79 32 195	9	6,7 x 5,2	6	4,50
Soucoupe	Bleu	79 32 183		15 x 1,8	6	4,50
	Beige	79 32 198		15 x 1,8	6	4,50
	Bleu	79 32 181		12 x 1,7	6	4,50
	Beige	79 32 196		12 x 1,7	8	4,50

**DESIGN ARTISANAL**

Apportez une touche d'authenticité à votre table avec notre gamme Ora. Alliant design artisanal et résistance professionnelle, elles sont idéales aussi bien pour les particuliers exigeants que pour les restaurateurs.



Résistance aux chocs et aux rayures

Porcelaine  
Qualité Hôtelière



Plate



Creuse

Désignation	Code	Ccl	Φ x Ht cm	Sur.	Prix HT
Plate	79 32 356		20,5 x 2,5	4	8,50
	79 32 355		27 x 3,3	4	12,50
Creuse	79 32 358	34	15,5 x 3,5	4	7,55
	79 32 357	66	21 x 4,5	4	11,65



Coupelle



Mug



Tasse

Désignation	Code	Ccl	Φ x Ht cm	Sur.	Prix HT
Coupelle	79 32 360	26	11,5 x 6	6	4,95
	79 32 359	57,5	15,5 x 7,5	4	7,95
Mug	79 32 362	32	9 x 10	4	5,95
Tasse	79 32 361	16	7,5 x 6,5	4	3,95



Plate

Ovale

Creuse

Coupe

Désignation	Code	Ccl	Φ x Ht cm	Sur.	Prix HT
Plate	79 32 367		23 x 3,5	4	9,95
	79 32 366		27,5 x 3,8	4	11,50
Ovale	79 32 365	41,5	23,5 x 15,5 x 4,5	4	9,95
Creuse	79 32 369	40	18 x 6,5	6	7,95
Coupe	79 32 368	66	20,5 x 5,4	4	10,95



Coupelle

Saucière

Désignation	Code	Ccl	Φ x Ht cm	Sur.	Prix HT
Coupelle	79 32 371	57,5	16 x 7,5	4	9,25
	79 32 370	7,5	7 x 4	12	2,95
Saucière	79 32 372	10	9 x 6,7 x 5,7	12	4,95

# Vénus

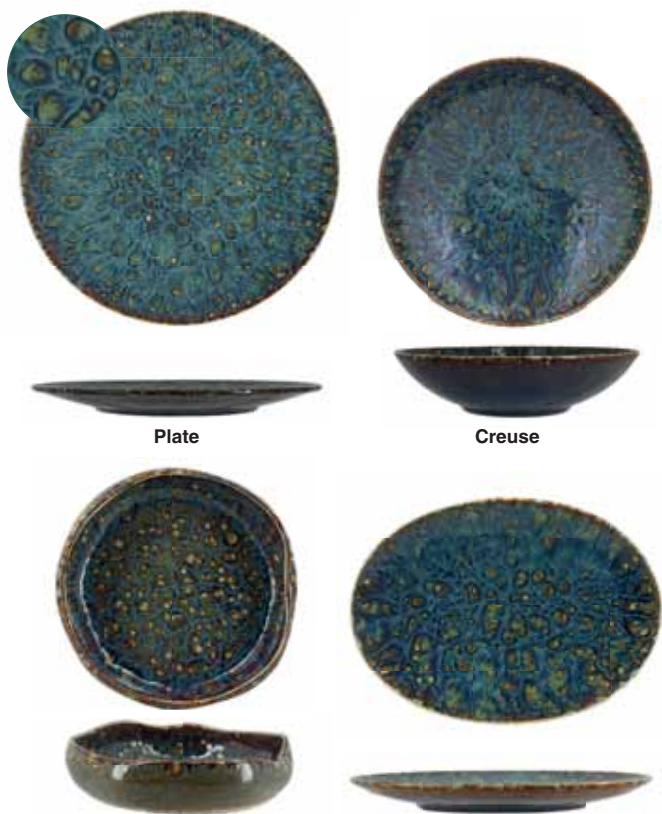

Plate

Creuse

Coupe

Ovale

Désignation	Code	Ccl	Φ x Ht cm	Sur.	Prix HT
Plate	79 32 212		20 x 2	6	4,50
	79 32 210		27 x 2	6	6,95
Creuse	79 32 211	92,4	21 x 5	6	5,25
Coupe	79 32 217	35	14 x 3,5	3	6,90
	79 32 218	190	19 x 4	2	9,90
	79 32 219	320	25 x 6,5	8	19,90
Ovale	79 32 213		21 x 17 x 2,5	3	6,25



Tasse

Sous Tasse

Bol

Coupelle

Désignation	Code	Ccl	Φ x Ht cm	Sur.	Prix HT
Tasse	79 32 215	17,5	7,5 x 6,5	12	2,65
Sous Tasse	79 32 216		14 x 2	6	2,35
Coupelle	79 32 208	24	13 x 6	6	5,90
	79 32 209	55	17 x 7,5	2	7,90
Bol	79 32 214	49	16 x 6	2	5,85



Résistance aux chocs et aux rayures

### DÉCOR

Émaux réactif, fusion harmonieuse des tons bleus et verts.



## Saturne



### TEXTURE

Sa conception en émail réactif rend chaque pièce unique.

Variations naturelles dans les teintes et les textures.



Cupelle 13



Plate 21



Creuse

Désignation	Code	Ccl	Φ x Ht cm	Sur.	Prix HT
Plate	79 32 297		21 x 2	6	4,50
	79 32 295		27 x 3	6	6,80
Creuse	79 32 296	92,4	21 x 5	6	5,60
Cupelle	79 32 298	24	13 x 6	6	6,00
	79 32 299	55	17 x 7,5	2	7,80
Plat rectangle	79 32 300		30 x 9,5 x 2	6	7,80



Plat rectangle



## Volcano **OGO**



Plate 27



Calotte



Plate 20



Bol



Plat rectangle

Désignation	Code	Φ x Ht cm	Sur.	Prix HT
Plat Rect	26 15 297	29,5 x 9,5 x 1,5	6	7,90
	26 15 298	46,5 x 10 x 1,5	6	11,06

Désignation	Code	Ccl	Φ x Ht cm	Sur.	Prix HT
Plate	26 15 296		20 x 2	6	4,39
	26 15 294		27 x 2	6	7,19
Calotte	26 15 295	80	21 x 5	6	5,52
Bol salade	26 15 299	55	16 x 5	2	6,15

Grès

Oli 

OGO



Plate 22

Plate 27,5



Coupe 15,3

Coupe 20,5

Désignation	Code	Ccl	Φ x Ht cm	Sur.	Prix HT
Plate	79 32 386		22 x 2	6	4,95
	79 32 385		27,5 x 3	6	6,11
Coupe	79 32 388	60	15,3 x 00	6	6,00
	79 32 387	100	20,5 x 7,8	4	12,75



Mug



Paire Tasse

Désignation	Code	Ccl	Φ x Ht cm	Sur.	Prix HT
Mug	79 32 389	38	8 x 9	6	4,31
Paire Tasse	79 32 390	22	8,3 x 6,2	6	5,55
Soucoupe/			14,7 x 2		



Résistance aux chocs et aux rayures

 New products  
Nouveautés



Plate 20,5

Plate 20,5

Désignation	Code	Ccl	Φ x Ht cm	Sur.	Prix HT
Plate	79 32 377		20,5 x 2,8	6	4,80
	79 32 376		21,5 x 3	6	4,80
	79 32 375		26,5 x 2,8	6	5,95



Résistance aux chocs et aux rayures



Coupelle 10cl

Coupelle 22cl

Désignation	Code	Ccl	Φ x Ht cm	Sur.	Prix HT
Coupelle	79 32 380	10	8,7 x 3	6	2,05
	79 32 379	22	12 x 4,7	6	2,80



Parme

Rose

Vert foncé

Désignation	Coloris	Code	Ccl	Φ x Ht cm	Sur.	Prix HT
Coupelle	Parme	79 32 378	32	16 x 5	6	5,20
	Rose	79 32 255	32	16 x 5	6	5,20
	Vert foncé	79 32 256	32	16 x 5	6	5,20



Vert clair

Bleu clair

Bleu foncé

Désignation	Coloris	Code	Ccl	Φ x Ht cm	Sur.	Prix HT
Coupelle	Vert clair	79 32 257	32	16 x 5	6	5,20
	Bleu clair	79 32 258	32	16 x 5	6	5,20
	Bleu foncé	79 32 259	32	16 x 5	6	5,20

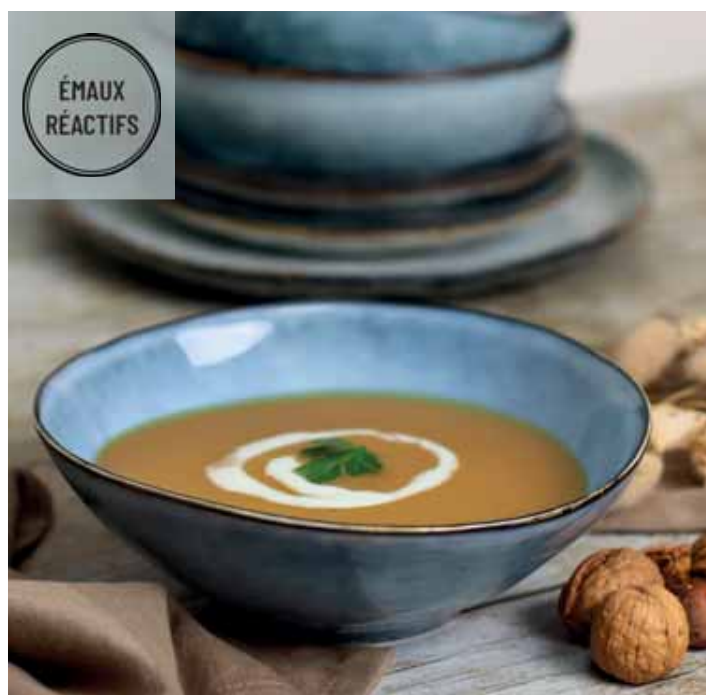
ÉMAUX  
RÉACTIFS

Plate



Coupe

Désignation	Code	Ccl	Φ x Ht cm	Sur.	Prix HT
Plate	79 32 077		20,5 x 2	6	4,85
	79 32 075		27,5 x 2,5	6	6,25
Coupe	79 32 078	100	20 x 5	4	6,25
	79 32 079	55	16 x 4,5	6	4,50



Saucière 8cl



Saucière 20cl



Mug

Désignation	Code	Ccl	Φ x Ht cm	Sur.	Prix HT
Saucière	79 32 160	8	5,3 x 6,2	6	3,25
	79 32 161	20	7 x 8,4	6	4,25
Mug	79 32 084	45	12,5 x 8,5 x 10,5	6	3,25



Coupelle 21cl



Bol 50cl



Pasta 20cl



Creuse 95cl



Coupelle 100cl

Désignation	Code	Ccl	Φ x Ht cm	Sur.	Prix HT
Coupelle	79 32 244	21	12 x 8 x 4	6	3,95
Creuse	79 32 242	95	21 x 7	4	6,25
Bol	79 32 243	50	17 x 6	6	4,95
Pasta	79 32 240	20	27 x 6,5	4	14,95
Coupelle	79 32 076	100	20 x 7	6	5,75



Plate 20,5



Plate 27,5



Creuse



Désignation	Code	Φ x Ht cm	Sur.	Prix HT
Plate	79 32 073	20,5 x 2	12	4,85
	79 32 070	27,5 x 2,5	6	6,25
Creuse	79 32 252	21 x 19,8	4	6,25



**TEXTURE**

Céramique émaux réactifs ton pierre : chaque pièce est unique et différente.

Finition brillante.

Sous face émaillée.



Coupelle 21cl



Saucière 8cl



Saucière 20cl



Coupe



Bol 50cl



Désignation	Code	Ccl	Φ x Ht cm	Sur.	Prix HT
Saucière	79 32 166	20	7 x 8,4	6	4,25
Bol	79 32 253	50	17 x 6	6	4,95
Coupelle	79 32 254	21	12 x 8	6	3,95
Coupe	79 32 071	100	20 x 5	4	6,25
	79 32 072	55	16 x 4,5	6	4,50

## Katanga



Plate 27,5



Plate 20,5



## TEXTURE

Création unique chaque pièce est décorée à la main.

Design sophistiqué de qualité supérieure.



Coupelle



Désignation	Code	Ccl	Φ x Ht cm	Sur.	Prix HT
Plate	79 32 116		20,5 x 1,5	6	4,85
	79 32 115		27,5 x 2,5	6	6,25
Coupelle	79 32 117	100	20 x 7	6	6,25

## Grenada



Plate 27,5



Plate 20,5



Coupe 100cl



Bol 50cl



Coupelle 21cl

Désignation	Code	Ccl	Φ x Ht cm	Sur.	Prix HT
Plate	79 32 121		20,5 x 2	24	4,85
	79 32 120		27,5 x 2,5	12	6,25

Désignation	Code	Ccl	Φ x Ht cm	Sur.	Prix HT
Coupe	79 32 122	100	20 x 5	16	6,25
Bol	79 32 263	50	17 x 6	6	4,95
Coupelle	79 32 264	21	12 x 8 x 4	6	3,95



ORA

New collection by OGO

Alliant design artisanal et résistance professionnelle.

**OGO**  
LIFE



**ÉLÉGANCE DISCRÈTE**

Grâce à son blanc pur, notre gamme apporte une touche d'élégance discrète qui s'adapte à toutes les ambiances.

Son design épuré traverse les tendances et convient à tous les styles de table. Elle s'intègre parfaitement dans tous les types de décorations de table, qu'elles soient modernes, classiques ou minimalistes.

Parfaitement empilable



Résistance aux chocs et aux rayures



Porcelaine  
Qualité Hôtelière



Plate



Creuse

Désignation	Code	Φ x Ht cm	Sur.	Prix HT
Plate	79 32 322	18 x 2,3	6	1,65
	79 32 317	20 x 2,5	12	2,00
	79 32 316	22 x 2,7	6	2,54
	79 32 315	24,5 x 3	12	2,73

Désignation	Code	Ccl	Φ x Ht cm	Sur.	Prix HT
Creuse	79 32 321	12	13,5 x 2	12	2,19
	79 32 320	18	15 x 2,5	12	2,63
	79 32 319	40	20 x 3,8	12	3,17
	79 32 318	55	22 x 4	12	3,36

**Thera** 



Plate 30,5

Plate 28



Plate 24

Plate 19

Désignation	Code	Φ x Ht cm	Sur.	Prix HT
Plate	79 32 305	30,5 x 3	6	5,95
	79 32 306	28 x 3	6	3,75
	79 32 307	26,5 x 2,5	6	3,30
	79 32 308	24 x 2,5	6	2,55
	79 32 309	22,5 x 2,5	6	2,35
	79 32 310	21 x 2,5	6	2,10
	79 32 311	19 x 2,2	6	1,95



Dessert

Creuse

Désignation	Code	Ccl	Φ x Ht cm	Sur.	Prix HT
Dessert	79 32 314		16 x 2	6	1,75
	79 32 312		14 x 1,8	6	1,65
Creuse	79 32 313	40	23 x 4	6	2,45

 **New products**  
Nouveautés

**DESIGN ÉPURÉ**



Son design épuré traverse les tendances et convient à tous les styles de table, puisqu'elle s'intègre parfaitement dans tous les types de décorations de table, qu'elles soient modernes, classiques ou minimalistes.

Sa simplicité met en valeur les plats sans jamais détourner l'attention.



Résistance aux chocs et aux rayures



Porcelaine  
Qualité Hôtelière



**INTRODUCTION**

ID Fine conçoit des collections de porcelaine pensées pour les professionnels, où l'élégance du design rencontre l'exigence de la fonctionnalité et de la durabilité.

**RÉSISTANCE**

Portée par le concept Sustainable Harmony, la marque développe des collections compatibles entre elles dans le temps. Cette approche unique permet de faire évoluer les mises en scène et les présentations sans avoir à renouveler les stocks existants, dans une logique responsable et maîtrisée.

**ROBUSTESSE**

ID Fine accompagne ainsi les chefs et les acteurs de l'hôtellerie-restauration avec une vision créative, cohérente et performante, conçue pour répondre aux exigences d'aujourd'hui tout en s'inscrivant dans le long terme.

**DURABILITÉ**



**Delta**

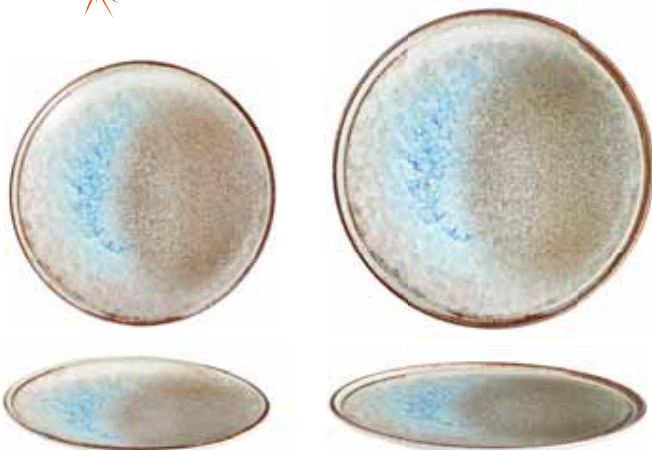

Plate 23

Pizza 31



Coupelle

Bol

Désignation	Code	Φ x Ht cm	Sur.	Prix HT
Plate	25 14 145	15 x 1,8	12	4,53
	25 14 146	17 x 1,9	12	5,12
	25 14 147	19 x 2,2	12	5,96
	25 14 148	21 x 2,2	12	6,64
	25 14 149	23 x 2,3	12	7,58
	25 14 150	25 x 2,5	12	8,43
	25 14 151	27 x 2,7	12	9,03
	25 14 152	28,5 x 2,6	12	10,83
	25 14 153	30 x 3,1	12	12,93
Pizza	25 14 162	31 x 1,6	6	13,75

Désignation	Code	Ccl	Φ x Ht cm	Sur.	Prix HT
Coupelle	25 14 156	6	10 x 2,4	24	3,06
	25 14 157	24	15 x 3	12	5,19
	25 14 201	9	10 x 3,6	24	3,22
Bol	25 14 202	42	16 x 5,3	12	6,21
	25 14 203	62	18 x 5,9	6	8,23

Delta 



Ovale 33x21



Ravier 12x8



Rectangle 22x10



Rectangle 27x20

Désignation	Code	Φ x Ht cm	Sur.	Prix HT
Ovale	25 14 171	14 x 9 x 2,4	12	9,11
	25 14 172	18 x 12 x 2,4	12	10,11
	25 14 173	23 x 15 x 2,7	12	12,13
	25 14 174	28 x 18 x 3	6	14,48
	25 14 175	33 x 21 x 3	6	16,00
	25 14 176	37 x 24 x 3	6	17,78

Désignation	Code	Ccl	L x l x Ht cm	Sur.	Prix HT
Ravier	25 14 185	4,5	10 x 7 x 2,2	12	6,01
	25 14 186	10,5	12 x 8 x 2,9	12	7,83
	25 14 187	18	14 x 10 x 3,2	12	9,15
	25 14 188	35	17 x 12 x 4	12	11,40
Rectangle	25 14 195		22 x 10 x 2,2	12	11,71
	25 14 191		27 x 20 x 2,3	6	20,78



Creuse



RÉSISTANCE DES COULEURS

Chaque pièce offre un effet réactif unique, pour un design original et distinctif.

Porcelaine fine au design moderne



Résistance aux chocs et aux ébrèchures



Pasta 28

Pasta 29

Désignation	Code	Ccl	Φ x Ht cm	Sur.	Prix HT
Creuse	25 14 158	55	20 x 3,8	12	6,67
	25 14 159	77	22 x 4,3	12	10,52
	25 14 160	110	25 x 4,5	12	13,54
Pasta	25 14 165	17	20 x 3,5	12	8,14
	25 14 166	42	25 x 5,4	12	11,35
	25 14 167	56	28 x 5,8	6	12,91
	25 14 168	46	29 x 5,8	6	16,18



 New products  
Nouveautés

ÉMAUX  
RÉACTIFS



Résistance aux chocs et aux ébréchantures



Pizza



Plat ovale



Plat rectangle



Plate 30



Creuse 20

Désignation	Code	Ccl	Φ x Ht cm	Sur.	Prix HT
Plate	25 14 217		15 x 1,8	12	5,75
	25 14 228		16,5 x 2,2	12	6,81
	25 14 219		19 x 2,2	12	7,10
	25 14 229		21 x 2,1	6	9,75
	25 14 222		25 x 2,5	12	9,96
	25 14 230		25,5 x 2,3	6	12,33
	25 14 223		27 x 2,7	12	11,71
	25 14 231		28 x 2,4	6	13,01
	25 14 225		30 x 3	6	15,82
Creuse	25 14 241	55	20 x 3,8	12	10,37
	25 14 243	114	25 x 4,5	12	14,45



Coupelle 46cl



Bol 42cl

Désignation	Code	Ccl	Φ x Ht cm	Sur.	Prix HT
Pizza	25 14 246		31 x 1,6	6	17,42
Plat Ovale	25 14 252		23 x 15 x 2,7	12	16,07
Plat rectangle	25 14 271		27 x 20 x 2,3	6	23,68

Désignation	Code	Ccl	Φ x Ht cm	Sur.	Prix HT
Coupelle	25 14 281	15	10 x 3,6	12	5,17
	25 14 282	46	14 x 5,3	12	9,55
Bol	25 14 288	9	10 x 3,6	24	4,71
	25 14 289	42	16 x 5,3	12	9,09

# MELLOW

New collection by ID Fine



Glaçure verte réactive qui offre un aspect unique à chaque pièce

 ID Fine





Plate 27

Pizza

Désignation	Code	Ccl	Φ x Ht cm	Sur.	Prix HT
Plate	25 14 560		15 x 1,8	12	6,05
	25 14 563		21 x 2,2	12	8,25
	25 14 565		25 x 2,5	12	10,48
	25 14 566		27 x 2,7	12	11,66
	25 14 568		30 x 3	6	16,66
Pizza	25 14 579		31 x 1,6	6	18,33



Coupe 62cl

Creuse 77cl



Plat ovale

Pasta

Désignation	Code	Ccl	Φ x Ht cm	Sur.	Prix HT
Coupe	25 14 655	62	18,5 x 3,9	12	9,66
Creuse	25 14 586	77	22 x 4,3	12	13,64
Plat ovale	25 14 611		26 x 2,1	12	11,83
	25 14 612		32 x 2,3	6	15,96
Pasta	25 14 592	42	25 x 5,4	12	13,21



Assiette ovale

Plat rectangle

Désignation	Code	Ccl	Φ x Ht cm	Sur.	Prix HT
Ass. ovale	25 14 601		23 x 15 x 2,7	12	16,92
	25 14 602		28 x 18 x 3	6	18,80
Plat rectangle	25 14 623		27 x 20 x 2,3	6	24,93



Coupelle 9cl

Coupelle 21cl

Coupelle 46cl



Bol 38cl

Bol 52cl

Bol 42cl

Désignation	Code	Ccl	Φ x Ht cm	Sur.	Prix HT
Coupelle	25 14 644	9	10 x 3,6	24	4,96
	25 14 665	21	10 x 5,7	12	6,69
	25 14 636	46	14 x 5,3	12	10,05
Bol	25 14 654	38	13,5 x 4,9	12	8,95
	25 14 666	52	14 x 6,6	6	10,05
	25 14 645	42	16 x 5,3	12	9,57



Expresso 8cl

Mug 26cl

Café 20cl

Soucoupe

Désignation	Code	Ccl	Φ x Ht cm	Sur.	Prix HT
Mug	25 14 689	26	8,3 x 9	6	7,26
Expresso	25 14 673	8	6,4 x 5,7	12	5,68
Soucoupe	25 14 672		12 x 1,7	12	4,01
Café	25 14 675	20	8,5 x 6,7	12	7,35
Soucoupe	25 14 674		12 x 1,7	12	4,01



Porcelaine

Tiffany 

Résistance aux chocs et aux ébréchantures



ID Fine



Plate 25

Creuse

Désignation	Code	Ccl	Φ x Ht cm	Sur.	Prix HT
Plate	25 14 715		20 x 1,9	12	4,51
	25 14 716		25 x 2,3	12	6,93
	25 14 717		29 x 2,8	6	9,10
Creuse	25 14 723	33	22 x 3,5	12	8,24



Plat ovale 22x00

Coupelle



Plat ovale 32x00

Saladier

Désignation	Code	Ccl	Φ x Ht cm	Sur.	Prix HT
Plat ovale	25 14 727		21 x 2,7	12	10,22
	25 14 731		22 x 2,6	12	6,14
	25 14 728		26 x 2,9	6	12,30
	25 14 729		32 x 3,5	6	14,01
Coupelle	25 14 735	8	11 x 3,7	12	2,99
	25 14 736	20	16 x 4,6	12	5,77
	25 14 737	45	18 x 5,8	6	7,48
Saladier	25 14 738	92	26 x 6,3	6	8,26



Tasse à thé



Sous-tasse

Désignation	Code	Ccl	Φ x Ht cm	Sur.	Prix HT
Tasse à Thé	25 14 744	18	7,9 x 7	12	4,30
Sous-tasse	25 14 746		12 x 2,4	12	2,44
	25 14 745		16 x 1,9	12	3,03

Modest 



Plate 21 - Noir

Plate 21 - Vert

Désignation	Code	Coloris	Ccl	Φ x Ht cm	Sur.	Prix HT
Plate	25 14 331	Noir		15 x 1,8	12	4,09
	25 14 334	Noir		21 x 2,2	12	5,54
	25 14 336	Noir		25 x 2,5	12	7,08
	25 14 337	Noir		27 x 2,7	12	7,87
	25 14 339	Noir		30 x 3,1	6	11,25
	25 14 454	Vert		21 x 2,1	6	6,67
	25 14 455	Vert		25,5 x 2,3	6	8,44
	25 14 456	Vert		28 x 2,4	6	9,38



Résistance aux chocs et aux ébrèchures



Pizza - Noir

Pasta - Noir

Désignation	Code	Coloris	Ccl	Φ x Ht cm	Sur.	Prix HT
Pizza	25 14 365	Noir		31 x 1,6	6	12,38
Pasta	25 14 370	Noir	147	20 x 3,5	12	7,56
	25 14 371	Noir	45	25 x 5,4	12	10,78



Creuse - Noir

Coupe - Vert



Assiette Ovale - Vert

Plat Ovale - Vert

Désignation	Code	Coloris	Ccl	Φ x Ht cm	Sur.	Prix HT
Creuse	25 14 359	Noir	77	22 x 4,3	12	9,21
Coupe	25 14 497	Vert		17 x 5,4	6	8,69
	25 14 498	Vert		21 x 5,5	6	10,17
Coupelle	25 14 495	Vert	15	10 x 3,6	12	3,68
Ass. Ovale	25 14 486	Vert		28 x 18 x 3	6	14,10
Plat Ovale	25 14 487	Vert		33 x 21 x 3	6	15,67

 New products  
Nouveautés

bonna

**INTRODUCTION**

Bonna est la marque de porcelaine hôtelière haut de gamme, conçue pour un usage intensif.

**RÉSISTANCE**

Combinant résistance, design contemporain et continuité de gamme.

**ESTHÉTISME**

Style premium, finitions maîtrisées, réassort fiable : une solution solide pour les restaurants qui veulent une table esthétique, durable et cohérente.

**DURABILITÉ**

3 fois moins de renouvellement grâce à la garantie ébréchure.

VAISSELLE



**Lagoon Ocean** 



Plate 26

Plate 15

Désignation	Code	Φ x Ht cm	Sur.	Prix HT
Plate	26 33 300	15 x 1,5	12	5,14
	26 33 301	18 x 1,5	6	8,34
	26 33 302	22 x 1,5	6	12,22
	26 33 303	26 x 1,5	4	14,44

Lagoon Ocean 

Creuse

Bol

Désignation	Code	Ccl	Φ x Ht cm	Sur.	Prix HT
Creuse	26 33 305	30	17 x 4,5	6	9,73
	26 33 306	60	21 x 6	6	16,76
	26 33 307	130	26 x 7,5	6	22,68
Bol	26 33 312	45	22 x 7	2	22,15



Ovale

Désignation	Code	Ccl	L x l x Ht cm	Sur.	Prix HT
Ovale	26 33 309	65	27 x 16 x 5	4	14,01
	26 33 310	95	31 x 20 x 5,5	3	17,99



## PORCELAINE

Chaque pièce se distingue par un mélange harmonieux de tons bleu profond et sable, rappelant les courants marins et les fonds marins.

Parfaite pour créer une ambiance sophistiquée et apaisante, cette collection transforme chaque repas en une expérience mémorable.





Digital Printing



Plate

Creuse

Désignation	Code	Φ x Ht cm	Sur.	Prix HT
Plate	26 32 648	30 x 2	6	11,97
	26 32 655	27 x 2	12	8,35
	26 32 653	21 x 2,5	12	6,14
Dessert	26 32 649	17 x 2	12	4,73
Creuse	26 32 654	25 x 2,5	6	12,55
	26 32 658	23 x 4,5	6	10,45



Pasta

Pizza\*

Désignation	Code	Ccl	Φ x Ht cm	Sur.	Prix HT
Pasta	26 32 659		27 x 4,5	6	13,13
Pizza	26 32 665*		32 x 2	6	14,65



Moove

Ovale

Désignation	Code	Φ x Ht cm	Sur.	Prix HT
Moove	26 32 652	34 x 16	12	22,58
	26 32 651	23 x 16	12	14,28
Ovale	26 32 650	31 x 24	6	13,60



**PORCELAINE**

Finesse de la porcelaine au délicat motif inspiré du palais de l'Alhambra qui allie culture orientale et élégance.

Résistance aux chocs et aux rayures.



Edge chip warranty

Résistant contre les ébréchures

\*Out of warranty / Non compris.



Plate Ø22



Plate Ø18



Creuse



Ovale

Désignation	Code	Ccl	Φ x Ht cm	Sur.	Prix HT
Plate	26 33 318		18 x 1,9	12	3,31
	26 33 319		22 x 2,2	12	4,30
	26 33 320		24 x 2	12	4,92
	26 33 321		28 x 2,4	6	6,08
	26 33 322		30 x 1,9	6	8,34
Creuse	26 33 323*	30	23 x 3,5	6	6,96
	26 33 324*	46	27 x 5	6	9,33
	26 33 325*	40	28 x 5,2	6	9,88
	26 33 326*		22 x 14 x 1,8	6	4,81
Ovale	26 33 327*		28 x 18 x 2	6	6,41
	26 33 328*		32 x 21 x 2	6	8,12

**ÉLÉGANCE & SIMPLICITÉ**

Chaque pièce est soigneusement conçue avec des lignes uniques qui embrassent délicatement les assiettes, leur offrant une liberté esthétique sans limite.

Parées de tons doux et blancs, les pièces Albus présentent une forme douce, sans angles vifs, apportant une touche distinctive aux créations des chefs.



Résistance aux chocs et aux rayures



 Edge chip warranty  
Résistant contre les ébrèchures

\*Out of warranty / Non compris.

 New products  
Nouveautés

Porcelaine  
**East White** 

**bonna**



Plate





Creuse

Désignation	Code	Ccl	Φ x Ht cm	Sur.	Prix HT
Plate	26 33 102		21 x 2	12	5,30
	26 33 103		25 x 2,5	12	5,89
	26 33 104		27 x 2,6	12	8,35
Creuse	26 33 106	60	25 x 4,5	6	8,93



**RÉSISTANT**

Les assiettes en porcelaine blanche de la gamme EAST mettront en valeur vos plats et apporteront une touche d'élégance sur votre table à toute occasion.

Résistance aux chocs et aux rayures



Coupelle

Bol

Désignation	Code	Ccl	Φ x Ht cm	Sur.	Prix HT
Coupelle	26 33 109	13	11 x 10 x 3,3	12	3,52
Bol	26 33 110	40	16 x 5,6	12	4,96

 **New products**  
 Nouveautés



Plate Hygge



Dessert Hygge



Ovale Hygge



Plate et Dessert Gourmet

Désignation	Code	Φ x Ht cm	Sur.	Prix HT
Plate Hygge	26 32 834*	22 x 2	6	9,61
Dessert Hygge	26 32 826*	16 x 2	12	6,72
Ovale Hygge	26 32 830*	34 x 23 x 2	6	22,58
Plate Gourmet	26 32 832	27 x 2	12	8,35
Plate Gourmet	26 32 828	21 x 2	12	7,09
Dessert Gourmet	26 32 827	17 x 2	12	4,73



Pizza



Pasta

Désignation	Code	Φ x Ht cm	Sur.	Prix HT
Pizza	26 32 835*	32 x 1,1	6	14,65
Pasta	26 32 838*	27 x 5,7	6	13,13



Creuse



Bol Vago

Désignation	Code	Ccl	Φ x Ht cm	Sur.	Prix HT
Creuse	26 32 837	130	25 x 4,5	6	14,54
	26 32 836	100	23 x 4,5	6	10,45
Bol Vago	26 32 842*	47	18 x 5,5	12	10,70



Rectangle 01

Rectangle 02

Vago

Désignation	Code	Ccl	Φ x Ht cm	Sur.	Prix HT
Rectangle 01	26 32 840		23 x 16	12	16,49
Rectangle 02	26 32 841		34 x 16	12	26,14
Vago	26 32 831		36 x 17 x 1	12	19,43



**DÉCOR**

Toute l'essence de la région méditerranéenne s'étend vers le bleu et tous les vents portent les arômes invitants les saveurs exquises.

Les motifs de couleur bleu méditerranéen sont dessinés à la main individuellement. Texture originale de l'inspiration à l'arrière plan de Viento.

Cette collection est devenu le symbole élaboré d'un été sans fin sur la table.



Edge chip warranty

Résistant contre les ébréchantures

\*Out of warranty / Non compris.

Porcelaine

# Luca Mozaic

bonna 

VAISSELLE



## DÉCOR

Inspirés de pièces mosaïque.

Collection audacieuse et affirmée, pour ceux qui cherche un design qui accompagne l'harmonie des différentes saveurs qu'ils réunissent dans l'assiette.



Digital Printing



### Plate

### Creuse 100 cl

Désignation	Code	Ccl	Φ x Ht cm	Sur.	Prix HT
Plate	26 32 689		21 x 2	12	6,72
	26 32 690		27 x 2	6	8,35
Creuse	26 32 692	100	23 x 4,5	6	10,45



### Bol

### Pizza

### Pasta 40 cl

Désignation	Code	Ccl	Φ x Ht cm	Sur.	Prix HT
Pizza	26 32 691*		32 x 2	6	13,95
Pasta	26 32 695	40	28 x 4,5	6	15,54
Bol	26 32 698	40	16 x 7	12	7,77



Résistance aux chocs et aux rayures

## Lunar Océan



Digital Printing



Plate Hygge

Pasta Hygge

Désignation	Code	Ccl	Φ x Ht cm	Sur.	Prix HT
Plate hygge	26 32 101		16 x 2	12	7,03
	26 32 102		22 x 1,7	6	10,03
	26 32 103		28 x 1,8	6	14,18
Pasta hygge	26 32 105	90	28 x 5,9	6	19,79

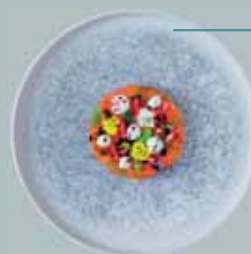

## TEXTURE

Originale avec ses options de couleurs pastels.

Cette collection apporte une touche innovante sur les tables, avec une application spéciale d'émail complétée par la technologie Envisio Engraved.



Petite coupelle

Grande coupelle

Désignation	Code	Ccl	Φ x Ht cm	Sur.	Prix HT
Coupelle	26 32 110	12	10 x 2,3	12	4,41
	26 32 111	45	14 x 5	12	7,93

## Grès vitrifié

# Hornfels

bonna



Plate

Creuse

Désignation	Code	Ccl	Φ x Ht cm	Sur.	Prix HT
Plate	26 32 948		16 x 2	12	6,41
	26 32 949		21 x 2	6	8,76
	26 32 950		26 x 2	6	10,87
	26 32 951		28 x 2	6	11,91
Creuse	26 32 952*	35	19 x 5	6	9,24
	26 32 953*	100	26 x 7	6	13,59



Creuse

Désignation	Code	Ccl	Φ x Ht cm	Sur.	Prix HT
Cupelle	26 32 954*	3,5	6 x 2,5	12	2,63
	26 32 955*	7	8 x 3	12	3,10
	26 32 956*	41,5	13 x 5	12	6,72
Bol	26 32 944	100	18,5 x 6	6	9,00



### DÉCOR VOLCANIQUE

Hornfels, une collection inspirée des plages de sable volcanique noir et des colonnes de basalte, offre des couleurs terreuses saisissantes.

Fabriquée en grès de haute qualité, elle allie durabilité et élégance pour une expérience culinaire exceptionnelle.



Vaisselle compatible lave-vaisselle et micro-ondes



Résistance aux chocs et aux rayures



Assiette café



Mug



Tasse

Désignation	Code	Ccl	L x l x Ht cm	Sur.	Prix HT
Assiette Café	26 32 960*		20 x 17 x 1	12	6,77
Tasse	26 32 957*	10	8,5 x 6 x 5	6	3,98
	26 32 958*	20,5	12,5 x 9,5 x 6	6	5,83
Mug	26 32 959*	32	12 x 8,5 x 9	12	6,56



Edge chip warranty

Résistant contre les ébréchantures

\*Out of warranty / Non compris.

# Aura Space

Porcelaine

**bonna**



Plate

Bol

Coupelle

Désignation	Code	Ccl	Φ x Ht cm	Sur.	Prix HT
Plate	26 32 508		21 x 2	12	7,45
	26 32 476		23 x 2	12	8,56
	26 32 477		25 x 2	12	9,30
	26 32 509		27 x 2	12	9,97
Bol	26 32 485	40	16 x 5,5	12	8,35
Coupelle	26 32 487	29	12 x 5	24	7,30



**SPIRALE ARTISTIQUE**

Les assiettes Aura, en porcelaine peinte à la main, captivent avec leur palette de trois coloris envoûtants : Terrain, Space et Passion. Leur effet peinture spirale ajoute une dimension artistique à chaque repas.



Peint à la main





Résistance aux chocs et aux rayures



Compatible lave-vaisselle et micro-ondes

# Aura Passion



 Edge chip warranty  
Résistant contre les ébréchantures | \*Out of warranty / Non compris.



Plate

Creuse

Pasta

Bol

Coupelle

Coupelle

Désignation	Code	Ccl	Φ x Ht cm	Sur.	Prix HT
Plate	26 32 578		17 x 2	12	5,78
	26 32 579		21 x 2	12	7,45
	26 32 583		25 x 2	12	9,30
	26 32 582		27 x 2,5	12	9,97
Creuse	26 32 574	100	23 x 4,5	6	11,71

Désignation	Code	Ccl	Φ x Ht cm	Sur.	Prix HT
Pasta	26 32 575	40	24 x 5,5	6	12,76
	26 32 576	40	27 x 5,5	6	15,86
Bol	26 32 586	40	16 x 5,5	12	7,95
Coupelle	26 32 571	29	12 x 5	24	7,30
	26 32 587	6	8 x 3 x 4,5	24	5,57



novastyl

**INTRODUCTION**

Novastyl propose des collections d'art de la table destinées aux professionnels de l'hôtellerie, de la restauration et des collectivités, en mettant l'accent sur la fonctionnalité et la résistance.

**RÉSISTANCE**

Pensés pour un usage intensif, les produits Novastyl accompagnent le quotidien des établissements avec des solutions pratiques, fiables et faciles à intégrer à tous les styles de service.

**PRATIQUE**

Sobres et efficaces, les collections Novastyl répondent aux besoins essentiels des professionnels tout en apportant une touche actuelle à la table.

**EFFICACE**

novastyl



**Atome**



Plate 25

Creuse

Désignation	Code	Ccl	Φ x Ht cm	Sur.	Prix HT
Plate	25 13 472		19 x 2,5	12	2,95
	25 13 470		25 x 3,7	12	3,95
Creuse	25 13 471	70	20,5 x 5,7	12	2,95

**QUALITÉ**

En faïence apporte une touche d'élégance et d'authenticité à votre table.

Robuste et facile à entretenir, elle est parfaite pour sublimer vos repas au quotidien.



Résistance aux chocs et aux rayures



**New products**  
Nouveautés

Nuance 



Plate 20



Ovale



**TEXTURE**

Sa texture craquelée confère à chaque pièce un caractère unique.

Son design intemporel en font un choix parfait pour votre table tout en gardant une touche naturelle et minimaliste.



Résistance aux chocs et aux rayures



Creuse



Cupelle

Désignation	Code	Ccl	Φ x Ht cm	Sur.	Prix HT
Plate	26 15 737		20 x 2	6	3,95
	26 15 735		27 x 2	6	5,95
Ovale	26 15 738		19 x 10,8 x 3	6	4,15
	26 15 739		23,5 x 13,5 x 3	6	4,95

Désignation	Code	Ccl	Φ x Ht cm	Sur.	Prix HT
Creuse	26 15 736	100	21 x 5	6	4,75
Cupelle	26 15 744	35	15,5 x 5,5	6	3,25

Porcelaine

## Palmeraie

novastyl



Plate 27

Creuse

Ovale

Tasse et soucoupe



Résistance aux chocs et aux rayures



Désignation	Code	Ccl	Φ x Ht cm	Sur.	Prix HT
Plate	26 15 797		21 x 2	24	4,20
	26 15 795		27 x 2	6	5,45
Creuse	26 15 796		21 x 5	6	4,50
Ovale	26 15 798		24 x 17	4	4,75
Bol	26 15 806	49	16 x 6	2	4,75
Tasse	26 15 807	16	8 x 6	12	2,75
Soucoupe	26 15 808		13 x 2,5	12	1,80

## Spirale



### QUALITÉ

En faïence au motif de cercles bleus apporte une touche d'élégance et d'authenticité à votre table.

Robuste et facile à entretenir, elle est parfaite pour sublimer vos repas au quotidien.



Plate 27

Creuse

Désignation	Code	Ccl	Φ x Ht cm	Sur.	Prix HT
Plate	25 13 467		21 x 2,4	12	3,95
	25 13 465		27 x 2,6	12	5,95
Creuse	25 13 466	75	22 x 4,8	12	5,95



 New products  
Nouveautés

## Botanic



### DÉCOR

Apportez la douceur de la nature à votre table avec ce décor fleuri et délicatement orné d'oiseaux.



Plate 26



Creuse



Plate 21



Désignation	Code	Ccl	Φ x Ht cm	Sur.	Prix HT
Plate	26 15 522		21 x 1,5	6	4,06
	26 15 520		26 x 2,5	6	5,40
Creuse	26 15 521	80	21 x 5,5	6	4,48

## Maka



novastyl



Plate 27



Calotte



Plate 21



Coupelle



Résistance aux chocs et aux rayures



Désignation	Code	Ccl	Φ x Ht cm	Sur.	Prix HT
Plate	26 15 107		21 x 1,5	6	4,69
	26 15 105		27 x 2,5	6	5,89
Calotte	26 15 106	80	21 x 5,5	6	4,81
Grande calotte	26 15 108	110	26 x 4,5	6	6,56
Coupelle	26 15 109	18	10 x 4,5	6	3,04
	26 15 110	35	12 x 5	6	3,88
	26 15 111	55	16 x 6	6	5,41

## Byzance



Coupelle



Mini Tajine



Plate



Creuse

Désignation	Code	Ccl	Φ x Ht cm	Sur.	Prix HT
Plate	26 15 402		20 x 2	6	4,07
	26 15 400		27 x 2	6	5,20
Creuse	26 15 401	80	21 x 5	6	4,38
Ovale	26 15 403		18,5 x 10,5 x 3	4	6,13
Coupelle	26 15 404	35	12 x 5	6	5,92
Mini Tajine	26 15 415	11,1	14,5 x 10	1	6,39
Tajine	26 15 416	88,1	24,5 x 15,5	1	14,63



## Lachat



Plate 26



Plate 21



Calotte



Coupelle

Désignation	Code	Ccl	Φ x Ht cm	Sur.	Prix HT
Plate	26 34 010		26 x 2	6	5,41
	26 34 012		21 x 2	6	4,36

Désignation	Code	Ccl	Φ x Ht cm	Sur.	Prix HT
Calotte	26 34 011	60	21 x 4	6	4,20
Coupelle	26 34 013	40	14 x 5	6	3,83

## Natura



### INSPIRATION NATURE

Assiettes aux teintes éclatantes, inspirées de la nature, avec une texture mosaïque évoquant la croûte terrestre. Une gamme aux coloris captivants allant du cuivré irisé aux teintes bleutées.



Résistance aux chocs et aux rayures



Plate 26



Plate 21



Creuse



Coupelle

Désignation	Code	Φ x Ht cm	Sur.	Prix HT
Plate	26 34 017	21 x 2,5	6	4,75
	26 34 015	26 x 2,5	6	5,75

Désignation	Code	Ccl	Φ x Ht cm	Sur.	Prix HT
Creuse	26 34 016		21 x 4	6	4,75
Coupelle	26 34 019		23 x 5	6	5,60
	26 34 018		14 x 5,4	6	3,40

Jasmin

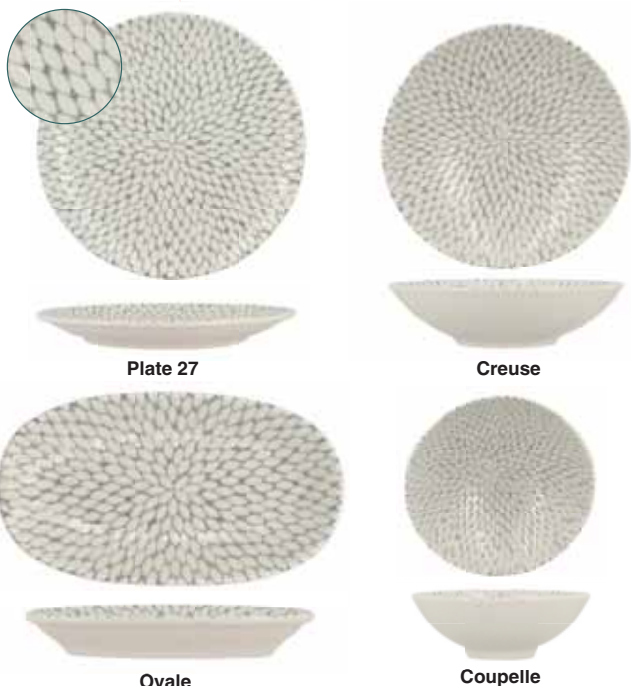

Désignation	Code	Ccl	Φ x Ht cm	Sur.	Prix HT
Plate	26 15 707		20 x 2	6	3,95
	26 15 705		27 x 2	6	5,95
Creuse	26 15 706	80	21 x 5	6	4,75
Ovale	26 15 708		19 x 10 x 3	6	5,15
	26 15 709		23,5 x 13 x 3	6	4,95
Coupelle	26 15 713	35	15 x 5	6	3,25

INSPIRATION NATURE

Son motif délicat, inspiré des pétales finement entrelacés, crée un effet visuel tout en finesse.



Résistance aux chocs

Aqua

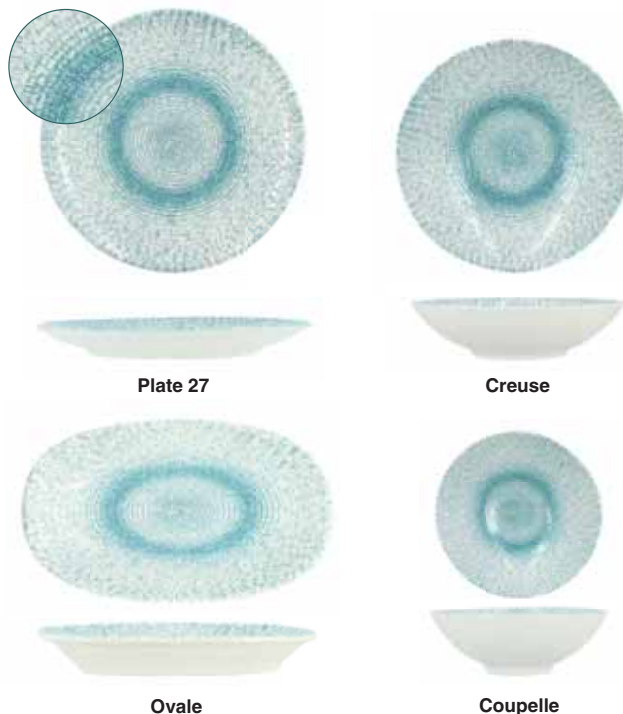

Désignation	Code	Ccl	Φ x Ht cm	Sur.	Prix HT
Plate	26 15 717		20 x 2	6	4,15
	26 15 715		27 x 2	6	5,95
Creuse	26 15 716	80	21 x 5	6	4,75
Ovale	26 15 718		19 x 10 x 3	6	4,15
	26 15 719		23 x 13 x 3	6	4,95
Coupelle	26 15 723	35	15 x 5,5	6	3,25

Savane 

Plate 26



Creuse

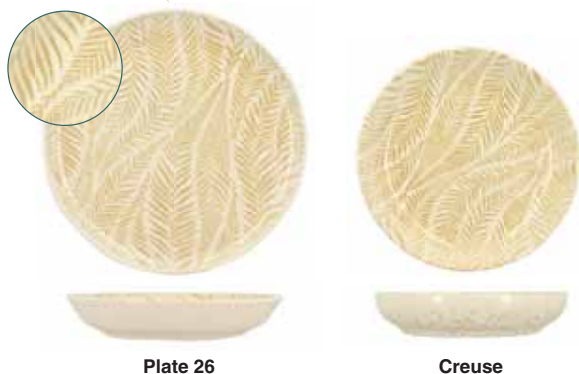

Plate 20

Désignation	Code	Ccl	Φ x Ht cm	Sur.	Prix HT
Plate	32 05 692		20 x 2	12	2,55
	32 05 690		26 x 2,5	12	3,25
Creuse	32 05 691	60	20,5 x 4	12	2,95

Dune 

Plate 26



Creuse

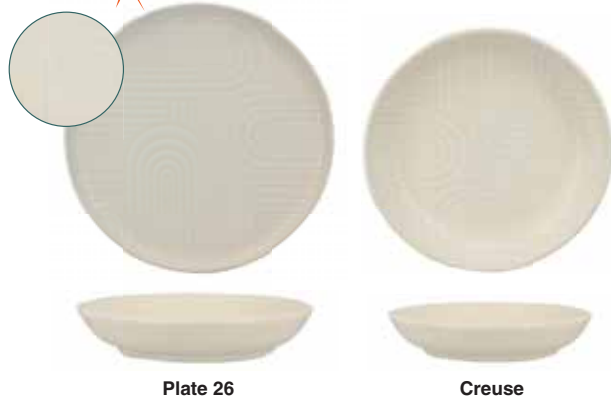

Plate 20

Désignation	Code	Ccl	Φ x Ht cm	Sur.	Prix HT
Plate	32 05 927		20 x 2	12	2,55
	32 05 925		26 x 2,5	12	3,25
Creuse	32 05 926	60	20,5 x 4	12	2,95



## RELIEF

Design épuré et contemporain, avec ses tons crème naturels, elle allie sobriété et sophistication.

Sa texture en relief géométrique apporte une touche artistique, parfaite pour sublimer vos tables sans les surcharger.



Résistance aux chocs et aux rayures



 New products  
Nouveautés

Grès

## Jaipur

novastyl



Plate



Mug



Bol

Désignation	Code	Ccl	Φ x Ht cm	Sur.	Prix HT
Plate	32 35 137		20 x 2,5	6	4,65
	32 35 135		27 x 2,5	6	5,95
Creuse	32 35 136	70	19 x 5	6	4,95
Bol	32 35 138	60	15,5 x 7	6	4,25
Mug	32 35 139	35	12 x 9 x 10	6	4,25



## FLEUR ÉCLATANTE

Les assiettes Jaipur, arborant un motif floral en relief aux couleurs pétillantes, sont l'éclatant témoignage d'une élégance artistique, apportant une touche vibrante et raffinée à votre expérience culinaire.



Décor en relief

## Héraclée



Résistance aux chocs et aux rayures

## ESPRIT MÉDITERRANÉEN

La vaisselle Héraclée en grès, arborant des motifs méditerranéens frais, est disponible en bleu et vert, ajoutant une note vibrante d'inspiration méditerranéenne à votre table.



Plate 27



Plate 19

Désignation	Couleur	Code	Φ x Ht cm	Sur.	Prix HT
Plate	Bleu	32 05 492	19 x 2	12	2,55
	Vert	32 05 497	19 x 2	12	2,55
	Bleu	32 05 490	27 x 3	12	3,25
	Vert	32 05 495	27 x 3	12	3,25



Creuse



Coupelle

Désignation	Couleur	Code	Ccl	Φ x Ht cm	Sur.	Prix HT
Creuse	Bleu	32 05 491	90	20 x 5,3	12	2,95
	Vert	32 05 496	90	20 x 5,3	12	2,95
Coupelle	Bleu	32 05 493	50	16,7 x 5,7	12	2,95
	Vert	32 05 498	50	16,7 x 5,7	12	2,95

## Jade

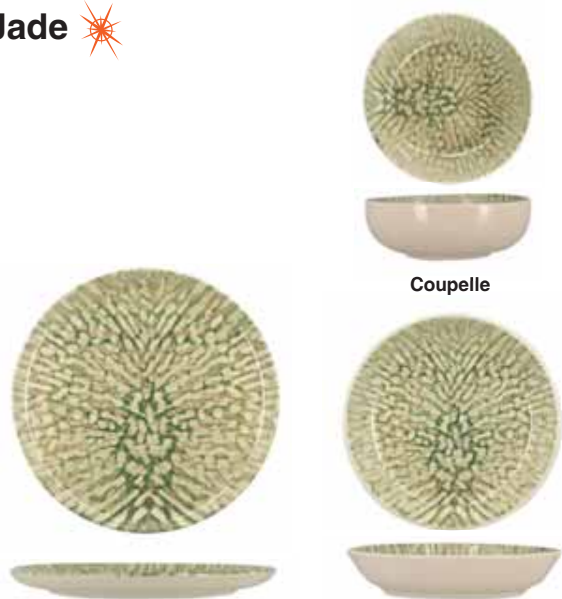

Coupelle

Plate

Creuse

Désignation	Code	Ccl	Φ x Ht cm	Sur.	Prix HT
Plate	32 05 897		20 x 2	12	2,55
	32 05 895		26 x 2,5	12	3,25
Creuse	32 05 896	60	20,5 x 4	12	2,95
Coupelle	32 05 898	60	16 x 5,5	12	2,95



### DÉCOR IMPRIMÉ

Un vert nuancé et tacheté, inspiré par la nature, pour une table tout en douceur.



## Ambre

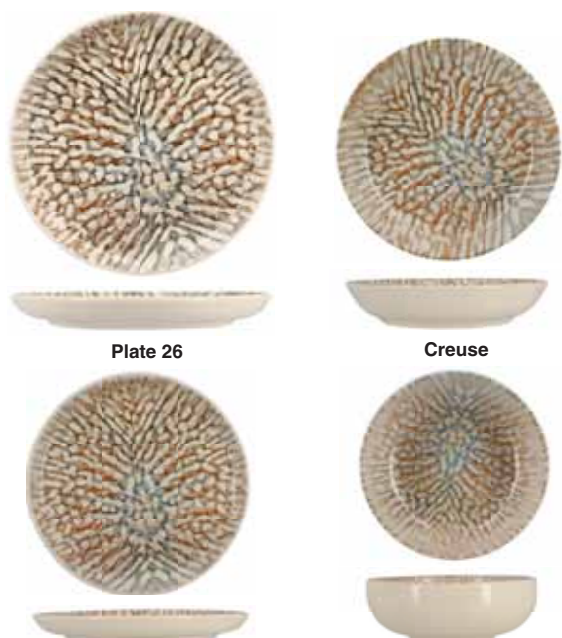

Plate 26

Creuse

Plate 20

Coupelle

Désignation	Code	Ccl	Φ x Ht cm	Sur.	Prix HT
Plate	32 05 267		20 x 2	12	2,55
	32 05 265		26 x 2,5	12	3,25
Creuse	32 05 266	60	20,5 x 4	12	2,95
Coupelle	32 05 268	60	16,5 x 5,5	12	2,95



Grès

## Florali

novastyl



Plate Ø26

Plate Ø19,5

Désignation	Code	Φ x Ht cm	Sur.	Prix HT
Plate	32 05 482	19,5 x 2	12	2,55
	32 05 480	26 x 3	12	3,25



## DÉCOR IMPRIMÉ

Décor floral décliné sur une assiette qui rappelle nos tables d'antan.



Creuse 90 cl

Bol 50 cl

Désignation	Code	Ccl	Φ x Ht cm	Sur.	Prix HT
Creuse	32 05 481	90	20,5 x 5,5	12	2,95
Bol	32 05 485	50	16 x 6,5	12	3,45

## Faustine



Plate

Creuse

Désignation	Code	Ccl	Φ x Ht cm	Sur.	Prix HT
Plate	25 13 087		20 x 2	12	3,45
	25 13 085		26 x 3,5	12	4,35
Creuse	25 13 086	30	22 x 4	12	3,75



## Faustine Rose



Plate

Creuse

Désignation	Code	Ccl	Φ x Ht cm	Sur.	Prix HT
Plate	25 13 162		20,5 x 2	6	3,45
	25 13 160		26 x 3,5	6	4,35
Creuse	25 13 161	30	22 x 4	6	3,75



### DÉCOR D'ANTAN

Redonnez vie à vos tables avec nos magnifiques assiettes d'antan au décor fleuri.

Chaque pièce raconte une histoire, empreinte d'élégance et de douceur. Le style vintage, délicatement orné de motifs floraux, apporte une touche romantique et chaleureuse à chaque repas.



Résistance aux chocs et aux rayures



## Charlotte



Plate 20

Plate 26

Creuse

Désignation	Code	Ccl	Φ x Ht cm	Sur.	Prix HT
Plate	25 13 132		20 x 2,3	6	2,95
	25 13 130		26 x 2,3	6	3,95
Creuse	25 13 131	30	22 x 3,4	6	3,55



Plate



Creuse



Plat rectangle

Désignation	Code	Ccl	Φ x Ht cm	Sur.	Prix HT
Plate	25 13 396		21 x 2	12	3,90
	25 13 395		28 x 1,7	12	4,95
Creuse	25 13 397	38	16 x 4,5	12	2,95
	25 13 398	70	20 x 5	12	4,65
Plat rectangle	25 13 400		24 x 16 x 1,5	12	4,95
	25 13 401		32 x 12 x 1,5	12	4,95



**AUTHENTICITÉ**

Élégante et naturelle, cette assiette sublime chaque moment de partage.

Son design raffiné s'adapte à toutes les ambiances, modernes ou classiques, tandis que son matériau, reconnu pour sa finesse et son authenticité, en fait un indispensable de la table.



Amatxi 

Plate

Creuse



Pizza

Pâtes

**INSPIRATION MOSAÏQUE**

Apportez une touche d'élégance et d'exotisme à votre table avec la gamme Amatxi, inspirée des mosaïques orientales et méditerranéennes.

Son design raffiné et ses couleurs harmonieuses subliment toutes les occasions et s'adaptent à tous les styles de table.

**Ovale**

Désignation	Code	Ccl	Φ x Ht cm	Sur.	Prix HT
Plate	25 13 452		20 x 2	12	2,85
	25 13 450		25 x 2,5	12	3,95
Creuse	25 13 451	70	21 x 4,5	24	3,30
Pizza	25 13 453		32 x 1,5	6	6,75
Pâtes	25 13 454		28 x 5	8	6,30
Ovale	25 13 455		26 x 12,5 x 3	6	4,05
	25 13 456		30 x 16 x 3	6	5,95

 New products  
Nouveautés



Présentation

Code	Φ x Ht cm	Sur.	Prix HT
26 30 739	30,5 x 3,2	3	6,43



Plate

Code	Φ x Ht cm	Sur.	Prix HT
26 30 735	26,5 x 2,6	6	2,50
26 30 734	24 x 2	6	2,05
26 30 737	19 x 2	6	1,65
26 30 733	15 x 2	6	1,65



Creuse

Code	Ccl	Φ x Ht cm	Sur.	Prix HT
26 30 736	29	21,5 x 3,5	6	1,85



Bol

Code	Ccl	Φ x Ht cm	Sur.	Prix HT
26 30 740	60	14,5 x 8	6	2,65



Porcelaine Blanche



Saladier

Code	Ccl	Φ x Ht cm	Sur.	Prix HT
26 30 738	130	23 x 7	3	3,25



Assiette à Pâtes

Code	Ccl	Φ x Ht cm	Sur.	Prix HT
26 30 366	27/75	23,5 x 5,6	6	2,92
26 30 367	45/130	26,8 x 5,7	6	3,25



Assiette à Pizza

Code	Ccl	Φ x Ht cm	Sur.	Prix HT
26 30 365		30 x 2,6	12	3,85

## Metropolitan



Plate



Calotte

Paire tasse  
(tasse et soucoupe)

Désignation	Code	Ccl	Φ x Ht cm	Sur.	Prix HT
Plate	26 30 863		27 x 2,9	6	2,75
	26 30 864		21 x 2,4	6	1,95
Calotte	26 30 865	70	20 x 4	6	2,25
	26 30 866	110	26,5 x 4	6	3,97
Paire tasse	26 30 867	10	12,5 x 5,5	6	13,50
(Boîte de 6)	26 30 868	20	15 x 7,5	6	16,50



Porcelaine Blanche



## Alaska



Rectangle



Plate carrée



Creuse / saladier

Paire tasse 22 cl  
(tasse et soucoupe)

Désignation	Code	Ccl	Φ x Ht cm	Sur.	Prix HT
Rectangle	26 30 375		30,5 x 19,5 x 3	12	5,85
Plate carrée	26 30 370		26,5 x 26,5 x 2,8	24	3,25
	26 30 372		20 x 20 x 2,4	24	2,05
Saladier	26 30 374	90	23,5 x 7	12	3,95
Creuse	26 30 371	50	18 x 5,4	24	2,95
Tasse	26 30 373	22	7,5-9 x 8,2	24	3,67
+ Soucoupe			14,5		



Porcelaine

## Ambassador

novastyl



Plate



Creuse



Pain

Tasses empilable  
et soucoupe

Désignation	Code	Ccl	Φ x Ht cm	Sur.	Prix HT
Plate	26 15 071		27 x 2,2	6	4,95
	26 15 072		25 x 2	6	4,31
	26 15 074		20 x 1,8	6	3,63
Creuse	26 15 073	25	23 x 3,4	6	4,06
Pain	26 15 075		16 x 1,8	6	3,13
Tasse	26 15 080	10	6-7,8 x 5	12	2,01
Soucoupe	26 15 081		12,5 x 1,6	6	1,38
Tasse	26 15 084	20	8-10,5 x 6,5	12	3,43
Soucoupe	26 15 085		16 x 1,8	6	1,91



Porcelaine Blanche Hôtelière



Texture et motif inaltérable



## Polo



Plate



Creuse

Désignation	Code	Ccl	Φ x Ht cm	Sur.	Prix HT
Plate	26 15 650		31,5 x 3,2	24	10,40
	26 15 651		27,5 x 2,6	24	4,40
	26 15 652		25,5 x 2,6	24	3,55
	26 15 653		20 x 2,4	24	3,40
Creuse	26 15 654	30	23 x 3,8	24	3,60
Pain	26 15 655		16 x 2,2	24	2,70

## Carré Hôtel



Plate carrée

Code	L x l x Ht cm	Sur.	Prix HT
26 15 443	30 x 30 x 3,1	4	11,31
26 15 439	27 x 27 x 2,6	6	7,27
26 15 440	25 x 25 x 2,8	6	5,55
26 15 442	19 x 19 x 2,6	6	5,10



Creuse carrée

Code	Ccl	Φ x Ht cm	Sur.	Prix HT
26 15 441	65	20 x 20 x 4,4	6	5,11
Pain carré				
26 15 730		16 x 16 x 2,5	6	3,50
26 15 732		14 x 14 x 2,5	6	2,85
26 15 731		12 x 12 x 2,5	6	2,55



A. Coupelle

Code	Ccl	Φ x Ht cm	Sur.	Prix HT
26 15 729	40	14 x 4,5	6	3,95
26 15 728	30	12 x 4,5	12	3,75
26 15 454	17	10 x 4,5	6	1,99



B. Saladier

Code	Ccl	Φ x Ht cm	Sur.	Prix HT
26 15 453	150	22 x 8	4	9,79
26 15 448	70	16 x 6,4	6	5,12



Plat à entrecôte rectangle

Code	L x l x Ht cm	Sur.	Prix HT
26 15 452	33 x 18,5 x 2,4	6	12,70
Plat rectangle			
26 15 449	28 x 15 x 2,4	6	6,18
26 15 450	23,5 x 11 x 2,4	6	5,15
26 15 451	15 x 13 x 2,4	6	4,25



Tasse à café



Tasse déjeuner

Code	Ccl	Φ x Ht cm	Sur.	Prix HT
26 15 444	9	5,6-7,8 x 5,8	6	3,05
scp 26 15 445		13,6 x 13,6 x 1,9	6	2,72
26 15 446	20	7,5-9,7 x 6,2	6	3,35
scp 26 15 447		15,1 x 15,1 x 2,1	6	3,07

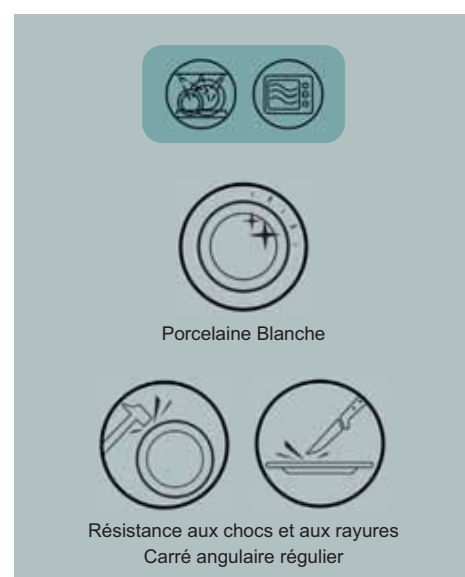

## Classic Filet Or

novastyl



Plate Ø27



Plate Ø16



Creuse



Tasse et soucoupe

Désignation	Code	Ccl	Φ x Ht cm	Sur.	Prix HT
Plate	26 15 560		27 x 1,9	6	4,46
	26 15 562		20,5 x 1,5	6	4,15
	26 15 566		16 x 1,3	6	3,73

Désignation	Code	Ccl	Φ x Ht cm	Sur.	Prix HT
Creuse	26 15 561	25	22,5 x 3,2	6	4,36
Tasse	26 15 568	16	7,2-9,2 x 6,3	12	3,41
Soucoupe	26 15 569		12,8 x 2	12	1,83



## Carbone



Plate



Creuse

Désignation	Code	Φ x Ht cm	Sur.	Prix HT
Plate	26 30 870	27 x 2,2	6	2,95
	26 30 872	19,5 x 1,8	6	2,25
Creuse	26 30 871	20,5 x 3,7	6	2,50

# OMEGA

New collection by OGO



Porcelaine blanche de qualité hôtelière.

**OGO**  
LIVING



## Wersal



Plate



Tasse à Thé 20 cl  
ronde et soucoupe

Désignation	Code	Ccl	Φ x Ht cm	Sur.	Prix HT
Plate	26 91 260		30,5 x 2,5	6	12,50
	26 91 261		27 x 2,1	6	5,95
	26 91 259		21 x 1,8	6	4,80
	26 91 262		19 x 1,6	6	4,50
Creuse	26 91 263	25	22,5 x 3,6	6	4,95
Tasse	26 91 271	20	9,3/12 x 5,6	24	3,86
Soucoupe	26 91 270		14,5 x 1,8	24	2,43

## Roma



Grande aile



Plate



Creuse

Désignation	Code	Ccl	Φ x Ht cm	Sur.	Prix HT
Plate	26 91 211		27 x 2,3	6	5,77
	26 91 208		24 x 2,1	6	4,97
	26 91 209		21 x 1,9	6	4,84
	26 91 212		19 x 1,7	6	4,06
Gde aile	26 91 310		27 x 3,8	6	10,95
Creuse	26 91 213		22,5 x 3,4	6	4,51



## Martelé



Présentation

Plate



Creuse



Paire tasse café  
(tasse et soucoupe)



Désignation	Code	Ccl	Φ x Ht cm	Sur.	Prix HT
Présentation	26 90 342		29 x 1,8	6	9,71
Plate	26 90 341		27 x 1,8	6	6,49
	26 90 340		23 x 1,8	6	5,87
Creuse	26 90 343	25	23 x 4,2	6	5,62
Paire tasse	26 90 346	10	6-8 x 6	6	6,14
Soucoupe			12 x 1,3		

## Risotto

### ÉLÉGANT ET RAFFINÉ

Une assiette pensée pour accueillir la douceur d'un risotto crémeux, entre finesse des formes et élégance des matières.

Conçues pour sublimer les présentations, nos assiettes à risotto allient design soigné et praticité au service des chefs



Porcelaine Blanche



Galaxy

Roma



Lodge

Martelé

Kaszub

Désignation	Code	Ccl	Φ x Ht cm	Sur.	Prix HT
Galaxy	26 15 634	30	28 x 4	6	7,55
	26 15 633	24	24 x 4	6	5,52
Roma	26 91 310	35	27 x 3,8	6	10,95

Désignation	Code	Ccl	Φ x Ht cm	Sur.	Prix HT
Martelé	26 90 343	25	23 x 4,2	6	5,62
Lodge	26 91 309	90	23 x 9,5	6	8,60
Kaszub	26 91 490	55	26 x 9	6	5,35

## Pasta



Porcelaine Blanche



Spécialité



Pasta



Bol Pasta empilable

Désignation	Code	Ccl	Φ x Ht cm	Sur.	Prix HT
Bol Pasta	26 30 366	27-75	23,5 x 5,6	6	2,92
	26 30 367	45-130	26,8 x 5,7	6	3,25
Bol Pasta empilable	26 91 490	55-145	26 x 9	6	5,35

## Les inclinés

novastyl



Bols Inclina



Lodge



Rita

Désignation	Code	Ccl	Φ x Ht cm	Sur.	Prix HT
Inclina	26 30 028	60	19 x 6-9	6	4,95
Lodge	26 91 309	90	23 x 7-9,5	6	8,60
	26 91 306	20	14 x 4-6	6	3,80
Rita	26 91 312	80	30 x 7	6	10,25

## Pizza



Assiette Pizza

Pizza Bianca

Désignation	Code	Φ x Ht cm	Sur.	Prix HT
Pizza	26 30 365	30 x 2,6	3	3,85
Bianca	26 45 542	31 x 1,7	6	6,15

## Assiette à compartiments



Assiette à fondue

Désignation	Code	Φ x Ht cm	Sur.	Prix HT
Fondue	26 45 519	22,5 x 23,5	4	6,95

## Creuses coupes



Metropolitan

Désignation	Code	Ccl	Φ x Ht cm	Sur.	Prix HT
Metropolitan	26 30 865	70	21 x 4	6	2,25
	26 30 866	110	26,5 x 4	6	3,97



## Saladiers



Couscous aile renforcée

Code	Ccl	Φ x Ht cm	Sur.	Prix HT
26 91 480	95	26 x 5	6	6,25
26 91 479	70	23 x 4,2	6	4,85
26 91 478	50	20 x 4	12	3,75



Carré saladier

Code	Ccl	Φ x Ht cm	Sur.	Prix HT
26 15 453	150	22 x 8	4	9,50
26 15 448	70	16 x 6,4	6	4,95
26 15 729	52	14 x 4,5	6	3,95



Carré coupelle

Code	Ccl	Φ x Ht cm	Sur.	Prix HT
26 15 728	32	12 x 4,5	12	3,75
26 15 454	17	10 x 4,5	6	1,99



Résistance aux chocs et aux rayures



Alaska

Code	Ccl	Φ x Ht cm	Sur.	Prix HT
26 30 374	90	23,5 x 7	3	3,95
26 30 371	50	18 x 5,4	6	2,95



Pasta coupe

Code	Φ x Ht cm	Sur.	Prix HT
26 15 551	26 x 5,5	6	5,55
26 15 552	30 x 6,5	6	6,32



White

Code	Ccl	Φ x Ht cm	Sur.	Prix HT
26 30 738	130	24 x 8,5	3	3,25

## Carpaccio

novastyl



Carpaccio

Désignation	Code	L x l x Ht cm	Sur.	Prix HT
Carpaccio	26 45 561	35 x 25 x 2,8	6	7,88
	26 45 560	31 x 21 x 2,5	6	4,95
	26 45 559	25 x 18 x 2,5	6	4,39



Mariott

Désignation	Code	L x l x Ht cm	Sur.	Prix HT
Carpaccio	26 15 790	39,5 x 28 x 3,5	3	13,23

## Assiette à steak



Steak grès

Désignation	Code	L x l x Ht cm	Sur.	Prix HT
Steak	32 05 225	30,5 x 24 x 3	6	5,75



Rita forme coupe

Désignation	Code	L x l x Ht cm	Sur.	Prix HT
Rita	26 45 506	33 x 25,5 x 3,2	6	3,85



Burger Time

Désignation	Code	L x l x Ht cm	Sur.	Prix HT
Burger Time	26 15 779	29,5 x 26,5 x 3	6	5,45



Steakhouse

Désignation	Code	L x l x Ht cm	Sur.	Prix HT
Steakhouse	26 15 786	29,5 x 26 x 3,9	6	5,45

Oslo



Plate

Code	N°	Φ x Ht cm	Sur.	Prix HT
26 95 001	N°7	18 x 2	48	3,51
26 95 002	N°4	22 x 2	24	4,46
26 95 003	N°3	24 x 2	24	4,76



Creuse

Code	N°	Φ x Ht cm	Sur.	Prix HT
26 95 004	N°10	13 x 2	96	2,76
26 95 005	N°9	15 x 2	72	2,76
26 95 007	N°4	22 x 2	24	4,46



Tasse à café seule



Tasse à thé seule



Tasse déjeuner seule

Code	Ccl	Φ x Ht cm	Sur.	Prix HT
26 95 020	9	5,5 x 6	48	2,78
26 95 021	12,3	3 x 2	12	2,96
26 95 022	15	8 x 5	48	3,23
26 95 026	28	10 x 6,5	36	3,91



3 Compotiers



2 Coupelles



2 Ravier

Code	Ccl	Φ x Ht cm	Sur.	Prix HT
26 95 055	15	12 x 3,5	48	2,33
26 95 056	22,5	13,3 x 4,5	48	2,70
26 95 057	37	16 x 4,5	36	3,26
26 95 062	8	10 x 2,5	48	1,76
26 95 063	16	13 x 3	48	2,63
26 95 069	20	11 x 11 x 3,5	72	2,45
26 95 070	25	15 x 9 x 3,5	72	2,58



Porcelaine Blanche



Bords renforcés  
Parfaitement empilable



2 Bols Oslo



Bol Arcole

Code	Ccl	Φ x Ht cm	Sur.	Prix HT
26 95 014	40	13,8 x 5,5	36	4,64
26 95 015	60	16 x 6	36	5,51
26 95 035	40	13 x 7	36	3,43



2 Ramequins



Plat sabot

Code	Ccl	Φ x Ht cm	Sur.	Prix HT
26 95 086	11	8,4 x 5	48	2,61
26 95 087	19	10 x 5	48	2,93
26 95 071	44	19 x 11 x 4	36	4,38



Opal

## Autonomy

Cette gamme vise à faciliter les repas des personnes âgées en perte d'indépendance grâce à des assiettes fonctionnelles et adaptées



Chope



Filet Rouge



Blanc



Filet Bleu

Désignation	Code	Φ x Ht cm	Sur.	Prix HT
Autonomy Blanc	75 50 880	19 x 2,7	12	4,80
	75 50 881	23,5 x 2,7	12	5,50
Autonomy filet Bleu	75 50 885	19 x 2,7	12	6,35
	75 50 886	23,5 x 2,7	12	7,25
Autonomy filet Rouge	75 50 890	19 x 2,7	12	6,35
	75 50 891	23,5 x 2,7	12	7,25
Autonomy Creuse Blanc	75 50 882	23 x 4	12	5,50
Autonomy Creuse Bleu	75 50 887	23 x 4	12	7,25
Autonomy Creuse Rouge	75 50 892	23 x 4	12	7,25
Gobelets Autonomy	75 07 470	9,2 x 11,5	12	2,46

## Heat System

ARCOROC  
Opal  
SHARING MATTHEI



Plate Blanche



Plate Blanche à 2 compartiments

Désignation	Code	Ccl	Φ x Ht cm	Sur.	Prix HT
Blanche	75 50 900		23 x 2,5	24	9,29
Blanc. 2 compartiments	75 50 901		23 x 2,5	24	10,21



Bol



Bol à potage

Désignation	Code	Ccl	Φ x Ht cm	Sur.	Prix HT
Bol	75 50 052	62	12 x 6,2	24	2,88
Bol Opal blanc	75 50 527	50	12,7-16,3 x 6,8	24	4,45



Assiette carrée Restaurant



Désignation	Code	Φ x Ht cm	Sur.	Prix HT
Assiette carrée Restau.	75 50 057	20 x 20 x 3	12	6,69

## Nova Aquitania



Bol 230 gr / 50 cl

Creuse 56 cl



Plate 290 gr

Désignation	Coloris	Code	Ccl	Φ x Ht cm	Sur.	Prix HT
Plate	Blanc	75 50 368		22,5 x 1,9	24	1,44
Dessert	Blanc	75 50 369		15,5 x 1,4	24	1,31
Creuse	Blanc	75 50 384	56	22,5 x 2,6	24	1,46
Coupelle	Blanc	75 50 385	20	13 x 3,5	36	1,31
Bol	Blanc	75 50 386	50	13,2 x 6,8	36	1,68

## Assiettes compartimentées



Assiette ronde 2 parties



Assiette ronde 3 parties

Désignation	Code	Ccl	Φ x Ht cm	Sur.	Prix HT
Assiette ronde 2 parties	75 50 053		23	12	11,32
Assiette 3 compartiment	75 50 302		23 x 2,5	12	11,32

New products  
Nouveautés

## Restaurant Uni



## Restaurant Filet Rouge Bordeaux



Plate



Creuse 69 cl



Plate



Creuse



Assiette à steak



Tasse empilable Restaurant et sous-tasse

Désignation	Code	Ccl	Φ x Ht cm	Sur.	Prix HT
Assiette	75 50 002		25,4 x 2,5	12	5,03
	75 50 003		23,5 x 2,6	24	4,65
	75 50 004		22,5 x 3,5	24	4,65
	75 50 008		19,5 x 2,2	24	4,06
	75 50 005		15,5 x 1,8	24	3,15
Creuse	75 50 010	69	22,5 x 3,5	24	4,65
Assiette à steak	75 50 013		30 x 26	6	6,17
Tasse	75 50 032	25	8,5 x 7	36	2,60
	75 50 031	22	7,8 x 7,4	48	2,47
	75 50 029	19	7,8 x 6,4	48	2,40
	75 50 027	13	6,9 x 5,7	48	2,40
	75 50 025	8	6 x 5	48	1,89
Sous-tasse	75 50 033		15,3 x 2,1	36	2,07
	75 50 030		14 x 1,9	48	1,86
	75 50 028		13 x 1,8	48	1,62
	75 50 026		11,2 x 1,6	48	1,52

Désignation	Code	Ccl	Φ x Ht cm	Sur.	Prix HT
Plate	75 50 062		23,5 x 2,6	24	5,73
Dessert	75 50 067		19,5 x 2,2	24	5,19
	75 50 064		15,5 x 1,8	24	4,06
Creuse	75 50 069	69	22,5 x 3,5	24	5,73
Bol empilable	75 50 098	51	13,2 x 7,4	36	4,65
Saladier empilable	12,5 75 50 088	31,5	12 x 4,7	36	3,91

## Brush



Couppelles  
11 cl empilable

Saladiers 31,5 cl

Assiettes creuses 63 cl

Assiettes plates

Bols empilables 51 cl

Ravier

Désignation	Φ x Ht	Vert	Jaune	Orange	Cherry	Blue jean's	Sur.	Prix HT
Assiette	23,5 x 2,6	75 51 235	75 51 245	75 51 225	75 51 541	75 51 521	6/24	6,89
	19,5 x 2,2	75 51 237	75 51 247	75 51 227	75 51 542	75 51 522	6/24	6,10
	15,5 x 1,8	75 51 236	75 51 246	75 51 226	75 51 543	75 51 523	6/24	5,54
Creuse 63	22,5 x 3,5	75 51 238	75 51 248	75 51 228	75 51 544	75 51 524	6/24	6,89
Couppelle empil. 11 cl	12 x 2,6	75 51 239			75 51 545	75 51 525	6/36	4,43
Saladier 31,5 cl	12 x 4,7	75 51 244	75 51 254		75 51 547	75 51 527	6/36	4,43
Bol 51 cl	13,2 x 7,4	75 51 240	75 51 250	75 51 230	75 51 548	75 51 528	6/36	5,52
Ravier carré 20 cl	11 x 11 x 3,6				75 51 546	75 51 526	6/24	7,19

Bocks 25cl, tasses 19cl, sous tasse 140 et autres couleurs, nous consulter.

### Opal MULTI RÉSIDENCES CHOCS, RAYURES, LAVAGES

- Jusqu'à 3 fois plus résistante aux chocs que les autres matières du marché.
- Résistance durable aux rayures de couteaux.
- Excellente résistance aux lavages de la surface et des décors après 2000 lavages industriels.



SECURITE : 0% porosité, 0% bactéries.

GESTION DE LA TEMPERATURE : MAINTIEN DE LA CHALEUR, SECURITE MICRO-ONDE  
- Un maintien de la température aussi efficace que les autres matériaux du marché.  
- Se manipule sans risque de brûlure après un passage au micro-onde.

PRESERVATION DE L'ENVIRONNEMENT :  
- 100% verre, 100% recyclable : matière respectueuse de l'environnement.



Opal

## Everydays Restaurant Slim



Plate



Creuse

Désignation	Code	Ccl	Φ x Ht cm	Sur.	Prix HT
Plate	75 45 930		26,5 x 2,1	24	1,85
	75 45 931		24,5 x 2,1	24	1,50
	75 45 933		19,5 x 1,5	24	1,45
Creuse	75 45 932	50	22,5 x 3	24	1,50

## Evolutions Black



## Evolutions Coupe White

Opal  
SHARING MATTHEI  
ARCOROC



Plate coupe



Coupelle 40 cl



Coupelle 60 cl



Assiette calotte 78 cl

Désignation	Code	Ccl	Φ x Ht cm	Sur.	Prix HT
Plate coupe	75 50 350		27 x 1,8	24	2,13
	75 50 351		25 x 1,7	24	1,96
	75 50 353		19 x 1,7	24	1,84
Coupelle	75 50 354	40	12,5 x 5,5	36	1,84
	75 50 733	60	17 x 4	12	2,29
Calotte	75 50 352	78	20 x 4,2	24	1,98



Résistance aux chocs et aux rayures légères mais avec les qualités de solidité de l'opal.



Plate



Rectangle



Creuse



Assiette à steak

Désignation	Code	Ccl	Φ x Ht cm	Sur.	Prix HT
Plate	75 50 375		27 x 1,8	24	2,27
	75 50 374		25 x 1,7	24	2,09
	75 50 373		19 x 1,7	24	1,98
Pizza	75 50 378		32 x 2,4	12	4,83
Rectangle	75 50 376		28 x 23 x 2,2	12	3,01
Creuse	75 50 372	78	20 x 4,2	24	2,09
Creuse Couscous	75 50 371	120	26 x 4,5	12	4,83
Pasta	75 50 377	115	28,5 x 4,5	12	4,83
Steak	75 50 370		30 x 3	12	4,83

## Stairo



Opal  
ARCOROC



Plate



Bol

Désignation	Code	Ccl	Φ x Ht cm	Sur.	Prix HT
Plate	75 50 611		27 x 2,5	24	1,86
	75 50 612		25 x 2,3	24	1,51
	75 50 615		23,5 x 2,1	24	1,41
	75 50 614		19 x 1,9	24	1,39
Creuse	75 50 613		23,6 x 3,2	24	1,51
Bol	75 50 619	50	13,2 x 6,8	36	1,96

## Les Bols



A. Uni blanc 48 cl



B. Ebro 50 cl



C. Régithermie 40 cl



D. Restaurant uni 52 cl



E. Potage anses 50 cl



F. Consommé anses 31 cl

Désignation	Code	Ccl	Φ x Ht cm	Sur.	Prix HT
A. Uni Blanc	75 50 525	48	13,2 x 6,8	36	1,84
B. Ebro	16 60 004	50	14 x 7	36	1,68
C. Régithermie	75 50 052	40	12 x 6,2	24	2,88
D. Restaurant	75 50 050	52	13,2 x 7,4	36	2,22
E. Potage anses	75 50 527	50	16,3-12,7 x 6,9	24	4,45
F. Consommé	75 50 051	31	10,2 x 5,8	24	3,74

## Feston



Feston caracas

Désignation	Code	Φ x Ht cm	Sur.	Prix HT
Plate	75 50 555	27,3 x 2,3	6	1,85
	75 50 554	25 x 2,2	6	1,50
	75 50 556	23 x 2,1	6	1,50
	75 50 558	19 x 1,9	6	1,40
Creuse	75 50 557	21 x 3	6	1,50
Plat	75 50 559	30 x 2,2	6	5,60
Plat creux	75 50 560	28 x 4,6	4	5,65
Plat ovale	75 50 561	33 x 25	6	5,60
Saladier	75 50 564	24 x 10	6	4,45
	75 50 563	12 x 5,2	6	1,40

## Cylindriques empilables



Tasse cylindrique empilable



Bock empilable

Désignation	Code	Ccl	Φ x Ht cm	Sur.	Prix HT
Tasse	75 50 516	28	11,7 x 6,1	24	3,02
	75 50 514	22	10,3 x 6,5	24	2,25
	75 50 512	14	9,8 x 4,9	24	2,02
Sous-tasse	75 50 517		16 x 2,1	48	2,65
	75 50 515		14 x 1,8	72	2,45
	75 50 026		11 x 1,6	48	1,52
Bock	75 50 528	29	7,9 x 9	36	1,70
	75 50 529	25	7,2 x 9	36	2,40

## Complément Opal



Compotier



Multi-usage



Raviers empilable



Saladier empilable

Désignation	Code	Ccl	Φ x Ht cm	Sur.	Prix HT
Compotier	75 50 041	27,5	16 x 3,6	36	3,32
	75 50 040	11	12 x 2,6	36	2,62
Multi-usage	75 50 042	52	16 x 5,1	24	3,36
Ravier	75 50 043	28	14 x 9 x 3,5	24	4,65
Saladier	75 50 044	25	11 x 11 x 3,6	24	4,47
	75 50 023	48	14 x 14 x 5,2	36	4,08
	75 50 038	31,5	12,1 x 4,7	36	2,62



Plat de présentation



Plat de service avec cloche

Désignation	Code	Φ x Ht cm	Sur.	Prix HT
Plat service	16 18 826	31,5 x 18,5	4	14,00

## Lys



Plate

Calotte

Désignation	Code	Φ x Ht cm	Sur.	Prix HT
Plate	75 28 001	23 x 2,2	24	2,04
Calotte	75 28 004	21 x 4,7	36	1,80



Plat à tarte

Plat à tarte + cloche

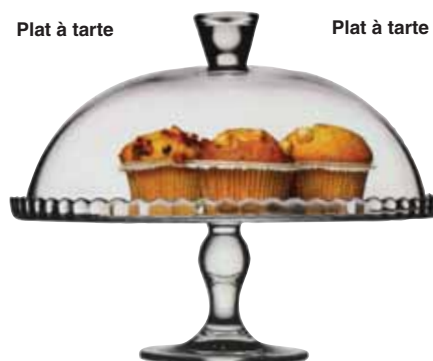

Plat sur pied + cloche

Désignation	Code	Φ x Ht cm	Sur.	Prix HT
Plat sur pied	16 13 280	33 x 29	2	18,52
Plat + cloche	16 13 281	32 x 18	2	13,55
Plat	16 13 282	32 x 2	10	5,60

## Génération



Plate

Creuse

Désignation	Code	Φ x Ht cm	Sur.	Prix HT
Plate	16 13 242	27 x 2	24	1,65
Dessert	16 13 244	19 x 1,3	24	1,25
Creuse	16 13 243	21 x 3,5	24	1,50

## Picardie / Paris



Plate

Creuse

Désignation	Code	Φ x Ht cm	Sur.	Prix HT
Plate	75 28 200	23 x 1,6	48	1,74
Creuse	75 28 201	23 x 3,5	48	1,74

## Saladiers en verre



Saladier cocoon

Désignation	Code	Ccl	Φ x Ht cm	Sur.	Prix HT
Saladier cocoon	75 16 072	360	24 x 13,2	4	7,25
	75 16 070	150	18 x 9,8	6	5,90
	75 16 068	41	12 x 6,7	36	2,30
	75 16 066	4,5	6 x 3,3	36	1,45



Saladier empilable

Désignation	Code	Ccl	Φ x Ht cm	Sur.	Prix HT
Saladier empil.	75 16 020	600	29 x 13,3	6	10,09
	75 16 019	430	26 x 1,9	6	7,83
	75 16 018	290	23 x 10,5	6	5,26
	75 16 017	190	20 x 9,2	6	4,11
	75 16 016	110	17 x 7,8	24	2,27
	75 16 015	62,5	14 x 6,5	36	1,98
	75 16 014	36,5	12 x 5,5	36	1,28
	75 16 013	24	10 x 4,9	36	1,04
	75 16 012	15	9 x 4,1	36	1,01
	75 16 011	7,5	7 x 3,5	36	0,90
	75 16 010	3,2	6 x 2,7	36	0,83



Mister chef

Désignation	Code	Ccl	Φ x Ht cm	Sur.	Prix HT
Mister chef	13 10 577	395	30 x 12,7	6	14,90
	13 10 576	260	26 x 11,2	6	9,96
	13 10 575	162	22 x 9,7	6	7,87
	13 10 574	75	17 x 7,5	12	5,04
	13 10 573	37	14 x 6,1	24	3,08
	13 10 572	18,2	11 x 4,8	24	2,35
	13 10 570	8,5	9 x 3,7	36	1,75

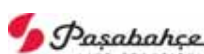

Saladier Chef

Désignation	Code	Ccl	Φ x Ht cm	Sur.	Prix HT
Empilable	16 11 878	34	12 x 5,5	48	1,30
	16 11 879	59,5	14 x 6,5	36	1,73
	16 11 880	110	17 x 7,5	24	2,52
	16 11 881	170	20 x 9,5	12	4,38
	16 11 882	250	23 x 11	6	5,10
	16 11 883	390	26 x 11	6	7,50
	16 11 884	550	30 x 12,5	2	11,88



New products  
Nouveautés

Inox



Fond extérieur antidérapant en silicone noir.



Saladier inox antidérapant

Désignation	Code	Ccl	Φ x Ht cm	Sur.	Prix HT
Saladier inox	46 15 340	130	18 x 9	12	3,85
	46 15 341	250	22 x 10,4	12	4,85
	46 15 342	370	25,5 x 12	12	6,85



Plat gratin inox ovale renforcé

Désignation	Code	Ccl	Φ x Ht cm	Sur.	Prix HT
Plat gratin	47 37 122		30 x 18	6	14,82
	47 37 121		25 x 15	6	12,21
	47 37 124		38 x 23	6	20,19
	47 37 114	265	34 x 27 x 6,5	6	20,07
	47 37 112	155	28 x 22 x 5,5	6	15,06
	47 37 111	75	22 x 18 x 4,5	6	10,20



Légumier renforcé



Panier inox



Désignation	Code	Ccl	L x l x Ht cm	Sur.	Prix HT
Panier inox	37 21 270		19-10 x 8,5	6	6,95

Saladier boule



novastyl

Désignation	Code	Ccl	Φ x Ht cm	Sur.	Prix HT
Saladier boule	46 15 298	500	29 x 13,5	6	7,95
	46 15 297	370	24 x 12	6	6,01
	46 15 296	150	19 x 9,5	6	3,85
	46 15 295	75	15 x 8	6	2,45



Corbeille à pain en inox

Désignation	Code	L x l x Ht cm	Sur.	Prix HT
Corbeille	46 15 345	18 x 8	6	3,67
	46 15 346	20 x 10,5	6	4,25

Rivage - Mélamine



Plate



Coupelle

Désignation	Ccl	Code	Φ x Ht cm	Sur.	Prix HT
Plate		63 17 705	27 x 1,3	6	4,55
Dessert		63 17 706	21 x 1,3	6	3,65
Coupelle	65	63 17 707	16 x 4,8	6	2,95

Kuwae - Mélamine

novastyl



Plate



Coupelle

Désignation	Couleurs	Ccl	Code	Φ x Ht cm	Sur.	Prix HT
Plate	Vert		63 17 800	27,5 x 2	6	4,55
	Bleu		63 17 803	27,5 x 2	6	4,55
	Jaune		63 17 835	27,5 x 2	6	4,55
Coupelle	Vert	65	63 17 799	16 x 6,2	6	2,95
	Bleu	65	63 17 806	16 x 6,2	6	2,95
	Jaune	65	63 17 837	16 x 6,2	6	2,95

## Couvretes



Cocotte ronde avec couvercle



Tajine

Désignation	Code	Cgr	L x l x Ht cm	Sur.	Prix HT
Cocotte ronde	75 41 429	100	20 x 12,3	1	13,55
Tajine	29 40 105		20 x 18	1	8,05

## Escargot - Huître



Porcelaine



Inox

Plat à escargot 6 trous



Porcelaine



Inox

Plat à escargot 12 trous

Désignation	Code	Φ x Ht cm	Sur.	Prix HT
6 trous				
Porcelaine	29 40 034	16-18 x 2,5	6	2,80
6 x plats inox	46 15 204	15,5-19 x 1,6	6	10,29
12 trous				
Porcelaine	26 30 801	22-20 x 2,5	6	4,65
6 x plats inox	46 15 205	21-25,5 x 1,8	6	15,80

## Terrines



Terrine foie gras



Terrines rectangulaires

Désignation	Code	Cgr	L x l x Ht cm	Sur.	Prix HT
Terrine Foie gras	29 40 460	1000	18,5 x 13 x 9	6	8,95
	29 40 029	600	17,5 x 13 x 7	6	5,35
	29 40 027	400	15 x 11 x 7	6	4,35
	29 40 026	200	11 x 8 x 5	6	3,35
Terrine Restangle	29 40 455	600	24,5 x 10,5 x 8	8	10,95



Pince Escargot



Huître Bourget



Fourchette escargot Bourget



Couteau huître bleu



Fourchette escargot Valmy



Huître Valmy



Couteau huître noir

Désignation	Code	L cm	Sur.	Prix HT
Pince escargot	47 10 448	15,5	12	4,12
Bourget	47 10 445	13	12	0,51
Valmy fourchette escargot	48 35 987	13	12	0,46
Valmy fourchette huître	48 35 986	13	12	0,32
Bourget	47 10 449	13	12	0,51
Couteau huître bleu	50 50 844	15	6	8,17
Couteau huître noir	47 10 453	15	12	2,05

## Les Coquetiers

Coquetier grès bicoloré  
(6 coloris assortis)Coquetier grès poule  
(3 coloris assortis)

Coquetier

Désignation	Code	Ccl	Φ x Ht cm	Sur.	Prix HT
Grès bicoloré	24 25 740	5	10 x 5	12	2,15
Grès poule	30 20 837		5,3 x 6,5	12	1,55
Coquetier	26 30 107	5	4,7 x 6,8	12	0,95



Soupière tête de lion

Coquille Saint  
Jacques blanc

Moule à flan blanc

Désignation	Code	Ccl	Φ x Ht cm	Sur.	Prix HT
Coquille blanc	26 30 108	20	14 x 13 x 3,5	6	2,50
Soupières	29 40 073	250	23,5 x 13	1	10,50
Tête de lion	29 40 074	160	20,5 x 12,8	8	10,73
	26 30 110	45	11 x 8,5	6	2,91
	29 40 002	10	6 x 5	12	2,45
Moule flan blanc	29 40 096	10	13,5 x 3,5	6	2,65



## Les individuels



**Comptier haut empilable**

Code	Ccl	Φ x Ht cm	Sur.	Prix HT
29 40 247	37	15,5 x 4,4	12	2,96
29 40 246	22,5	13 x 4	12	2,06
29 40 245	15	12 x 3,5	12	1,78



**Assiette à salade empilable**

Code	Ccl	Φ x Ht cm	Sur.	Prix HT
29 40 025	95	18 x 5,5	6	4,75



**Plat rond avec anses Optiva**

Code	Ccl	Φ x Ht cm	Sur.	Prix HT
26 32 824	25	15 x 3,7	12	7,39
26 32 822	45	21 x 17 x 3,8	12	7,81
26 32 823	65	20 x 4,5	12	11,11



**Assiette Marjolaine 'Welsh'**

Code	Ccl	L x l x Ht cm	Sur.	Prix HT
33 56 060	65	19 x 25 x 4,8	6	4,25



**Plat ovale à oreilles**

Code	Ccl	L x l x Ht cm	Sur.	Prix HT
29 40 007	35	26 x 14 x 4,8	6	4,85



**Plat léger à oreilles**

Code	Ccl	Φ x Ht cm	Sur.	Prix HT
29 40 044	12	17,5 x 14 x 2,8	8	2,95
29 40 045	9	15,5 x 12,7 x 2,8	6	2,55
29 40 035	7	7-9 x 1,7	20	0,99



**Gratin ovale empilable**

Code	Ccl	L x l x Ht cm	Sur.	Prix HT
29 40 241	90	23 x 16 x 5	6	4,05
29 40 031	45	19 x 12 x 4	6	2,90



**Ravier rectangle empilable**

Code	Ccl	L x l x Ht cm	Sur.	Prix HT
29 40 242	60	22 x 16 x 4	6	4,05
29 40 240	45	19 x 13 x 4	6	3,35
29 40 032	30	14 x 9 x 4	6	2,15



**Ravier carré empilable**

Code	Ccl	L x l x Ht cm	Sur.	Prix HT
29 40 018	20	11 x 11 x 4	12	1,95



**Cuillère Chinoise**

Code	Ccl	Φ x Ht cm	Sur.	Prix HT
29 40 065	1	13 x 4,8	60	0,75
29 40 066	0,5	11 x 4,2	60	0,55



**Vide poche**

Code	Ccl	Φ x Ht cm	Sur.	Prix HT
29 40 064		10 x 2	6	2,02



**A. Bol à sauce**

Code	Ccl	Φ x Ht cm	Sur.	Prix HT
A.29 40 079	10	8 x 3	120	1,95
B.29 40 048	13	8,5 x 3,8	24	1,95



**B. Coupelle lotus**

## Les Bols



**C. Bol à riz**

Code	Ccl	Φ x Ht cm	Sur.	Prix HT
C.26 47 616	30	11 x 6	3	1,85
D.29 40 301	40	13 x 7,2	6	2,55



**D. Bol calice**



**E. Bol White**

Code	Ccl	Φ x Ht cm	Sur.	Prix HT
E.26 30 740	60	14,5 x 8	6	2,65
F.29 40 038	40	13,2 x 7,5	6	2,85



**F. Campagne à côtes**



**G. Hôtel**

Code	Ccl	Φ x Ht cm	Sur.	Prix HT
G.29 40 039	40	13 x 6,5	6	2,85

## Grès

OGO



Ramequin Octave en grès

Désignation	Ccl	Code	Φ x Ht cm	Sur.	Prix HT
Beige	18	33 56 145	9 x 5	12	1,85
	40	33 56 150	12 x 6	6	3,65
Terracotta	18	33 56 146	9 x 5	12	1,85
	40	33 56 151	12 x 6	6	3,65
Kaki	18	33 56 147	9 x 5	12	1,85
	40	33 56 152	12 x 6	6	3,65



Pasabahçe



Ramequin (x6)

Désignation	Code	Ccl	Φ x Ht cm	Sur.	Prix HT
Ramequins (Boîte de 6)	16 13 504	12,5	8 x 4	8	4,97



Ramequin trempé



Bol parisien lys à oreilles



Bol Parisien transparent

Désignation	Code	Ccl	Φ x Ht cm	Sur.	Prix HT
Trempé Duralex	75 28 121	24	10 x 4	4	1,67
	75 28 120	13	8,5 x 4	96	1,19
Bol à oreilles	75 28 099	51	13,5 x 6,5	6	1,85
Bol Parisien	13 10 205	51	13,5 x 6,5	6	1,94

## Inox



Ramequin Inox

Désignation	Ccl	Code	Φ x Ht cm	Sur.	Prix HT
Ramequin	4,5	47 10 589	6 x 2,5	50	0,86
Inox	7,5	47 10 590	5,7 x 4,2	50	0,97
	12	47 10 591	6,6 x 4,7	50	1,09
	23,5	47 10 592	9 x 6	50	3,25

Menastyl



Ramequin Fiorella

Ramequin canelle



Ramequin blanc

novastyl



Ramequin conique grès

Désignation	Code	Ccl	Φ x Ht cm	Sur.	Prix HT
Ram. Fiorella	33 56 220	20	9 x 5,5	12	2,40
Ram. canelle	33 56 052	22,5	9,3 x 5,6	12	1,65
Ram. conique Ramequin	29 40 087	10	7-5 x 4	10	1,25
Ramequin	29 40 003	160	19 x 11	2	5,95
	29 40 077	35	11 x 6	72	1,65
	29 40 005	28	10 x 4	12	1,55
	29 40 006	20	9 x 4	12	1,50
	29 40 004	12	8 x 4	12	1,45
	29 40 054	9	7 x 3,5	12	1,25

Borrioli



Ramequin trempé empilable Lyon

PYREX



Ramequin Pyrex

Désignation	Code	Ccl	Φ x Ht cm	Sur.	Prix HT
Trempé Lyon	75 28 125	14	8,5 x 4,1	36	1,17
Ramequin Pyrex	14 50 103	20	10 x 4,7	12	3,66

DURALEX

Luminarc

ARCOROC



Beurrier verre



Lot de 3 rapiers trempé empilable

Désignation	Code	Ccl	Φ x Ht cm	Sur.	Prix HT
Beurrier	75 16 329	30	17 x 10,5 x 6	6	6,99
Lot 3 rapiers	75 16 009	28	14 x 9 x 3,5	8	13,65



Coupelle carré trempé empilable duralex



Ravier trempé rectangle empilable duralex

Désignation	Code	Ccl	L x l x Ht cm	Sur.	Prix HT
Carré	75 27 035	30	11 x 11 x 4,6	72	1,31
	75 27 037	15	9 x 9 x 3,9	72	1,16
Rectangle	75 28 115	37	15 x 9 x 4	6	2,32

 New products  
Nouveautés

## Coupes à dessert

## Coupes verres



Onctuose + couvercle



Chiquito

Désignation	Code	Ccl	Φ x Ht cm	Sur.	Prix HT
Onctuose avec couvercle	75 16 250	22	8,2 x 5,9	24	2,63
Coupelle seule (x 24)	75 16 249	22	8,2 x 5,9	1	33,55
Couvercle seul	75 16 245		8,5 x 1	24	0,85
Chiquito	75 07 154	23	8,3 x 5,9	6	1,51



Sorbet GM



Seychelles



Pépité

Désignation	Code	Ccl	Φ x Ht cm	Sur.	Prix HT
Sorbet GM	75 12 010	38	11,7 x 9,4	24	5,80
	75 12 009	22	10 x 7,8	24	4,65
Seychelles	75 12 045	20	10,5 x 7,8	24	2,56
Pépité	75 12 097	20	10,8 x 6	24	3,12



Rock bar



Fortuna

Désignation	Code	Ccl	Φ x Ht cm	Sur.	Prix HT
Rock bar	75 35 130	38	8,5 x 18,8	6	5,00
Fortuna	75 35 186	32	12,5 x 18	6	7,94



Ypsilon



Fizz



Ovale

Désignation	Code	Ccl	Φ x Ht cm	Sur.	Prix HT
Ypsilon	75 34 094	39	13 x 9	12	5,18
Fizz	75 34 438	22	9 x 12,4	24	4,03
Ovale	75 42 220	25	11,3 x 8,1	6	4,58



Diamond



Diamond basse

Désignation	Code	Ccl	Φ x Ht cm	Sur.	Prix HT
Diamond	75 35 244	36	11,5 x 9,9	6	3,98
	75 35 240	22	10,2 x 8,6	12	3,20
Diamond basse	75 35 238	22	11 x 6	12	3,20

## Timeless

Gobelet  
(boîte de 4)Coupe glace  
(boîte de 2)Vap forme haute  
(boîte de 4)

Désignation	Code	Ccl	Φ x Ht cm	Sur.	Prix HT
Gobelet (x4)	16 13 216	22,5	9 x 5,4	6	8,51
Coupe glace (x2)	16 11 582	25	9,8 x 10	12	4,96
Vap haute (x4)	16 13 189	32	8,7 x 15	6	13,46



Coupes verres



Jolly



Versatile



Jazzed

Désignation	Code	Ccl	Φ x Ht cm	Sur.	Prix HT
Jolly	75 12 153	35	9,2 x 12,5	24	4,01
	75 12 154	45	9,7 x 13,8	24	4,69
Versatile	75 12 129	12	8,7 x 9	24	2,24
	75 12 128	4	6 x 6,2	12	1,41
Jazzed	75 12 080	41	12,5 x 19,8	12	8,67



Palmer grand



Palmer petit



Quadro

Désignation	Code	Ccl	Φ x Ht cm	Sur.	Prix HT
Palmer grand	75 12 071	37	12 x 20,1	24	8,89
Palmer petit	75 12 070	21	12,5 x 10,1	24	5,14
Quadro	75 12 055	36	8,2 x 19	24	6,31



Simple

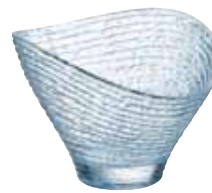

Frozen



Diamant

Désignation	Code	Ccl	Φ x Ht cm	Sur.	Prix HT
Simple	75 12 082	25	13,4 x 9,2	12	5,90
Frozen	75 12 145	25	13,4 x 9,2	12	5,90
Diamant	75 12 160	20	10 x 6,2	24	3,21



A.



B.



C.



D.

Désignation	Code	Ccl	Φ x Ht cm	Sur.	Prix HT
A. Vague x6	16 18 317	30	11 x 11 x 6	8	7,85
B. Vague x6	16 18 307	6,5	7 x 4	4	4,85
C. Triangle x6	16 18 318	30	12,1 x 5,5	8	7,85
D. Triangle x6	16 18 308	6,9	7 x 4	4	4,85



New products  
Nouveautés



**Régal (lot de 6)**      **Narok (lot de 6)**      **Invitation (lot de 6)**

Désignation	Ccl	Code	Φ x Ht cm	Sur.	Prix HT
Régal (x6)	9,5	16 18 062	7,7 x 6	6	4,50
Invitation (x6)	8	16 18 040	5,6 x 6	6	4,75
Narok (x6)	10	16 11 465	5 x 7,8	12	2,88



**Barista Chicago (lot de 6)**      **Boston (lot de 6)**

Désignation	Ccl	Code	Φ x Ht cm	Sur.	Prix HT
Chicago (x6)	4,5	16 18 083	5 x 5,5	4	4,50
Boston (x6)	6,2	16 18 084	5 x 7,3	4	4,50



**Boston 7cl**      **Boston 3,5cl**      **Boston Loop**

Désignation	Ccl	Code	Φ x Ht cm	Sur.	Prix HT
Boston	7	75 41 037	5,1 x 8,3	12	0,92
	3,5	75 41 036	4,9 x 5,9	12	0,92
Boston Loop	3	75 41 038	4,3 x 7	12	0,92



**Elysia (lot de 6)**      **Timeless (lot de 4)**      **Casablanca**

Désignation	Ccl	Code	Φ x Ht cm	Sur.	Prix HT
Elysia (x6)	6	16 13 084	4,6 x 6,6	4	9,66
Timeless (x4)	6	16 13 214	4,8 x 6,2	12	6,21
Casablanca	3,6	75 41 191	4,8 x 5,5	12	0,75



**Mini rock bar**      **Mini rock bar**      **Dublino**

Désignation	Ccl	Code	Φ x Ht cm	Sur.	Prix HT
Shot Barglass	6,5	75 34 532	4,7 x 7	48	1,68
Mini rock bar	7	75 25 072	5,1 x 6,4	54	1,10
Dublino	5,7	75 34 039	5 x 9	48	1,31
	3,4	75 34 040	4,5 x 7	72	1,07



**Cafféino**      **Caravelle**      **Novecento**

Désignation	Ccl	Code	Φ x Ht cm	Sur.	Prix HT
Cafféino	8,5	75 30 035	5,9 x 7,1	48	0,97
Caravelle	10	75 30 006	5,7 x 6,8	24	0,92
	4,5	75 30 007	4,4 x 5,4	48	0,87
Novecento	7,7	75 34 502	5,5 x 7,9	24	2,30



**Gigogne**      **Picardie**

Désignation	Ccl	Code	Φ x Ht cm	Sur.	Prix HT
Gigogne	9	75 25 025	5,8 x 6	72	0,81
Picardie	9	75 25 060	6,5 x 6,7	144	0,88



ARCOROC



Gin



Salto



Baril

Désignation	Ccl	Code	Φ x Ht cm	Sur.	Prix HT
-------------	-----	------	-----------	------	---------

Gin	5	75 05 037	4,8 x 5,7	288	0,97
	3,5	75 05 020	4,2 x 5,2	24	0,90
Salto	6,5	75 06 108	4,8 x 6,6	48	1,55
Baril	16	75 05 006	5,7 x 8	48	1,08



Islande



Vigne



Hot shot

Désignation	Ccl	Code	Φ x Ht cm	Sur.	Prix HT
-------------	-----	------	-----------	------	---------

Islande	6,5	75 06 493	3,8 x 10,5	12/72	0,99
Vigne	6	75 06 146	3,8 x 10,5	48	1,31
Hot shot	7	75 05 066	5,5 x 8,5	48	1,55
	3,4	75 05 065	4,5 x 7	24	1,40



Conique



Stack-up



Granity

Désignation	Ccl	Code	Φ x Ht cm	Sur.	Prix HT
-------------	-----	------	-----------	------	---------

Conique	8	75 05 004	5 x 7,8	48	1,10
Stack-up	4,5	75 07 239	5 x 6	48	1,35
Granity	4,5	75 07 093	5 x 5,7	48	1,31



Shetland



Eskale

Désignation	Ccl	Code	Φ x Ht cm	Sur.	Prix HT
-------------	-----	------	-----------	------	---------

Shetland	15	75 06 069	7 x 9	48	1,81
	9	75 06 068	6 x 7,3	48	1,51
Eskale	18	75 15 287	7,7 x 7,8	24	1,91
	9	75 15 288	6,2 x 6,4	24	1,75



Stockholm



Véga

Désignation	Ccl	Code	Φ x Ht cm	Sur.	Prix HT
-------------	-----	------	-----------	------	---------

Stockholm	4,5	75 05 024	4,3 x 5,2	48	0,97
Véga	4	75 16 380	5 x 3,8	24	1,32



New York shot non trempé

Désignation	Ccl	Code	Φ x Ht cm	Sur.	Prix HT
-------------	-----	------	-----------	------	---------

New York (3 motifs assortis)	3,4	75 07 338	4,4 x 5,5	24	1,23
---------------------------------	-----	-----------	-----------	----	------

## Juliet - Grès et Acacia



Blanche

Bleu

Perle

Amande

Jaune

Paprika

Kaki

Désignation	Code	Ccl	Φ x Ht cm	Sur.	Prix HT
Blanche	79 12 019	47,5	9-14 x 14	6	9,85
	79 12 168	30	9-12,5 x 11	6	8,50
Bleu	79 12 015	47,5	9-14 x 14	6	9,95
	79 12 167	30	9-12,5 x 11	6	8,50
Perle	79 12 014	47,5	9-14 x 14	6	9,95
	79 12 166	30	9-12,5 x 11	6	8,50
Amande	79 12 013	47,5	9-14 x 14	6	9,95
	79 12 165	30	9-12,5 x 11	6	8,50

Désignation	Code	Ccl	Φ x Ht cm	Sur.	Prix HT
Jaune	79 12 030	47,5	9-14 x 14	6	9,85
	79 12 169	30	9-12,5 x 11	6	8,50
Paprika	79 12 032	47,5	9-14 x 14	6	9,85
	79 12 170	30	9-12,5 x 11	6	8,50
Kaki	79 12 034	47,5	9-14 x 14	6	9,85
	79 12 171	30	9-12,5 x 11	6	8,50



## 2 FORMATS

Tisanières en grès coloré : 30 et 47,5 cl pour des moments de dégustation adaptés à vos envies, alliant style et praticité.



## Enzo - Porcelaine



**Théière Enzo 68 cl**  
avec couvercle bois d'hêtre et infuseur inox

Désignation	Code	Ccl	Φ x Ht cm	Sur.	Prix HT
Théière Enzo	79 12 045	68	18-11,5 x 12	6	16,85

## Mona - Porcelaine



**Théière en Mona porcelaine**  
avec couvercle bois d'hêtre et infuseur inox

Désignation	Code	Ccl	Φ x Ht cm	Sur.	Prix HT
Théière Mona	79 12 106	100	22 x 14 x 13	6	18,50

## Hôtellerie - Porcelaine



Wersal



Ameryka

Désignation	Code	Ccl	Φ x Ht cm	Sur.	Prix HT
Wersal	26 91 275	60	22 x 9	12	14,23
Ameryka	26 91 074	40	16 x 10	12	13,26



Pichet à anse renforcée

Désignation	Code	Ccl	Φ x Ht cm	Sur.	Prix HT
Pichet à anse	29 40 434	75	8,5-13 x 13	2	13,50
	29 40 433	50	8-12 x 11,5	6	10,85
	29 40 436	30	10,5 x 7,5 x 10	6	8,35
	29 40 432	12	7,5 x 8	4	2,00

**Viggo**
**Paprika****Jaune****Bleu****Amande****Noir**

Désignation	Code	Ccl	L x l x Ht cm	Sur.	Prix HT
Paprika	79 12 175	100	20 x 15 x 13,5	6	28,95
	79 12 180	50	17 x 12 x 11,3	6	21,80
Jaune	79 12 176	100	20 x 15 x 13,5	6	28,95
	79 12 181	50	17 x 12 x 11,3	6	21,80
Bleu	79 12 177	100	20 x 15 x 13,5	6	28,95
	79 12 182	50	17 x 12 x 11,3	6	21,80

Désignation	Code	Ccl	Φ x Ht cm	Sur.	Prix HT
Amande	79 12 178	100	20 x 15 x 13,5	6	28,95
	79 12 183	50	17 x 12 x 11,3	6	21,80
Noir	79 12 179	100	20 x 15 x 13,5	6	28,95
	79 12 184	50	17 x 12 x 11,3	6	21,80

**COUVERCLE BOIS****FILTRE INOX**

Infuseur micro-perforé : saveurs optimales.

**MANCHE BOIS****FONTE D'ACIER**

La fonte d'acier préserve élégamment la chaleur, alliant durabilité et style.



Théière compatible tous feux, dont induction

## Théières en fonte

**FILTRE AMOVIBLE**

Équipée d'un infuseur amovible en acier inoxydable pour le thé en vrac. Facile à nettoyer.

**Osaka Théière en fonte noire  
Grand format 1,5L****Fuji Théière en fonte bleue 80cl**

Désignation	Code	Ccl	Φ x Ht cm	Sur.	Prix HT
Osaka grand format	73 21 423	150	20 x 12,5	4	26,50
Osaka moyen format	73 21 528	120	14 x 10,5	4	22,50
Fuji	73 21 629	80	18 x 10,5	4	22,50

**New products  
Nouveautés**

Laska



Ambre Gris Vert

Coloris	Code	Ccl	Φ x Ht cm	Sur.	Prix HT
Ambre	79 12 215	45	11 x 13	6	12,95
Gris	79 12 216	45	11 x 13	6	12,95
Vert	79 12 217	45	11 x 13	6	12,95

Hera - Lot de 2



Tasses 35cl

Tasses 25cl

Désignation	Code	Ccl	Φ x Ht cm	Sur.	Prix HT
Tasses (x2)	79 12 227	35	8 x 12	8	9,30
	79 12 226	25	8 x 9,5	8	7,40
	79 12 225	12	6,5 x 7,3	8	5,30

Leia - Lot de 2



Tasses 35cl

Tasses 25cl

Désignation	Code	Ccl	Φ x Ht cm	Sur.	Prix HT
Tasses (x2)	79 12 232	35	7 x 11 x 11	8	6,90
	79 12 231	25	6,5 x 10 x 10	8	6,10
	79 12 230	10	6 x 8 x 5	8	3,90

Gustave



Carafe Viktor, double paroi couvercle infuseur



Théière Oscar infuseur en verre

Désignation	Code	Ccl	Φ x Ht cm	Sur.	Prix HT
Carafe Viktor	79 12 052	65	10 x 21,5	24	16,50
Théière Oscar	79 12 001	55	13 x 14	6	12,50



Théière 68cl

Théière 120cl

Carafe infuseur

Désignation	Code	Ccl	Φ x Ht cm	Sur.	Prix HT
Théière	79 12 102	68	19 x 12	6	14,50
	79 12 104	100	25 x 13	6	18,50
	79 12 099	120	9 x 18,5 x 18	6	21,50
	79 12 050	150	10 x 27	6	24,95



Théière Mugi 90cl couvercle en acacia



Théière Sofia 50cl couvercle en acacia

Désignation	Code	Ccl	Φ x Ht cm	Sur.	Prix HT
Théière Mugi	79 12 208	90	15 x 14	6	20,79
Théière Sofia	79 12 107	50	18 x 15	6	18,50



Tisanière

Tisanière simple paroi

Tisanière double paroi

Désignation	Code	Ccl	L x l x Ht cm	Sur.	Prix HT
Tisanière	79 12 103	30	9 x 12 x 10	12	6,85
Simple paroi	79 12 005	45	8,5 x 13 x 13	12	7,75
Double paroi	79 12 004	10	9,1 x 13 x 12,512		9,95

**Karl**



**Théière solitaire**

**Pichet 2L**

Désignation	Code	Ccl	L x l x Ht cm	Sur.	Prix HT
Théière solitaire	79 12 198	40	18 x 19 x 9,5	6	41,62
Pichet Karl	79 12 220	200	12,5 x 16,7 x 25	6	39,29



**Lot 2 Tasses 25cl**

Désignation	Coloris	Code	Φ x Ht cm	Sur.	Prix HT
Tasses (x2)	Blanc	79 12 195	8 x 10,6	6	6,45
	Gris	79 12 196	8 x 10,6	6	6,45



**Théières 55cl**



**Théières 1,2L**



**Tisanière 30cl**



**Tisanière 45cl**

Désignation	Coloris	Code	L x l x Ht cm	Sur.	Prix HT
Théière 55cl	Ambre	79 12 200	18 x 10 x 13,5	6	14,95
	Gris	79 12 201	18 x 10 x 13,5	6	14,95
	Vert	79 12 202	18 x 10 x 13,5	6	14,95
Théière 1,2L	Ambre	79 12 205	11 x 20 x 16,5	6	19,95
	Gris	79 12 206	11 x 20 x 16,5	6	19,95
	Vert	79 12 207	11 x 20 x 16,5	6	19,95

Désignation	Coloris	Code	Φ x Ht cm	Sur.	Prix HT
Tisanière 30cl	Ambre	79 12 185	12,5 x 9 x 10	6	8,50
	Gris	79 12 186	12,5 x 9 x 10	6	8,50
	Vert	79 12 187	12,5 x 9 x 10	6	8,50
Tisanière 45cl	Ambre	79 12 190	12,5 x 9 x 13	6	9,85
	Gris	79 12 191	12,5 x 9 x 13	6	9,85
	Vert	79 12 192	12,5 x 9 x 13	6	9,85



## Infuseurs



**A. Infuseur tube en verre Ycare**



**B. Infuseur Gaspard**



**C. Infuseur Oscar anse et socle acacia, panier inox, couvercle silicone**



**D. Infuseur Luke panier inox, couvercle acacia**



**E. Infuseur Sven couvercle bois**



**F. Boule à thé inox**

Désignation	Code	Φ x Ht cm	Sur.	Prix HT
A. Ycare	79 12 048	3 x 13,5	24	5,25
B. Gaspard	79 12 047	5,8 x 3,5 x 14	12	8,25
C. Oscar	79 12 018	4,8 x 14,5	20	5,95

Désignation	Code	Φ x Ht cm	Sur.	Prix HT
D. Luke	79 12 017	5,5-7 x 10	20	9,85
E. Sven	79 12 060	6,6 x 4,5 x 9	12	4,55
F. Boule à thé	50 41 046	4,5 x 4,5	48	1,78

## Moulins café à manivelle



**Moulin à café naturel**



**Moulin à café Isaak**



**Moulin à café Auguste**

Désignation	Code	L x l x Ht cm	Sur.	Prix HT
Naturel	79 11 161	9,5 x 6,5 x 17,7	6	21,50
Auguste	79 11 151	20,5 x 11,5 x 24	4	34,95
Isaak	79 11 150	4,8 x 13	6	10,50



## Cafetière à piston



**Cafetière à piston Keygo**



**Cafetière à piston Helya**

Désignation	Code	Ccl	Φ x Ht cm	Sur.	Prix HT
Keygo	79 12 055	130	10 x 17,5 x 21,5	6	21,50
Helya	79 12 002	80	15 x 23	6	21,50

## Accessoires



**Pot à verser empilable inox 18.10**



**Porte filtre**

Désignation	Code	Φ x Ht cm	Sur.	Prix HT
Pot inox 18.10	47 37 012	200 14 x 17,5	6	33,03
	47 37 011	150 12 x 16,5	6	29,68
	47 37 010	100 11 x 14,5	6	24,84
Porte filtre	54 20 325	7,5 x 15	12	2,45

 **New products**  
Nouveautés

## Service à thé et café



Tasse et soucoupe Aroma



Tasse et soucoupe Voluto



Mug Voluto

Désignation	Code	Ccl	Φ x Ht cm	Sur.	Prix HT
Tasse Aroma	75 51 353	22	10 x 8,5	48	4,17
scp	75 51 360		14 x 2,1	48	3,28
	75 51 352	8	7,6 x 6,4	48	3,01
scp	75 51 359		12 x 1,9	48	2,81
Tasse Voluto	75 52 122	22	10,7 x 7,1	24	1,67
scp	75 51 360		14 x 2,1	48	3,28
	75 52 125	9	8,4 x 6,8	24	1,58
scp	75 51 359		12 x 1,9	48	2,81
Mug Voluto	75 52 126	40	11 x 12,3	24	2,60
	75 52 124	32	10,6 x 11	24	1,96
	75 52 123	25	10,4 x 9,1	24	1,73



Lot de 2 chopes macchiato



Lot de 2 mugs



Lot de 2 tasses à thé

Désignation	Code	Ccl	Φ x Ht cm	Sur.	Prix HT
Macchiato	75 36 408	34	8,9 x 15	6	16,61
Mugs (x2)	16 15 501	29,5	8 x 11,8	6	16,87
	16 15 500	12	8 x 7	6	13,47
Tasse à thé	16 15 502	38,5	11,3 x 8,6	6	23,25



Lot de 2 Ametista



Lot de 2 Cylindrical



Lot de 2 Caféino



Lot de 2 chopes juice

Désignation	Code	Ccl	Φ x Ht cm	Sur.	Prix HT
Ametista	16 15 513	11	8,6 x 8,1	6	7,92
Cylindrical	16 15 510	11	6,2 x 6,9	6	7,92
Caféino	75 36 406	8,5	6,2 x 7,4	6	8,86
Chope juice	75 36 407	27	8,2 x 11,3	6	14,47



Mug versaille empilable trempé



Bock thé non trempé



Mug basic



Caféino



Lot de 6 verre à thé Ceylan (3 décors assortis)

Désignation	Code	Ccl	Φ x Ht cm	Sur.	Prix HT
Versaille	13 10 018	26	7 x 9	6	1,67
Bock	75 50 524	23	7 x 10,5	24	3,01
Mug	75 41 105	35	12 x 9,5	24	2,36
Caféino	75 30 035	8,5	5,9 x 7,1	48	0,97
Ceylan (x6)	16 11 493	10	5 x 7,8	8	6,50

## Riga

novastyl



Théière Riga avec infuseur et couvercle en acacia

Désignation	Code	Ccl	Φ x Ht cm	Sur.	Prix HT
Théière	30 20 340	100	9,5 x 16 x 17	4	17,90



Mug Riga

Désignation	Coloris	Code	Ccl	Φ x Ht cm	Sur.	Prix HT
Mug	Bleu	30 20 325	44	9,5-13,5 x 10	6	3,15
	Beige	30 20 326	44	9,5-13,5 x 10	6	3,15
	Marron	30 20 327	44	9,5-13,5 x 10	6	3,15
	Amande	30 20 328	44	9,5-13,5 x 10	6	3,15



Bol Riga

Tasse Riga

Désignation	Coloris	Code	Ccl	Φ x Ht cm	Sur.	Prix HT
Bol	Bleu	30 20 330	57	14 x 7	6	3,35
	Beige	30 20 331	57	14 x 7	6	3,35
	Marron	30 20 332	57	14 x 7	6	3,35
	Amande	30 20 333	57	14 x 7	6	3,35
Tasse	Bleu	30 20 336	11	6,2 x 6,2	6	1,55
	Marron	30 20 335	11	6,2 x 6,2	6	1,55

## Tasses en porcelaine

## Café gourmand



Tasse Paula et sous-tasse

Code	Ccl	L x l x Ht cm	Sur.	Prix HT
26 91 415	20	8,6-11 x 7	6	3,92
scp 26 91 416		14 x 1,7	6	2,65
26 91 410	7	6,2-8,2 x 6	6	3,06
scp 26 91 411		12 x 1,5	6	1,94



Paire tasse Alaska

Code	Ccl	L x l x Ht cm	Sur.	Prix HT
26 30 373	22	7,5-9 x 8,2	6	3,67
scp		14,5		

Paire tasse Metropolitan  
(Boîte de 6)

Code	Ccl	L x l x Ht cm	Sur.	Prix HT
26 30 867	10	6,5 x 5,5	6	13,50
26 30 868	20	8,3 x 7,5	6	16,50

novastyl



Plateau Paula

Code	Ccl	L x l x Ht cm	Sur.	Prix HT
Plateau Paula				
26 91 420		20 x 13 x 2,3	6	7,48
Tasses compatibles				
26 91 415	20	8,6-11 x 7	6	3,92
26 91 410	7	6,2-8,2 x 6	6	3,06



Tasse Wersal et sous-tasse

Code	Ccl	L x l x Ht cm	Sur.	Prix HT
26 91 271	20	9,3-12 x 5,6	24	3,86
26 91 270		14,5 x 1,8	24	2,43



Hel bol empilable et sous-tasse

Code	Ccl	L x l x Ht cm	Sur.	Prix HT
26 91 068	32	10,5 x 6	6	6,90
scp 26 91 067		16 x 2,4	12	1,89



Tasse Boule empilable et sous-tasse

Code	Ccl	L x l x Ht cm	Sur.	Prix HT
29 40 332	20	9-11 x 6,5	12	4,65
scp 29 40 333		14,5 x 1,8	12	2,36
29 40 330	8	6,2-8 x 5,5	12	3,65
scp 29 40 331		12 x 1,5	12	1,99



Tasse Nadia et sous-tasse

Code	Ccl	L x l x Ht cm	Sur.	Prix HT
26 91 216	22	9,6-12 x 5,6	12	3,92
scp 26 91 217		16 x 1,8	12	2,65
26 91 214	10	7-8,8 x 5,8	12	3,57
scp 26 91 215		13,5 x 1,5	12	2,17



Tasse Hel empilable et sous-tasse

Code	Ccl	L x l x Ht cm	Sur.	Prix HT
26 91 066	25	9,5-12 x 6	12	4,15
scp 26 91 067		16 x 2,4	12	1,89
26 91 064	20	8,5-11 x 6	12	2,90
scp 26 91 065		15 x 2,3	12	2,17
26 91 062	15	8-10 x 6	12	2,76
scp 26 91 063		13,5 x 2	12	1,94
26 91 060	9	5,8-8 x 6	12	2,57
scp 26 91 061		12 x 1,8	12	1,62



Tasse Ambassador et sous-tasse

Code	Ccl	L x l x Ht cm	Sur.	Prix HT
26 15 084	20	8-10,5 x 6	6	3,43
scp 26 15 085		16 x 1,8	6	1,91
26 15 080	10	6-7,8 x 5	6	2,01
scp 26 15 081		12,5 x 1,6	6	1,38



Tasse Empilable standard et sous-tasse

Code	Ccl	L x l x Ht cm	Sur.	Prix HT
29 40 114	20	7-9,4 x 7,2	6	1,45
scp 29 40 115		14 x 1,8	6	1,35
29 40 110	9	5,5-7,3 x 6,2	6	1,45
scp 29 40 111		12,6 x 1,7	6	1,35

## Urus - Porcelaine



Tasse 21cl

Soucoupe

Désignation	Coloris	Code	Ccl	Φ x Ht cm	Sur.	Prix HT
Tasse	Bleu	79 32 182	21	9,2 x 6,5	6	5,50
	Beige	79 32 197	21	9,2 x 6,5	6	5,50
	Bleu	79 32 180	9	6,7 x 5,2	6	4,50
	Beige	79 32 195	9	6,7 x 5,2	6	4,50
Soucoupe	Bleu	79 32 183		15 x 1,8	6	4,50
	Beige	79 32 198		15 x 1,8	6	4,50
	Bleu	79 32 181		12 x 1,7	6	4,50
	Beige	79 32 196		12 x 1,7	8	4,50



Bol 10cl

Bol 24cl

Bol 80cl

Désignation	Coloris	Code	Ccl	Φ x Ht cm	Sur.	Prix HT
Bol	Bleu	79 32 184	10	8 x 4,5	12	3,95
	Beige	79 32 199	10	8 x 4,5	12	3,95
	Bleu	79 32 205	11	8 x 5	12	3,95
	Bleu	79 32 185	24	10 x 5,7	12	5,50
	Beige	79 32 200	24	10 x 5,7	12	5,50
	Bleu	79 32 206	80	18 x 5	4	12,95
	Beige	79 32 207	80	18 x 5	4	12,95

## Aronal & Boral - Grès



Mug 45cl Aronal

Bol 50cl Aronal

Bol 50cl Boral

Désignation	Code	Ccl	Φ x Ht cm	Sur.	Prix HT
Mug	79 32 084	45	12,5 x 8,5 x 10,5	6	3,25
Bol	79 32 243	50	17 x 6	6	4,95
Bol	79 32 253	50	17 x 6	6	4,95



## Ora - Porcelaine



Tasse 16cl

Mug 32cl

Désignation	Code	Ccl	Φ x Ht cm	Sur.	Prix HT
Tasse	79 32 361	16	7,5 x 6,5	4	3,95
Mug	79 32 362	32	9,2 x 10	4	5,95



Bock empilable - Grès

Mug White - Porcelaine

Désignation	Code	Ccl	L x l x Ht cm	Sur.	Prix HT
Bock empilable	29 40 117	25	7,7-10,4 x 8,7	6	1,35
Mug White	29 40 119	35	8,2-11,7 x 10,2	6	2,15

## Vita - Céramique



Tasse 18cl

Jumbo 50cl



Mug 34cl

Bol 64cl

Désignation	Coloris	Code	Ccl	Φ x Ht cm	Sur.	Prix HT
Tasse	Ivoire	30 20 283	18	7,3 x 8	6	1,35
	Gris	30 20 294	18	7,3 x 8	6	1,35
Mug	Ivoire	30 20 284	34	8,5 x 10,2	6	1,45
	Gris	30 20 295	34	8,5 x 10,2	6	1,45
Jumbo	Ivoire	30 20 285	50	11,5 x 8,2	6	2,10
	Gris	30 20 296	50	11,5 x 8,2	6	2,10
Bol	Ivoire	30 20 286	64	14,6 x 8	6	2,10
	Gris	30 20 297	64	14,6 x 8	6	2,30

Grès



Oli  
p.96



Nova  
p.97



Aronal  
p.98



Boral  
p.99



Katanga  
p.100



Grenada  
p.100

Porcelaine



Urus  
p.88-91



Ora  
p.92



Sigma  
p.93



Vénus  
p.94



Saturne  
p.95



Volcano  
p.95

Porcelaine



Omega  
p.102



Thera  
p.103



Delta  
p.104-105



Mellow  
p.106-107



Reckless  
p.108-109



Tiffany  
p.110

Porcelaine



Modest  
p.111



Lagoon Ocean  
p.112-113



Alhambra  
p.114



Albus  
p.115



East White  
p.116



Viento  
p.117

Porcelaine



Luca Mozaic  
p.118



Lunar Ocean  
p.119



Hornfels  
p.120



Aura Space  
p.121



Aura Passion  
p.121



Atome  
p.122

Porcelaine



Nuance  
p.123



Palmeraie  
p.124



Spirale  
p.124



Botanic  
p.125



Byzance  
p.126



Maka  
p.126

Porcelaine



Lachat  
p.127



Natura  
p.127



Jasmin  
p.128



Aqua  
p.128



Savane  
p.129



Dune  
p.129

Porcelaine



Jaipur  
p.130



Héraclée  
p.130



Jade  
p.131



Ambre  
p.131



Floralis  
p.132



Faustine  
p.132

Porcelaine

Faïence

Porcelaine Blanche



Charlotte  
p.133



Capria  
p.134



Amatxi  
p.135



White  
p.136



Metropolitan  
p.137



Alaska  
p.137

Porcelaine Blanche



Ambassador  
p.138



Polo  
p.138



Carré Hôtel  
p.139



Classic Filet or  
p.140



Carbone  
p.140



Wersal  
p.142

Porcelaine Blanche

Spécifiques



Roma  
p.142



Martelé  
p.143



Risotto  
p.143



Pasta  
p.144



Pizza  
p.144



Inclinés  
p.144

Spécifiques

Porcelaine Vitriifiée



Compartment  
p.144



Creuses/Coupes  
p.145



Saladiers  
p.145



Carpaccio  
p.146



Steak  
p.146



Oslo  
p.147

Opal



Autonomy  
p.148



Heat System  
p.148



Nova Aquitana  
p.148



Restaurant Filet  
p.149



Restaurant Uni  
p.149



Brush  
p.149

Opal



Evolutions Black  
p.150



Stairo  
p.151



Feston  
p.151



Génération  
p.152



Picardie  
p.152



Saladiers  
p.153

Verre

Mélatine



Kuwae  
p.154



Rivage  
p.154



Plat en Verre  
p.152



Saladier Inox  
p.154



Bols  
p.156



Ramequins  
p.157

Compléments

Compléments



Coupes en verre  
p.158-159



Mises en bouche  
p.160-161



Service à thé  
p.162-165



Service à café  
p.166



Petit Déjeuner  
p.167



Tasses en porcelaine  
p.168-169

## La cuisson



New products  
Nouveautés 2026



### Trinox Revêtu

Une gamme en acier inoxydable dotée d'un revêtement céramique nid d'abeille, alliant résistance et performance de cuisson.



### Alu Pro

Une collection professionnelle en aluminium dotée d'un revêtement céramique haute performance



New products  
Nouveautés 2026

Le Parfait



### Easynox

Une collection en aluminium et inox, déclinée dans des teintes douces Brume, Écume et Corail, alliant légèreté et performance de cuisson au quotidien.



### Bocal Bistrot Le Parfait

Un bocal idéal pour une conservation optimale, disponible en différentes tailles.



# 03

## CUISSON



- Acier Inoxydable 176 à 185
- Aluminium 186 à 191
- Fonte Émaillée 194
- Tajines et Couscous 195 à 196
- Émail 197
- Cuisson au four - Grès 198
- Cuisson au four - Acier carbone 199 à 201
- Bacs gastronomiques 202 à 203
- Cuisson au four - Verre 204 à 208
- Storage 209 à 215
- Matériel électrique 216 à 219

# Triply



## TRIPLY,

La collection made in France pour les professionnels de la restauration !



CUISSON



## Durabilité & ROBUSTESSE



## CUISSON PRO, SAINE & DURABLE

Sans substances nocives, précise et rapide grâce à la technologie 3 couches :



**GRADUATIONS**  
Jauger rapidement la capacité

**BORD VERSEUR**  
Simplifier le versement

**1 COUCHE INTÉRIEURE**  
INOX 304  
0,4mm

**2 COUCHE INTERMÉDIAIRE**  
ALUMINIUM  
1mm

**3 COUCHE EXTÉRIEURE**  
INOX 430  
0,6mm

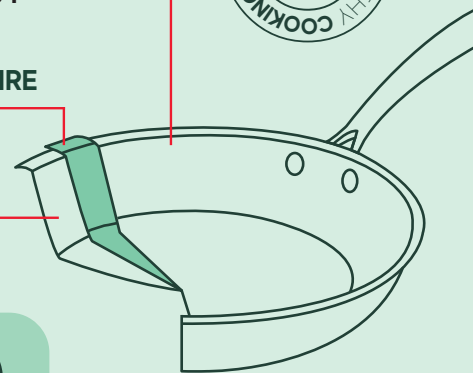

Four



Gaz



Électrique



Vitro-céramique



Induction

# Triply

## LA COLLECTION

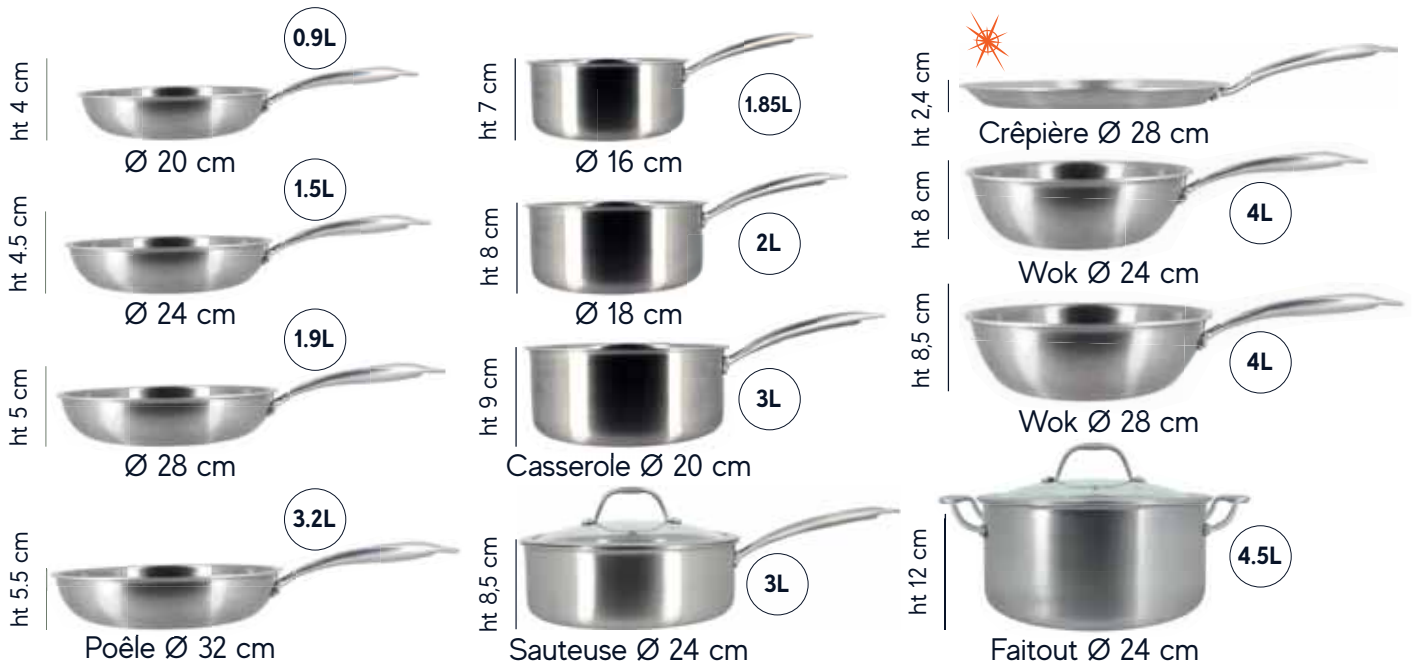

Désignation	Litres	Code	Φ x Ht cm	SUR.	Prix HT
Poêle	0,9	60 20 485	20 x 4	6	26,63
	1,5	60 20 486	24 x 4,5	6	29,51
	1,9	60 20 487	28 x 5	6	33,94
	3,2	60 20 488	32 x 5,5	6	41,05
Casserole	1,85	60 20 489	16 x 7	6	25,59
	2	60 20 490	18 x 8	6	28,68
	3	60 20 491	20 x 9	6	31,88

Désignation	Litres	Code	Φ x Ht cm	SUR.	Prix HT
Sauteuse	3	60 20 529	24 x 8,5	4	40,90
Wok	4	60 20 519	24 x 8	4	35,90
	4	60 20 492	28 x 8,5	4	38,51
Faitout	4,5	60 20 518	24 x 12	4	54,85
Crêpière		60 20 534	28 x 2,4	6	37,65



New products  
Nouveautés

Acier Inoxydable

**Trinox** 



**TRINOX,**  
L'inox triple couche  
haute résistance



CUISSON



Désignation	Litres	Code	Φ x Ht cm	SUR.	Prix HT
Poêle	1,5	60 20 145	24 x 4,5	6	13,50
	1,9	60 20 146	28 x 5	6	14,95
	2,7	60 20 147	30 x 5	6	16,05
Casserole	2	60 20 148	18 x 9	6	13,25
	3	60 20 149	20 x 10	6	14,95

Désignation	Litres	Code	Φ x Ht cm	SUR.	Prix HT
Faitout	3	60 20 151	20 x 10	6	24,75
	4,5	60 20 152	24 x 12	6	26,40

### 3 COUCHES TRI-PLY

**1 COUCHE EXTÉRIEURE**  
INOX 430 0,6mm

**2 COUCHE INTERMÉDIAIRE**  
ALUMINIUM 1mm

**3 COUCHE INTÉRIEURE**  
INOX 304 0,4mm



Four



Gaz



Électrique



Vitro-céramique



Induction

**POIGNÉE CHEF**  
Non conductrice  
de la chaleur

Trinox Revêtu

## TRINOX REVÊTU,

L'inox triple couche haute résistance, associé à un revêtement céramique performant

**1**  
COUCHE EXTÉRIEURE  
INOX 430 0,6mm

**2**  
COUCHE INTERMÉDIAIRE  
ALUMINIUM 1mm

**3**  
COUCHE INTÉRIEURE  
INOX 304 0,4mm

**+** REVÊTEMENT  
CÉRAMIQUE  
NID D'ABEILLE  
Ultra résistant

**POIGNÉE CHEF**  
Non conductrice  
de la chaleur



Four



Gaz



Électrique



Vitro-  
céramique



Induction

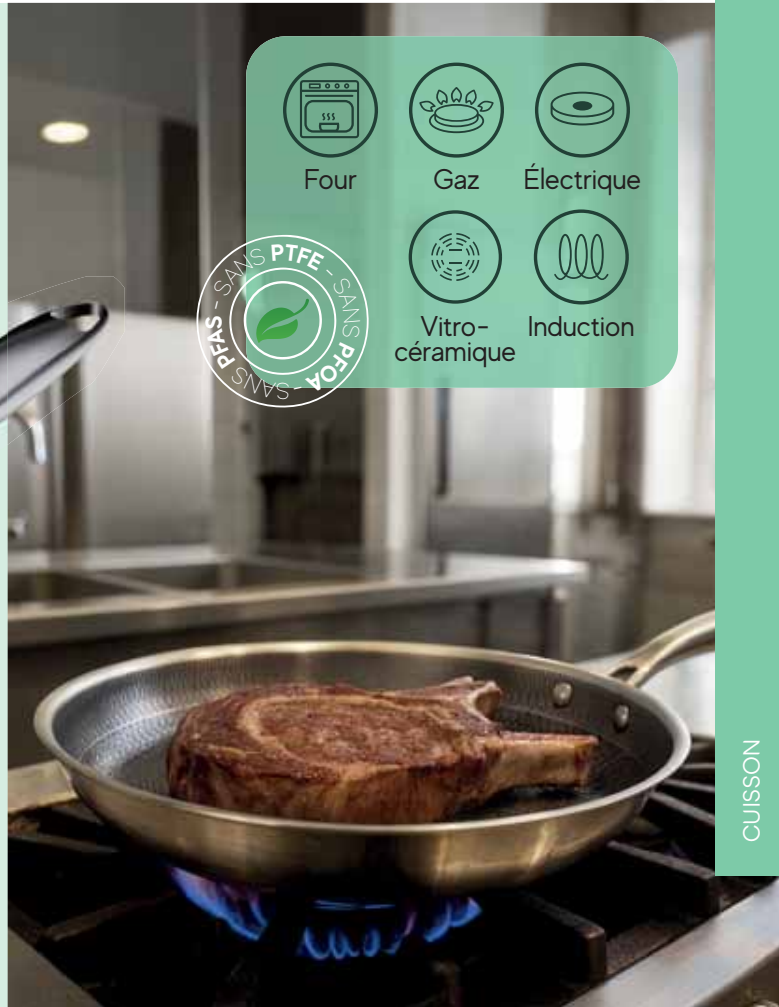

CUISSON



Désignation	Litres	Code	Φ x Ht cm	SUR.	Prix HT
Poêle	0,9	60 21 060	20 x 4,5	6	16,75
	1,5	60 21 061	24 x 4,5	6	17,95
	1,9	60 21 062	28 x 5	6	20,50
	2,7	60 21 063	30 x 5	6	22,85
Sauteuse	3	60 21 066	24 x 6,5	6	27,95
Casserole	1	60 21 064	14 x 7	6	16,85
	1,85	60 21 065	16 x 8	6	18,95

Désignation	Litres	Code	Φ x Ht cm	SUR.	Prix HT
Wok	4	60 21 067	28 x 8,5	3	23,95
Faitout	3	60 21 068	20 x 10	2	32,50
	4,5	60 21 069	24 x 12	2	41,95

New products  
Nouveautés

**INOX PRO,**

La qualité professionnelle,  
robuste et durable !

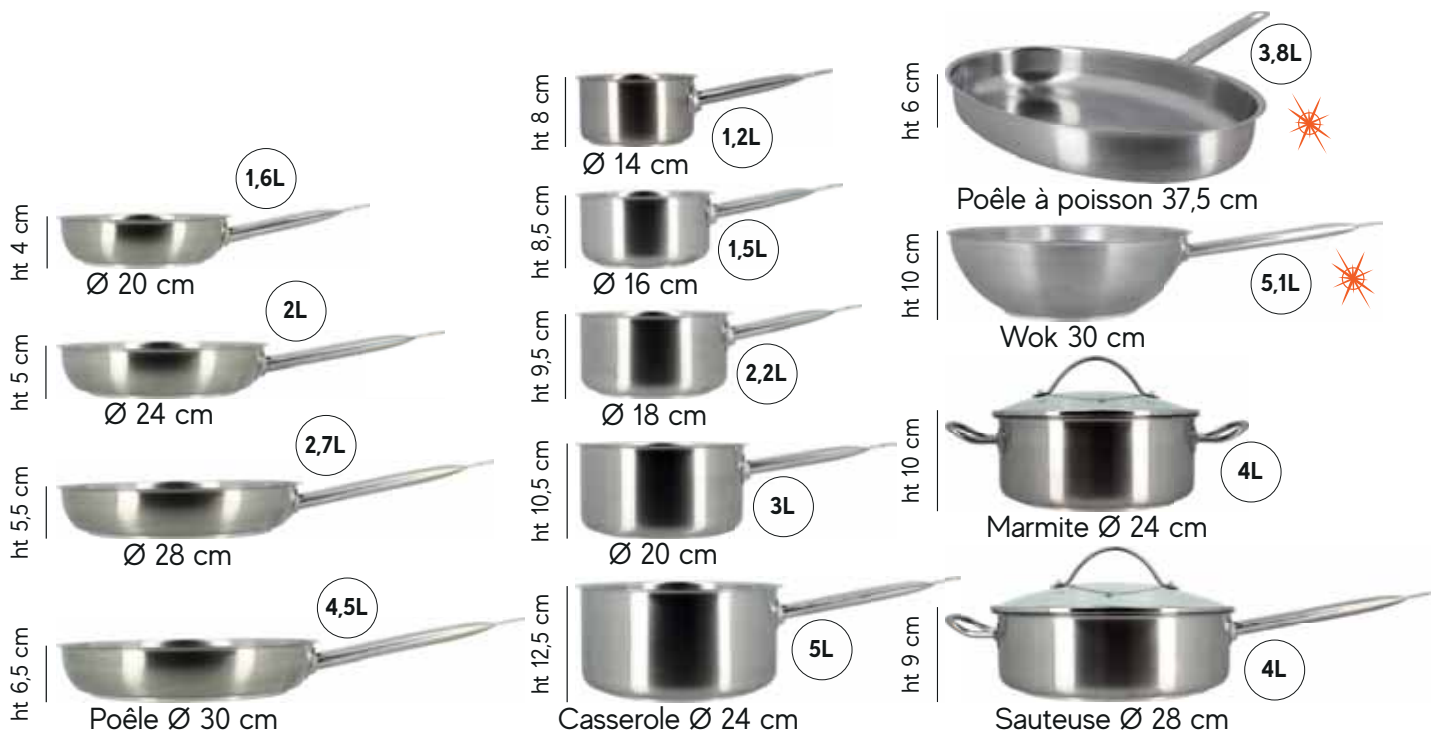

Désignation	Litres	Code	Φ x Ht cm	SUR.	Prix HT
Poêle	1,6	75 20 060	20 x 4	6	16,85
	2	75 20 061	24 x 5	6	22,45
	2,7	75 20 062	28 x 5,5	6	24,55
	4,5	75 20 063	30 x 6,5	6	26,55
Casserole	1,2	75 20 001	14 x 8	6	13,55
	1,5	75 20 002	16 x 8,5	6	14,55
	2,2	75 20 003	18 x 9,5	6	16,85
	3	75 20 004	20 x 10,5	6	18,75
	5	75 20 005	24 x 12,5	4	27,25

Désignation	Litres	Code	Φ x Ht cm	SUR.	Prix HT
Poêle poisson	3,8	60 20 260	37,5 x 6	4	31,15
Wok	5,1	75 20 065	30 x 10	6	25,80
Marmite	2,7	75 20 038	24 x 10	4	38,85
Sauteuse	4,5	75 20 016	28 x 9	4	38,95

New products  
Nouveautés

# Inox pro



Four



Gaz



Électrique



Vitro-céramique



Induction

**POIGNÉE TUBULAIRE**  
Non conductrice de la chaleur

**3 COUCHE EXTÉRIEURE INOX 430**

**2 COUCHE INTERMÉDIAIRE ALUMINIUM**

**1 COUCHE INTÉRIEURE INOX 304**



Acier Inoxydable

**Easynox** 



**EASYNOX**  
L'INOX 304 FACILE



**ULTRA-LÉGÈRE  
NATURELLEMENT SAINE**



CUISON



**LA COLLECTION** Poignée fixe



Désignation	Litres	Code	Ø x Ht cm	SUR.	Prix HT
Poêle	1,2	60 21 001	20 x 4	6	12,55
	1,9	60 21 002	24 x 5,5	6	15,20
	2,9	60 21 003	28 x 5,5	6	17,85
Casserole	1,5	60 21 004	16 x 8	6	13,15
	2,1	60 21 005	18 x 8,5	6	15,30
	2,7	60 21 006	20 x 9,5	6	16,45

Désignation	Litres	Code	Ø x Ht cm	SUR.	Prix HT
Faitout	4,8	60 21 008	24 x 8	3	24,45
Wok	4,1	60 21 010	28 x 12,5	6	22,65

Le Meilleur  
des 2 mondes 

INOX   
Le choix santé



 **ALUMINIUM**  
La Cuisson homogène

2 **ACIER INOXYDABLE 304**  
Épaisseur 0,5 mm

3 **ALUMINIUM EFFET MAT**  
Épaisseur 1,5 mm

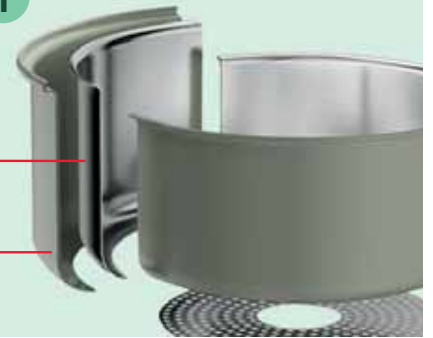

## LA COLLECTION

Amovible



## LA COMPOSITION



ht 5 cm



Ø 24 cm

ht 8,5 cm



Ø 18 cm

ht 5,5 cm



Poêle Ø 28 cm

ht 9 cm



Casserole Ø 20 cm



Four



Gaz



Électrique



Vitro-  
céramique



Induction

Désignation	Code	SUR.	Prix HT
Bleu vert	60 21 015	6	56,35
Corail	60 21 016	6	56,35
Ivoire	60 21 017	6	56,35



 New products  
Nouveautés

Iris Inox

**L'INOX**  
LE MEILLEUR CHOIX  
POUR UNE  
*Cuisson Saine*

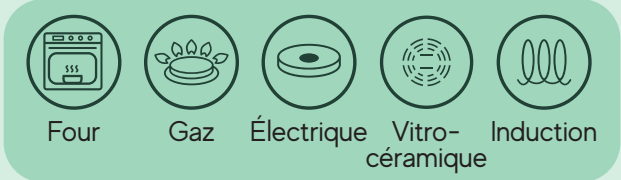

**1 ACIER INOXYDABLE 304**  
Épaisseur 0,5 mm

**2 ALUMINIUM**  
Fond sandwich renforcé



LA COLLECTION

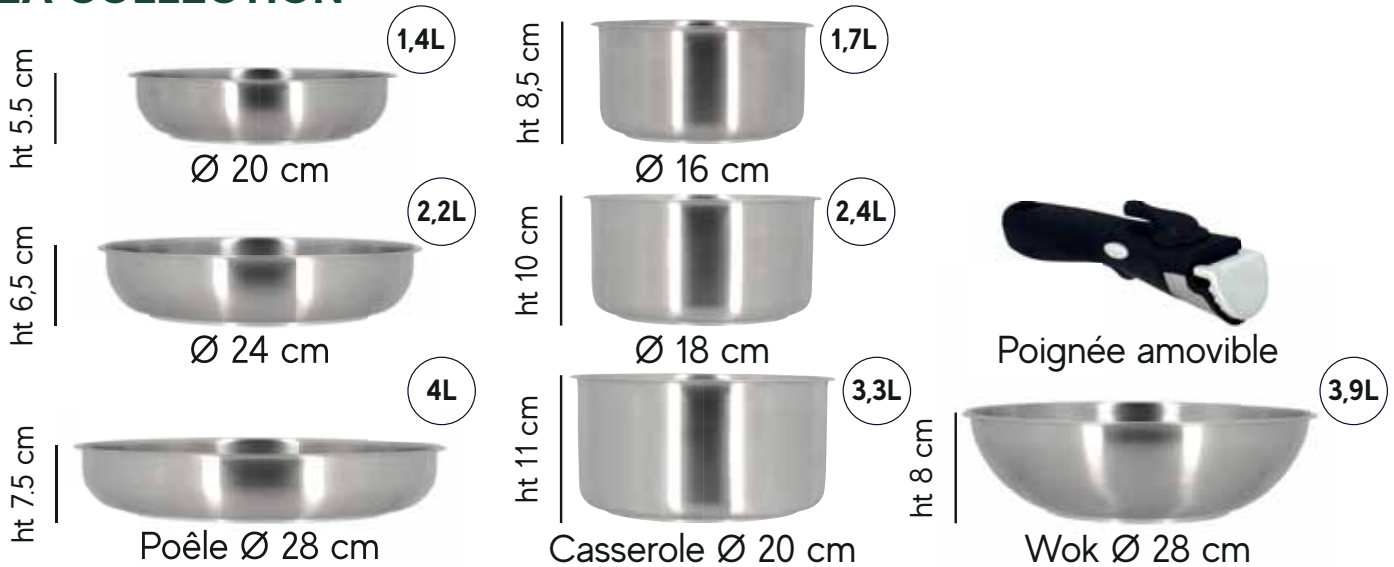

Désignation	Litres	Code	Φ x Ht cm	SUR.	Prix HT
Poêle	1,4	79 30 100	20 x 5,5	3	13,25
	2,2	79 30 101	24 x 6,5	3	16,65
	4	79 30 103	28 x 7,5	3	19,95

Désignation	Litres	Code	Φ x Ht cm	SUR.	Prix HT
Casserole	1,7	79 30 082	16 x 8,5	3	11,65
	2,4	79 30 083	18 x 10	3	13,65
	3,3	79 30 084	20 x 11	3	14,95
Wok	3,9	79 30 104	28 x 8	3	21,85

**CHALEUR INSTANTANÉE**  
en **30** Secondes !

**POIGNÉE AMOVIBLE**  
Double sécurité  
Pratique à utiliser



## First Inox

### FIRST INOX,

L'inox robuste, pratique et durable

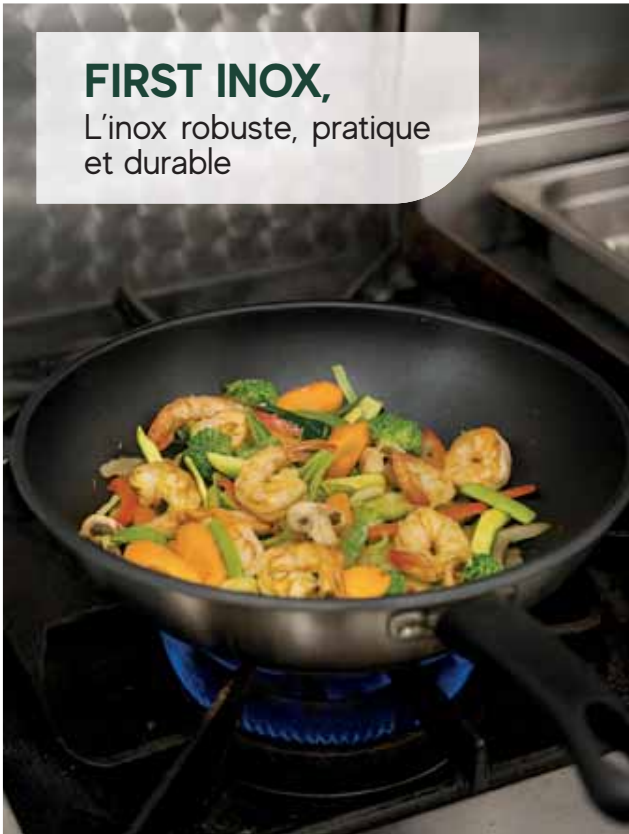

Gaz Électrique Vitro-céramique Induction

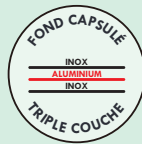

**POIGNÉE BAKÉLITE**  
Non conductrice de la chaleur

**1 REVÊTEMENT ANTI-ADHÉSIF**  
Xylan plus PPG pour les poêles  
2 couches



**2 ACIER INOXYDABLE 430**  
Épaisseur 0,4 mm

**3 FOND INDUCTION**  
Fond capsulé 5mm

## LA COLLECTION

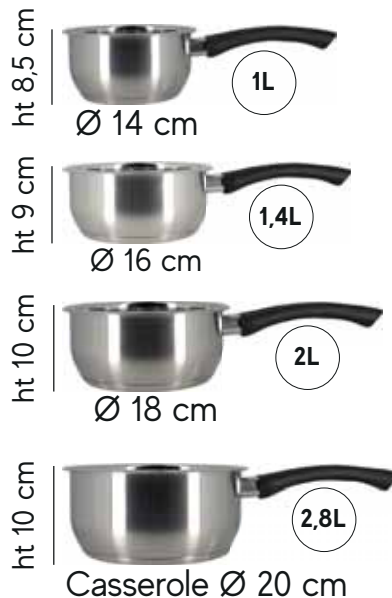
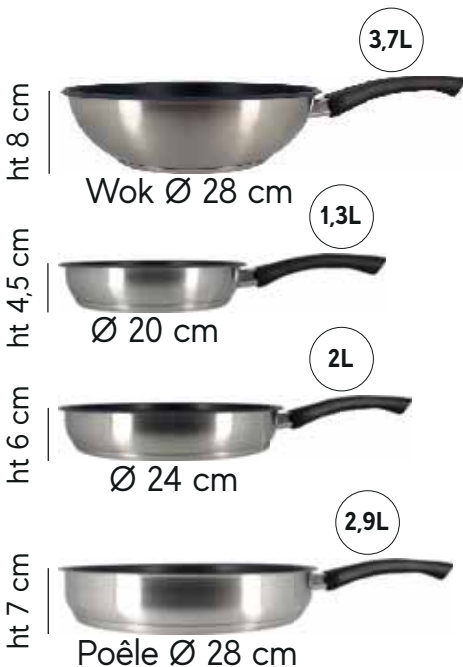

Désignation	Litres	Code	Φ x Ht cm	SUR.	Prix HT
Wok	3,7	60 20 252	28 x 8	3	16,55
Poêle	1,3	60 20 244	20 x 4,5	3	12,25
	2	60 20 246	24 x 6	3	14,35
	2,9	60 20 247	28 x 7	3	16,85

Désignation	Litres	Code	Φ x Ht cm	SUR.	Prix HT
Casserole	1	60 20 240	14 x 8,5	3	7,55
	1,4	60 20 241	16 x 9	3	8,25
	2	60 20 242	18 x 10	3	8,95
	2,5	60 20 243	20 x 10	3	9,85
Sauteuse	3	60 20 248	24 x 9	3	18,95
Faitout	2,8	60 20 255	20 x 9,5	2	14,25
	5	60 20 256	24 x 13	2	17,55

Aluminium

Alu pro



## ALU PRO,

L'aluminium professionnel haute performance, associé à un revêtement céramique performant

98% ALUMINIUM RECYCLÉ

1 COUCHE EXTÉRIEURE REVÊTEMENT NOIR

2 COUCHE INTERMÉDIAIRE ALUMINIUM PRESSÉ 4mm

3 COUCHE INTÉRIEURE CÉRAMIQUE DOUBLE COUCHE

+ POIGNÉE CHEF MÉTAL RIVETÉ  
Ultra résistante, non conductrice de la chaleur



CUISSON

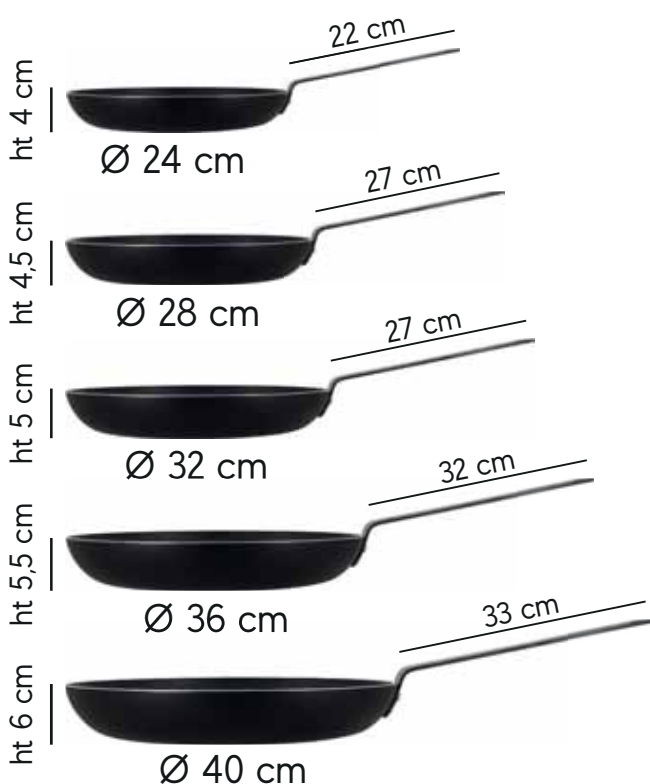

Désignation	Litres	Code	Ø x Ht cm	SUR.	Prix HT
Poêle	1,4	60 21 100	24 x 4	6	15,00
	2,3	60 21 101	28 x 4,5	6	18,60
	3,2	60 21 102	32 x 5	6	23,40
	4,6	60 21 103	36 x 5,5	6	28,20
	6	60 21 104	40 x 6	6	34,20



Four



Gaz



Électrique



Vitro-céramique



Induction

## First Alu

**98% ALUMINIUM RECYCLÉ**

**REVÊTEMENT CÉRAMIQUE**

Revêtement anti-adhésif, résistant et facile à nettoyer

**FOND TEXTURÉ**

Pour une meilleure adhérence des aliments pour une cuisson homogène

**POIGNÉE ERGONOMIQUE**

En bakélite soudée pour bonne prise en main



**FOND ALUMINIUM FORGÉ**  
Épaisseur 2 mm



**Faitout**

Code	Litres	Φ x Ht cm	SUR.	Prix HT
60 20 646	2,3	20 x 10	4	13,55
60 20 647	4,3	24 x 12	4	16,95



**Casserole**

**Poêle**

Code	Litres	Φ x Ht cm	SUR.	Prix HT
60 20 635	1	20 x 4,2	6	7,85
60 20 636	1,7	24 x 4,8	6	8,85
60 20 637	2,1	26 x 5	6	10,55
60 20 638	2,5	28 x 5	6	11,55
60 20 639	3,1	30 x 5,4	6	12,55

Code	Litres	Φ x Ht cm	SUR.	Prix HT
60 20 611	1,3	16 x 7,8	6	7,85
60 20 612	1,7	18 x 8	6	8,85
60 20 613	2,3	20 x 8,5	6	9,85



Gaz



Électrique



Vitro-céramique



Induction





Poêle

Désignation	Litres	Code	Φ x Ht cm	SUR.	Prix HT
● Rose	1,1	60 20 920	20 x 4,5	4	16,60
	1,8	60 20 921	24 x 5	4	20,80
	2,7	60 20 922	28 x 5,8	4	23,20
● Crème	1,1	60 20 845	20 x 4,5	4	16,60
	1,8	60 20 846	24 x 5	4	20,80
	2,7	60 20 847	28 x 5,8	4	23,20
● Safran	1,1	60 20 830	20 x 4,5	4	16,60
	1,8	60 20 831	24 x 5	4	20,80
	2,7	60 20 832	28 x 5,8	4	23,20
● Céladon	1,1	60 20 800	20 x 4,5	4	16,60
	1,8	60 20 801	24 x 5	4	20,80
	2,7	60 20 802	28 x 5,8	4	23,20
● Magenta	1,1	60 20 815	20 x 4,5	4	16,60
	1,8	60 20 816	24 x 5	4	20,80
	2,7	60 20 817	28 x 5,8	4	23,20
● Olive	1,1	60 20 875	20 x 4,5	4	16,60
	1,8	60 20 876	24 x 5	4	20,80
	2,7	60 20 877	28 x 5,8	4	23,20



Casserole

Désignation	Litres	Code	Φ x Ht cm	SUR.	Prix HT
● Rose	1,2	60 20 923	16 x 7,5	4	16,60
	1,8	60 20 924	18 x 8,5	4	19,95
	2,8	60 20 925	20 x 11	4	23,20
● Crème	1,2	60 20 848	16 x 7,5	4	16,60
	1,8	60 20 849	18 x 8,5	4	19,95
	2,8	60 20 850	20 x 11	4	23,20
● Safran	1,2	60 20 833	16 x 7,5	4	16,60
	1,8	60 20 834	18 x 8,5	4	19,95
	2,8	60 20 835	20 x 11	4	23,20
● Céladon	1,2	60 20 803	16 x 7,5	4	16,60
	1,8	60 20 804	18 x 8,5	4	19,95
	2,8	60 20 805	20 x 11	4	23,20
● Magenta	1,2	60 20 818	16 x 7,5	4	16,60
	1,8	60 20 819	18 x 8,5	4	19,95
	2,8	60 20 820	20 x 11	4	23,20
● Olive	1,2	60 20 878	16 x 7,5	4	16,60
	1,8	60 20 879	18 x 8,5	4	19,95
	2,8	60 20 880	20 x 11	4	23,20



Wok

Désignation	Litres	Code	Φ x Ht cm	SUR.	Prix HT
● Rose	3,7	60 20 929	28 x 8	4	23,00
● Crème	3,7	60 20 854	28 x 8	4	23,00
● Safran	3,7	60 20 839	28 x 8	4	23,00
● Céladon	3,7	60 20 809	28 x 8	4	23,00
● Magenta	3,7	60 20 824	28 x 8	4	23,00



Sauteuse

Désignation	Litres	Code	Φ x Ht cm	SUR.	Prix HT
● Rose	2,7	60 20 928	24 x 9	2	41,60
● Crème	2,7	60 20 853	24 x 9	2	41,60
● Safran	2,7	60 20 838	24 x 9	2	41,60
● Céladon	2,7	60 20 808	24 x 9	2	41,60
● Magenta	2,7	60 20 823	24 x 9	2	41,60

## Colorama

**COUVERCLE**

En verre transparent avec bouton bakélite effet bois



Tous feux, dont induction

**REVÊTEMENT 3 COUCHES**

Revêtement anti-adhérent très résistant Skandia Xtreme PPG

**98%**  
**ALUMINIUM**  
**RECYCLÉ**



Cuisson saine sans PFOA

**ALUMINIUM FORGÉ**

épaisseur 2.5 mm

**Faitout Noisette****Faitout Crème****Faitout Safran****Faitout Céladon****Faitout Magenta**

Désignation	Litres	Code	Φ x Ht cm	SUR.	Prix HT
Rose	2,8	60 20 926	20 x 12,5	3	33,20
	5,5	60 20 927	24 x 16	3	49,90
Crème	2,8	60 20 851	20 x 12,5	3	33,20
	5,5	60 20 852	24 x 16	3	49,90
Safran	2,8	60 20 836	20 x 12,5	3	33,20
	5,5	60 20 837	24 x 16	3	49,90

Désignation	Litres	Code	Φ x Ht cm	SUR.	Prix HT
Céladon	2,8	60 20 806	20 x 12,5	3	33,20
	5,5	60 20 807	24 x 16	3	49,90
Magenta	2,8	60 20 821	20 x 12,5	3	33,20
	5,5	60 20 822	24 x 16	3	49,90
Olive	2,8	60 20 881	20 x 12,5	3	33,20
	5,5	60 20 882	24 x 16	3	49,90

**POIGNÉE ERGONOMIQUE**

Poignée bakélite soft touch avec revêtement effet bois

**INDUCTION**

Disque compatible tous feux dont induction

**Crêpière 26 cm / Galettière 32 cm**

Désignation	Litres	Code	Φ x Ht cm	SUR.	Prix HT
Rose Crêpe	0,7	60 20 930	26 x 2,5	4	24,90
Galette	0,6	60 20 931	32 x 1,5	4	25,90
Crème Crêpe	0,7	60 20 855	26 x 2,5	4	24,90
Galette	0,6	60 20 856	32 x 1,5	4	25,90
Safran Crêpe	0,7	60 20 840	26 x 2,5	4	24,90
Galette	0,6	60 20 841	32 x 1,5	4	25,90
Céladon Crêpe	0,7	60 20 810	26 x 2,5	4	24,90
Galette	0,6	60 20 811	32 x 1,5	4	25,90
Magenta Crêpe	0,7	60 20 825	26 x 2,5	4	24,90
Galette	0,6	60 20 826	32 x 1,5	4	25,90



## Cannelle

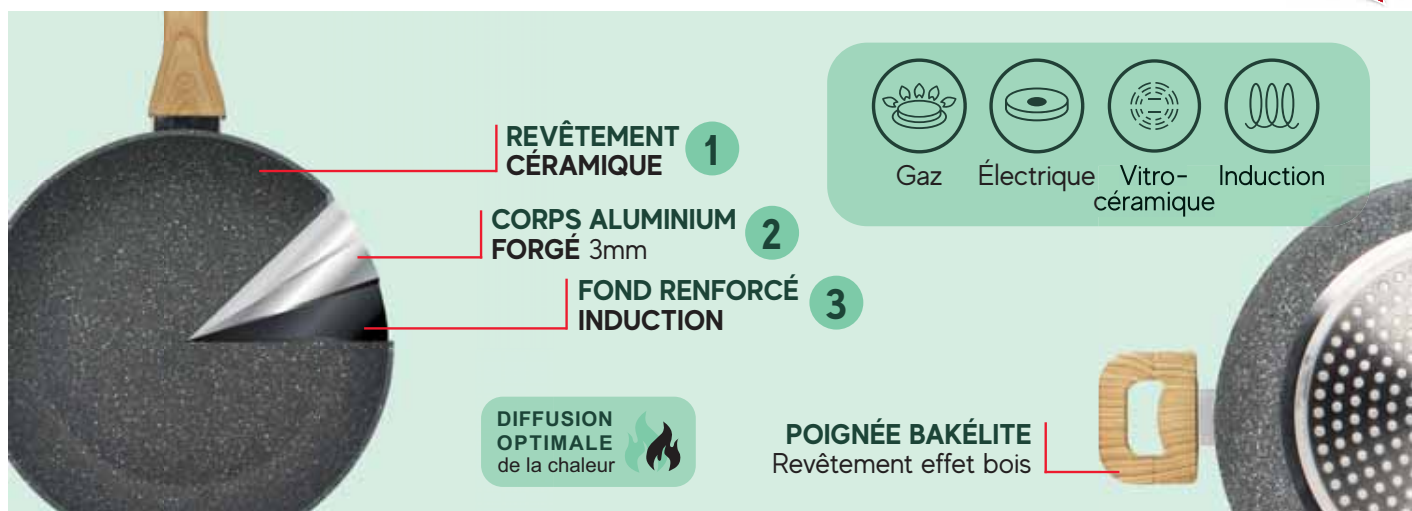

DIFFUSION OPTIMALE de la chaleur

POIGNÉE BAKÉLITE  
Revêtement effet bois

### NOUVEAU REVÊTEMENT CÉRAMIQUE

pour une cuisson saine



Wok

Désignation	Litres	Code	Φ x Ht cm	SUR.	Prix HT
Wok	3,5	60 20 038	28 x 8	3	19,55



Poêle

Désignation	Litres	Code	Φ x Ht cm	SUR.	Prix HT
Poêle	1,6	60 20 063	24 x 5,5	3	14,25
	2,3	60 20 064	28 x 6	3	17,55
	3	60 20 065	30 x 6	3	21,65



Sauteuse avec couvercle

Désignation	Litres	Code	Φ x Ht cm	SUR.	Prix HT
Sauteuse	2,2	60 20 039	24 x 10	2	22,45
	3,6	60 20 040	28 x 9	2	32,85

## Cerise

**1 NOUVEAU REVÊTEMENT  
CÉRAMIQUE**

Cuisson saine et sans accroche

**POIGNÉE BAKÉLITE**  
Effet métallisé rouge

**CORPS ALUMINIUM**  
Effet métallisé rouge  
2,5 mm

**FOND  
INDUCTION**

Gaz



Électrique

Vitro-  
céramique

Induction



Poêle

Désignation	Litres	Code	Φ x Ht cm	SUR.	Prix HT
Poêle	0,9	60 20 574	20 x 4	3	9,50
	1,4	60 20 575	24 x 4,5	3	12,50
	2,2	60 20 576	28 x 5	3	16,50
	3,5	60 20 577	32 x 6	3	21,50



Casserole

Désignation	Litres	Code	Φ x Ht cm	SUR.	Prix HT
Casserole	0,9	60 20 570	14 x 7	3	9,50
	1,3	60 20 571	16 x 8	3	10,50
	2,3	60 20 572	18 x 8,5	3	11,50
	2,5	60 20 573	20 x 9	3	13,50



Sauteuse avec couvercle

Désignation	Litres	Code	Φ x Ht cm	SUR.	Prix HT
Sauteuse	2,1	60 20 580	24,5 x 11	2	17,65



Wok

Désignation	Litres	Code	Φ x Ht cm	SUR.	Prix HT
Wok	3	60 20 581	28 x 8	3	17,65



Crêpière

Désignation	Code	Φ x Ht cm	SUR.	Prix HT
Crêpière	60 20 578	25 x 1,7	3	11,50



Faitout avec couvercle

Désignation	Litres	Code	Φ x Ht cm	SUR.	Prix HT
Faitout	4,2	60 20 579	24 x 17	4	23,50



## Poêles

Acier Inoxydable 18/10



**Triply**  
p.176  
Ø 20/24/28/32 cm



**Trinox**  
p.178  
Ø 24/28/30 cm



**Trinox Revêtu**  
p.179  
Ø 20/24/28/30 cm



**Inox Pro**  
p.280  
Ø 20/24/28/30 cm

Acier Inoxydable 18/10



**Easynox**  
p.182  
Ø 20/24/28 cm



**Iris Inox**  
p.184  
Ø 20/24/28 cm

Acier Inoxydable 18/0



**First Inox**  
p.185  
Ø 20/24/28 cm

Aluminium revêtement Céramique



**Alu Pro**  
p.186  
Ø 24/28/32/36/40 cm

Aluminium revêtement Céramique



**First Alu**  
p.187  
Ø 20/24/26/28/30 cm



**Colorama**  
p.188  
Ø 20/24/28 cm



**Cannelle**  
p.190  
Ø 20/24/28/30 cm



**Cerise**  
p.191  
Ø 20/24/28/32 cm

## Poêle à poisson

Acier Inoxydable 18/10



**Inox Pro**  
p.180  
37,5 cm

CUISSON

## Woks

Acier Inoxydable 18/10



**Triply**  
p.176  
Ø 24/28 cm



**Trinox revêtu**  
p.179  
Ø 28 cm



**Inox Pro**  
p.180  
Ø 30 cm



**Easynox**  
p.182  
Ø 28 cm



**Iris Inox**  
p.184  
Ø 28 cm

Acier Inoxydable 18/0



**First Inox**  
p.185  
Ø 28 cm



**Colorama**  
p.188  
Ø 28 cm



**Cannelle**  
p.190  
Ø 28 cm



**Cerise**  
p.191  
Ø 28 cm

## Crêpières

Aluminium revêtement Céramique



**Colorama**  
p.189  
Ø 26/32 cm



**Cerise**  
p.191  
Ø 25 cm

## Faitouts

Acier Inoxydable 18/10



**Triply**  
p.176  
Ø 24 cm



**Trinox**  
p.178  
Ø 20/24 cm



**Trinox Revêtu**  
p.179  
Ø 20/24 cm



**Inox Pro**  
p.180  
Ø 24 cm



**Easynox**  
p.182  
Ø 24 cm

Acier Inoxydable 18/0



**First Inox**  
p.185  
Ø 24 cm

Aluminium revêtement Céramique



**First alu**  
p.187  
Ø 20/24 cm



**Colorama**  
p.189  
Ø 20/24 cm



**Cerise**  
p.191  
Ø 24 cm

## Sauteuses

Acier Inoxydable 18/10



**Triply**  
p.176  
Ø 24 cm



**Trinox Revêtu**  
p.179  
Ø 24 cm



**Inox Pro**  
p.180  
Ø 28 cm



**First Inox**  
p.185  
Ø 24 cm

Acier Inoxydable 18/0

Aluminium revêtement Céramique



**Colorama**  
p.188  
Ø 24 cm



**Cannelle**  
p.190  
Ø 24/28 cm



**Cerise**  
p.191  
Ø 24 cm

## Casseroles

Acier Inoxydable 18/10



**Triply**  
p.176  
Ø 16/18/20 cm



**Trinox**  
p.178  
Ø 18/20 cm



**Trinox Revêtu**  
p.179  
Ø 14/16 cm



**Inox Pro**  
p.180  
Ø 14/16/18/20/24 cm

Acier Inoxydable 18/10



**Easynox**  
p.182  
Ø 16/18/20 cm



**Iris Inox**  
p.184  
Ø 16/18/20 cm

Acier Inoxydable 18/0



**First Inox**  
p.185  
Ø 14/16/18/20 cm

Aluminium revêtement Céramique



**First Alu**  
p.187  
Ø 16/18/20 cm

Aluminium revêtement Céramique



**Colorama**  
p.188  
Ø 16/18/20 cm



**Cerise**  
p.191  
Ø 14/16/18/20 cm

Fonte émaillée

## Colette & Volcano



Four



Gaz



Électrique



Vitro-céramique



Induction



**COCOTTE EN FONTE  
DIFFUSION UNIFORME  
DE LA CHALEUR**

**BOUTON  
ACIER INOXYDABLE**



**FONTE ÉMAILLÉE**  
Épaisseur 2.5 mm

**MAINTIENT L'HUMIDITÉ**  
Pour une cuisson savoureuse

**COUVERCLE AJUSTÉ**  
Pour retenir la vapeur

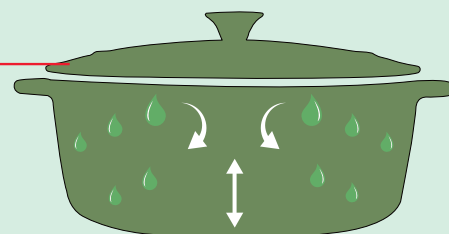

**INTÉRIEUR  
COUVERCLE**  
Avec picots pour  
un maintien de la  
vapeur d'eau



**Cocotte ovale avec couvercle**

Désignation	Code	Ccl	L x l x Ht cm	SUR.	Prix HT
Cocotte ovale rouge	60 20 101	400	27 x 21 x 11	2	41,55
	60 20 102	650	33 x 25 x 12,5	1	63,25
	60 20 103	900	36 x 27 x 14	1	78,85



**Cocotte ronde avec couvercle**

Désignation	Code	Ccl	Φ x Ht cm	SUR.	Prix HT
Cocotte ronde rouge	60 20 105	700	29 x 13	1	58,35



**Cocotte ovale avec couvercle**

Désignation	Code	Ccl	L x l x Ht cm	SUR.	Prix HT
Cocotte ovale verte	60 20 080	400	34,5 x 22 x 17	1	34,20



## Tajines &amp; Couscoussiers



Tajine 24 cm

Tajine 24 cm

Désignation	Litres	Code	Φ x Ht cm	SUR.	Prix HT
Céladon	1,6	60 20 041	24 x 21	4	27,00
Safran	1,6	60 20 047	24 x 21	4	27,00

Désignation	Litres	Code	Φ x Ht cm	SUR.	Prix HT
Magenta	1,6	60 20 042	24 x 21	4	27,00
Rose	1,6	60 20 046	24 x 21	4	27,00

**ALUMINIUM**  
Effet marbre

**PARTIE SUPÉRIEURE**

Passoire avec bas percé pour laisser passer la vapeur pour la cuisson du couscous



Four



Gaz



Électrique

Vitro-  
céramique

Induction



**COUVERCLE  
VERRE**

**ALUMINIUM FORGÉ**  
Épaisseur 2.5 mm

**POIGNÉES EN BAKÉLITE**  
Soudées

Couscoussier 24 cm

Désignation	Litres	Code	Φ x Ht cm	SUR.	Prix HT
Couscoussier	9	60 20 033	24 x 30,5	2	41,55

**COUVERCLE CÉRAMIQUE**  
Coloris jaune



**ALUMINIUM FORGÉ**  
Épaisseur 2.5 mm

Tajine 30 cm

Désignation	Litres	Code	Φ x Ht cm	SUR.	Prix HT
Tajine	2,5	60 20 032	30 x 23	2	41,55



**COUVERCLE  
VERRE**



**Couscoussier inox**

Code	Litres	Φ x Ht cm	SUR.	Prix HT
46 15 450	10	24 x 32	6	29,55



**Marmite inox**

Code	Litres	Φ x Ht cm	SUR.	Prix HT
46 15 455	9	24 x 20	2	27,95
46 15 451	17	30 x 40	2	41,95

**CORPS INOX**  
Durable, résistant à la rouille et à la corrosion  
Diffusion optimale de la chaleur

**POIGNÉE**  
Poignée rivetée en inox  
qui reste froide



**Bassine à confiture**

Code	Litres	Φ x Ht cm	SUR.	Prix HT
46 15 452	17	41 x 17	6	24,95



**Autocuiseur Authentique**

Désignation	Litres	Code	Φ x Ht cm	SUR.	Prix HT
Autocuiseur*	6	42 14 240	24 x 20	1	145,00



**Harry**



**Plat rectangle inox**

Désignation	Code	L	L x l x Ht cm	SUR.	Prix HT
Plat rectangle Inox	46 15 220	3	30 x 21 x 5	6	8,55
	46 15 221	4	35 x 25 x 6	6	11,25
	46 15 222	5	40 x 28 x 6	6	11,85

**Amandine**



**Plat à rôtir acier carbone**

Code	L x l x Ht cm	SUR.	Prix HT
60 20 003	43,5 x 29 x 6	6	10,25



**Couvercle inox**

Code	Φ cm	SUR.	Prix HT
46 15 210	21	6	2,65
46 15 211	25	6	3,32
46 15 212	30	6	4,17



**Couvercle silicone**

Code	L x l x Ht cm	SUR.	Prix HT
60 21 990	16/18/20	6	4,90
60 21 991	22/24/26	6	5,50
60 21 992	26/28/30	6	6,90

## Marmite à moules



Marmite à moules Noire

Marmite à moules Noire inscription "Moules"

Marmite à moules Rouge

Marmite à moules Blanche

Désignation	Code	Litres	Ø x Ht cm	SUR.	Prix HT
Marmite Noire	36 45 567	2,7	18 x 15,5	6	8,95
Marmite 'Moules'	36 45 563	2,7	18 x 15,5	6	9,95
	36 45 564	5	24 x 17,5	6	14,55

Désignation	Code	Litres	Ø x Ht cm	SUR.	Prix HT
Marmite Rouge	36 45 562	2,7	18 x 15,5	6	11,10
Marmite Blanche	36 45 561	2,7	18 x 15,5	2	11,95





**ACIER ÉMAILLÉ**  
Épaisseur 0,6 mm

**DIFFUSION OPTIMALE** de la chaleur 

  
Gaz

  
Électrique

  
Vitro-céramique

  
Induction



Marmite à moules en Acier Inoxydable

Code	Litres	Ø x Ht cm	SUR.	Prix HT
60 20 360	2,7	18 x 19,5	4	11,40

## Friteuse



Panier friteuse



Friteuse du nord émail avec panier



Poêle à frire émail avec panier



Friteuse émail noire avec panier et couvercle

Désignation	Litres	Code	L x l x Ht cm	SUR.	Prix HT
Panier friteuse		36 45 025	24 x 9,5	12	3,95
Poêle à frire	2,7	36 45 749	44 x 26 x 10,5	6	9,95

Désignation	Litres	Code	Ø x Ht cm	SUR.	Prix HT
Friteuse du nord	6,8	36 45 575	28 x 20	6	18,69
Friteuse avec couvercle	2,6	36 45 579	20 x 11,5	6	9,55
	5	36 45 580	26 x 11,5	6	18,71



# Octave



**DESIGN ÉLÉGANT**  
Look tendance, intérieur brillant, extérieur mat

**PLAT EN GRÈS**  
Résistant aux chocs thermiques et aux rayures

**CUISSON LENTE**  
Rétention thermique exceptionnelle

**3 COLORIS TENDANCES**  
Terracotta, Crème et Kaki



Compatible congélateur, micro-ondes, lave-vaisselle & four



Plat rectangulaire (x4 tailles)

Désignation	Litres	Code	L x l x Ht cm	SUR.	Prix HT
● Beige	0,5	33 56 125	22 x 13,5 x 4,5	6	5,75
	1,1	33 56 130	27 x 16,5 x 5,8	6	9,95
	2,2	33 56 135	33 x 20 x 6,5	6	14,55
● Terracotta	3,3	33 56 140	38 x 23 x 8	6	21,95
	0,5	33 56 126	22 x 13,5 x 4,5	6	5,75
	1,1	33 56 131	27 x 16,5 x 5,8	6	9,95
● Kaki	2,2	33 56 136	33 x 20 x 6,5	6	14,55
	3,3	33 56 141	38 x 23 x 8	6	21,95
	0,5	33 56 127	22 x 13,5 x 4,5	6	5,75
● Kaki	1,1	33 56 132	27 x 16,5 x 5,8	6	9,95
	2,2	33 56 137	33 x 20 x 6,5	6	14,55
	3,3	33 56 142	38 x 23 x 8	6	21,95



Plat ovale



Plat carré



Plat rond



Ramequin 12 cm



Ramequin 9 cm

Désignation	Code	Ccl	L x l x Ht cm	SUR.	Prix HT
Plat ovale	● 33 56 161	95	27 x 17 x 5,5	6	9,35
	● 33 56 162	95	27 x 17 x 5,5	6	9,35
Plat carré	● 33 56 165	120	24 x 19 x 5,8	6	9,95
	● 33 56 166	120	24 x 19 x 5,8	6	9,95
	● 33 56 167	120	24 x 19 x 5,8	6	9,95

Désignation	Code	Ccl	Φ x Ht cm	SUR.	Prix HT
Plat rond	● 33 56 170	95	20 x 5,8	6	8,95
	● 33 56 170	95	20 x 5,8	6	8,95
	● 33 56 170	95	20 x 5,8	6	8,95
Ramequin 12 cm	● 33 56 150	40	12 x 6	6	3,65
	● 33 56 151	40	12 x 6	6	3,65
Ramequin 9 cm	● 33 56 152	40	12 x 6	6	3,65
	● 33 56 145	18	9 x 5	12	1,85
	● 33 56 146	18	9 x 5	12	1,85
	● 33 56 147	18	9 x 5	12	1,85



Plat grille



Tourtière



Moule à cake

Code	Ccl	L x l x Ht cm	SUR.	Prix HT
● 33 56 155	84	26,5 x 15 x 4,5	6	8,95
● 33 56 156	84	26,5 x 15 x 4,5	6	8,95
● 33 56 157	84	26,5 x 15 x 4,5	6	8,95

Code	Ccl	Φ x Ht cm	SUR.	Prix HT
● 33 56 180	180	29 x 4,5	6	11,45
● 33 56 181	180	29 x 4,5	6	11,45
● 33 56 182	180	29 x 4,5	6	11,45

Code	Ccl	L x l x Ht cm	SUR.	Prix HT
● 33 56 185	180	27 x 13,5 x 8	6	7,25
● 33 56 186	180	27 x 13,5 x 8	6	7,25
● 33 56 187	180	27 x 13,5 x 8	6	7,25

## Amandine Colorama



**REVÊTEMENT CÉRAMIQUE CÉLADON**  
Cuisson sans accroche et nettoyage facile

**ACIER CARBONE**  
Épaisseur 0,6mm

  Compatible four & lave-vaisselle

3 TAILLES DISPONIBLES

35x27 cm

40x28 cm

45x30 cm



Plat à rotir Céladon

Désignation	Code	L x l x Ht cm	SUR.	Prix HT
Plat Céladon	60 21 073	35 x 27 x 6,8	6	4,95
	60 21 074	40 x 28 x 7	6	5,50
	60 21 075	45 x 30 x 7,5	6	5,95



Moule à manqué Noisette

Code	Ø x Ht cm	SUR.	Prix HT
60 20 787	26 x 5	6	4,35



Moule à tarte Céladon

Code	Ø x Ht cm	SUR.	Prix HT
60 20 788	28 x 3	6	4,25



Moule à tarte Noisette

Code	Ø x Ht cm	SUR.	Prix HT
60 20 789	30 x 3	6	4,70



Moule à charnière Magenta

Code	Ø x Ht cm	SUR.	Prix HT
60 20 784	22 x 7	6	5,50



Moule à charnière Safran

Code	Ø x Ht cm	SUR.	Prix HT
60 20 785	24 x 6,8	6	5,60



Moule à charnière Olive

Code	Ø x Ht cm	SUR.	Prix HT
60 20 786	26 x 7	6	6,05



Moule à cake Crème

Code	L x l x Ht cm	SUR.	Prix HT
60 20 783	31 x 11,5 x 7,5	6	4,65

## Angélique

Acier Inoxydable

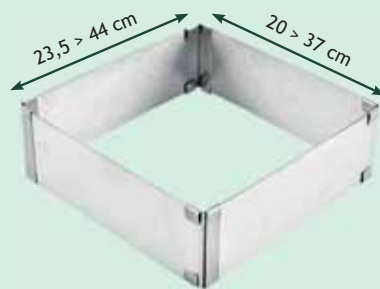

Cadre extensible rectangulaire

Code	L x l x Ht cm	SUR.	Prix HT
60 20 023	23,5>44 x 20>37 x 5	12	8,29



Cadre extensible rond

Code	Ø x Ht cm	SUR.	Prix HT
60 20 024	16>30 x 17	12	8,29

## Amandine

La gamme Amandine, ce sont des moules solides et durables avec un **revêtement anti-adhésif une couche Goldenflon**



**ACIER CARBONE**  
Épaisseur 0,4mm  
Pour une cuisson homogène



Compatible congélateur, four & lave-vaisselle

CUISSON



**SYSTÈME DE CHARNIÈRE**  
Pour un démoulage facile et rapide en un clic

Moule à charnière rond

Désignation	Code	L x l x Ht cm	SUR.	Prix HT
Moule à charnière rond	60 20 757	14 x 6,8	6	3,85
	60 20 758	18 x 6,2	6	4,55
	60 20 752	24 x 6,8	6	4,55



Moule à charnière carré

Désignation	Code	L x l x Ht cm	SUR.	Prix HT
Moule à charnière carré	60 20 704	26 x 26 x 6,5	6	5,95



Plaque au four



Plaque à pizza

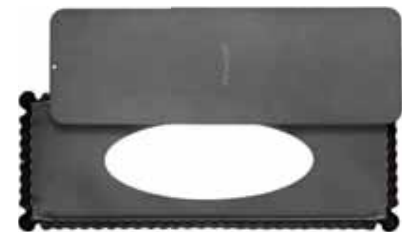

Moule à tarte rectangle



Moule à cake

Désignation	Code	L x l x Ht cm	SUR.	Prix HT
Plaque au four	60 20 745	38 x 27 x 2	6	3,95
Plaque à pizza	60 20 761	33 x 33 x 1,5	6	4,50

Désignation	Code	L x l x Ht cm	SUR.	Prix HT
Moule rectangle	60 20 749	35,5 x 13 x 2,5	6	5,25
Moule à cake	60 20 755	30,5 x 11,5 x 8	6	3,55

## Amandine



Moule à manqué carré



Moule à manqué rond



Moule à tarte rond



Moule à tarte rond perforé

Désignation	Code	Φ x Ht cm	SUR.	Prix HT
Moule carré	60 20 756	21 x 4,5	6	3,05
Moule rond	60 20 751	26 x 5	6	3,55

Désignation	Code	Φ x Ht cm	SUR.	Prix HT
Moule tarte	60 20 754	32 x 3	6	4,25
Moule tarte perforé	60 20 753	28 x 3	6	3,85
Moule tarte perforé	60 20 748	32 x 3	6	4,55



Moule à 12 muffins



Moule à 6 muffins



Panier cuisson



Moule cuisson

Désignation	Code	L x l x Ht cm	SUR.	Prix HT
Moule à 12 muffins	60 20 747	35 x 26,5 x 3	6	6,55
Moule à 6 muffins	60 20 746	26,5 x 18 x 3	6	3,95

Désignation	Code	Ø x Ht cm	SUR.	Prix HT
Panier cuisson	60 20 672	20 x 7	6	3,60
Moule cuisson	60 20 671	20 x 2,5	2,5	1,95

## Accessoires Silicone

## MOULE SILICONE

Flexible, anti-adhésif et résistant à la chaleur



Plaque génoise

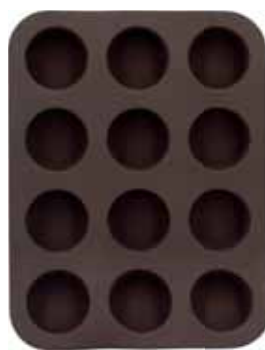

Moule à 12 muffins



Moule à 6 financiers

Code	L x l x Ht cm	SUR.	Prix HT
60 20 030	36 x 26,5 x 1	12	6,85

Code	L x l x Ht cm	SUR.	Prix HT
60 20 773	25 x 19 x 2,5	12	10,79

Code	L x l x Ht cm	SUR.	Prix HT
60 20 774	26,5 x 16 x 2,5	12	9,96

## Bacs gastronormes en inox

EMPLIABLE



**ACIER INOXYDABLE 18/10**

Robuste et facile à nettoyer

### UNE GRANDE RÉSISTANCE

Résiste aux chocs thermiques (changement de températures rapides) et aux températures extrêmes (jusqu'à 400°)



Compatible congélateur, lave vaisselle et four.

### USAGE PROFESSIONNEL

Bacs adaptés pour la restauration et l'hôtellerie. Ils s'adaptent aux équipements normés : armoires réfrigérées, chariots de transport, présentoirs, fours, éviers, ...



A. Bac 1/1 : 53 x 32,5 cm

Désignation	Code	Litres	Profondeur cm	SUR.	Prix HT
A. Bac 1/1	46 10 450	5,5	prof 4	6	14,71
	46 10 451	7,2	prof 5,5	6	16,46
	46 10 452	8,5	prof 6,5	6	16,41
	46 10 453	13,3	prof 10	6	22,11
	46 10 454	20,6	prof 15	6	30,21
	46 10 455	30	prof 20	6	34,70
	46 10 489	8,5	prof 6,5 perforé	6	18,86
	46 10 490	13,3	prof 10 perforé	6	24,07



B. Bac 1/2 : 26,5 x 32,5 cm

Désignation	Code	Litres	Profondeur cm	SUR.	Prix HT
B. Bac 1/2	46 10 457	3,2	prof 5,5	12	9,44
	46 10 458	4,2	prof 6,5	12	10,01
	46 10 459	8	prof 10	6	14,04



C. Bac 1/9 : 17,6 x 10,8 cm

Code	Litres	Profondeur cm	SUR.	Prix HT
46 10 476	0,7	prof 6,5	48	4,00
46 10 477	0,85	prof 10	48	6,53



D. Bac 1/3 : 17,6 x 32,5 cm

Code	Litres	Profondeur cm	SUR.	Prix HT
46 10 464	2,5	prof 6,5	18	8,02
46 10 465	3,8	prof 10	18	11,30
46 10 466	5,9	prof 15	18	15,48
46 10 467	8,1	prof 20	6	17,70



E. Bac 1/4 : 26,5 x 16,2 cm

Code	Litres	Profondeur cm	SUR.	Prix HT
46 10 468	1,9	prof 6,5	6	6,99
46 10 470	4,1	prof 15	1	13,88



F. Bac 1/6 : 17,6 x 16,2 cm

Code	Litres	Profondeur cm	SUR.	Prix HT
46 10 473	1,6	prof 10	36	7,95
46 10 474	2,5	prof 15	36	9,98



G. Couverture avec poignée

Code	Bac adapté	L x l cm	SUR.	Prix HT
46 10 483	1/9	17,6 x 10,8	48	2,25
46 10 482	1/6	17,6 x 16,2	36	2,85
46 10 481	1/4	26,5 x 16,2	24	5,20
46 10 480	1/3	32,5 x 17,6	18	5,50
46 10 479	1/2	32,5 x 26,5	12	7,15
46 10 478	1/1	53 x 32,5	6	14,45



H. Pince inox bac

Code	L x l x Ht cm	SUR.	Prix HT
46 10 492	22 x 60 x 45	12	18,55

## Bacs en polypropylène

### HAUTE RÉSISTANCE

Plats conçus en polypropylène supportant des températures de -40°C à 70°C.

### TRANSPARENCE

Identification du contenu très rapidement grâce à la transparence.



Compatible congélateur,  
lave vaisselle.



H. Bac 1/1 : 53 x 32,5 cm

Désignation	Code	Litres	Profondeur cm	SUR.	Prix HT
H. Bac 1/1	46 10 550	8,5	prof 6,5	6	11,85
	46 10 551	12,9	prof 10	6	14,05
	46 10 552	19,5	prof 15	6	17,75
	46 10 553	25,9	prof 20	6	22,45



I. Bac 1/2 : 26,5 x 32,5 cm

Désignation	Code	Litres	Profondeur cm	SUR.	Prix HT
I. Bac 1/2	46 10 554	3,9	prof 6,5	12	6,10
	46 10 555	5,9	prof 10	12	8,65
	46 10 556	8,8	prof 15	12	10,20



J. Bac 1/3 : 17,6 x 32,5 cm

Désignation	Code	Litres	Profondeur cm	SUR.	Prix HT
J. Bac 1/3	46 10 558	2,4	prof 6,5	18	4,90
	46 10 559	3,8	prof 10	18	5,85
	46 10 561	5,1	prof 15	18	7,25
	46 10 562	6,9	prof 20	18	8,85



K. Bac 1/4 : 26,5 x 16,2 cm

Désignation	Code	Litres	Profondeur cm	SUR.	Prix HT
K. Bac 1/4	46 10 564	2,4	prof 10	24	5,55
	46 10 565	3,7	prof 15	24	5,95



L. Bac 1/6 : 17,6 x 16,2 cm

Code	Litres	Profondeur cm	SUR.	Prix HT
46 10 566	1	prof 6,5	36	3,75
46 10 567	1,6	prof 10	36	4,05
46 10 568	2,2	prof 15	36	5,65



M. Bac 1/9 : 17,6 x 10,8 cm

Code	Litres	Profondeur cm	SUR.	Prix HT
46 10 569	0,9	prof 10	48	3,75



N. Couverture

Code	Bac adapté	L x l cm	SUR.	Prix HT
46 10 575	1/9	17,6 x 10,8	48	1,95
46 10 574	1/6	17,6 x 16,2	36	2,15
46 10 573	1/4	26,5 x 16,2	24	3,30
46 10 572	1/3	32,5 x 17,6	18	3,95
46 10 571	1/2	32,5 x 26,5	12	5,35
46 10 570	1/1	53 x 32,5	6	8,95

# Ô Cuisine



**Plat ovale classique**



**Plat gratin**



**Plat rectangle**

Désignation	Ccl	Code	L x l x Ht cm	SUR.	Prix HT
Plat ovale	200	75 41 456	30 x 21 x 6,2	4	6,30
	300	75 41 457	35 x 24 x 6,5	6	7,73
	400	75 41 458	39 x 27 x 6,5	4	9,25
Plat gratin	50	75 41 460	19 x 14 x 4	6	3,75
	80	75 41 462	25 x 20 x 5,5	6	4,97

Désignation	Ccl	Code	L x l x Ht cm	SUR.	Prix HT
Plat rectangle	150	14 59 003	32 x 20 x 5	6	5,75
	200	14 59 004	35 x 23 x 5,5	6	7,15
	250	14 59 005	39 x 23 x 5,5	6	8,50



**Plat carré**

Code	Ccl	L x l x Ht cm	SUR.	Prix HT
14 59 009	100	20 x 17 x 6	10	5,68

### PLAT EN VERRE

Verre borosilicate, haute résistance à la chaleur, convient à un usage au four, au micro-ondes, au réfrigérateur et au congélateur



**Jatte**

Code	Litres	Φ x Ht cm	SUR.	Prix HT
14 59 039	3	24 x 13	6	7,67



**Jate expert bowl**

Code	Litres	L x l x Ht cm	SUR.	Prix HT
14 59 040	4,2	29 x 27 x 15	3	13,54



**Moule à cake**

Code	Ccl	L x l x Ht cm	SUR.	Prix HT
75 41 473	150	28 x 26 x 12	6	7,21



**Moule à tarte**

Code	Ccl	Φ x Ht cm	SUR.	Prix HT
75 41 472	250	27 x 3,5	8	6,00



## Accessoires Airfryer



Plat rond



Plat rectangle



Plat carré

Désignation	Code	Ccl	L x l x Ht cm	SUR.	Prix HT
Plat rond	14 50 140	100	20 x 18 x 7	4	9,55
	14 50 144	230	26 x 23 x 8	5	10,75
Plat rectangle	14 50 143	120	23 x 15 x 7	8	10,75
Plat carré	14 50 141	100	20 x 17 x 6	10	9,55
	14 50 142	220	25 x 22 x 7	8	10,75



## Slow Cook



Cocotte ovale classic

Désignation	Ccl	Code	L x l x Ht cm	SUR.	Prix HT
Cocotte ovale	440	14 50 076	38 x 23 x 15	3	28,81

## Slow Cook



Cocotte rectangle

Désignation	Ccl	Code	L x l x Ht cm	SUR.	Prix HT
Cocotte rectangle	670	14 50 040	37 x 22 x 14	3	30,80

## 4 en 1



Cocotte ronde

Désignation	Ccl	Code	L x l x Ht cm	SUR.	Prix HT
Cocotte ronde	140	14 50 098	21 x 18 x 8,5	3	14,33
	210	14 50 096	24 x 20 x 10	3	12,46
	300	14 50 094	27 x 23 x 11	3	10,56
	350	14 50 074	32 x 27 x 14	3	22,53

## Ô Cuisine



Cocotte ovale

Désignation	Ccl	Code	L x l x Ht cm	SUR.	Prix HT
Cocotte ovale	400	14 59 018	34 x 22 x 13,5	3	14,00



Cocotte ronde

Désignation	Ccl	Code	L x l x Ht cm	SUR.	Prix HT
Cocotte ronde	100	75 41 469	21 x 17,8 x 8,3	3	7,59
	160	75 41 465	23,9 x 20,2 x 9,8	3	8,79
	250	75 41 466	23 x 28 x 13	3	9,46

 New products  
Nouveautés



**UNE GRANDE RÉSISTANCE**

Résiste aux chocs thermiques (changement de températures rapides) et aux températures extrêmes (jusqu'à 400°)



**Cook & freeze**



**Plat rectangle**



**Plat rond**

Désignation	Code	Ccl	L x l x Ht cm	SUR.	Prix HT
Plat rectangle	14 51 004	80	19 x 14 x 4	6	9,33
	14 51 005	150	22 x 17 x 6	6	12,48
	14 51 006	260	25 x 19 x 8	6	15,60
	14 51 007	400	27 x 22 x 9	3	17,47

Désignation	Code	Ccl	L x l x Ht cm	SUR.	Prix HT
Plat rond	14 51 057	60	12 x 6	8	?
	14 51 058	110	15 x 9	4	?

**COUVERCLE**

Couvercle à valves breveté



Compatible congélateur, micro-ondes, lave vaisselle et four (sauf couvercle)

**Cook & heat**



**Plat rectangle**



**Plat carré**



**Plat rond**

Désignation	Code	Ccl	L x l x Ht cm	SUR.	Prix HT
Plat rectangle	14 51 023	40	17 x 10 x 5	5	9,10
	14 51 024	110	23 x 15 x 6	5	12,18
	14 51 025	250	28 x 20 x 8	4	16,11

Désignation	Code	Ccl	L x l x Ht cm	SUR.	Prix HT
Plat carré	14 51 022	220	25 x 22 x 7	4	16,11
Plat rond	14 51 018	110	20 x 18 x 7	5	12,18

**Let's Share**



**Plat carré**



**Plat ovale**

Désignation	Code	Ccl	L x l x Ht cm	SUR.	Prix HT
Plat carré	14 50 010	230	29 x 23 x 7	6	15,82

Désignation	Code	Ccl	L x l x Ht cm	SUR.	Prix HT
Plat ovale	14 50 015	200	30 x 21 x 7	4	13,30
	14 50 016	280	35 x 24 x 6	6	17,10
	14 50 017	450	39 x 27 x 7	4	20,92



**Plat rectangle**

Désignation	Code	Ccl	L x l x Ht cm	SUR.	Prix HT
Plat rectangle	14 50 011	140	27 x 17 x 6	6	12,00
	14 50 012	210	31 x 20 x 6	6	15,19
	14 50 013	290	35 x 23 x 6	6	18,42
	14 50 014	380	39 x 25 x 7	6	21,54





Pyrex



LE VERRE PYREX® EST UNIQUE

En borosilicate de qualité supérieure, d'une extrême résistance aux chocs thermiques et mécaniques. Tous les produits de la gamme en verre Pyrex® sont garantis 10 ans



Essentials



Plat ovale

Code	Ccl	L x l x Ht cm	SUR.	Prix HT
14 50 035	65	21 x 13 x 5	10	7,46
14 50 036	160	26 x 18 x 6	6	9,99



Plat lasagne Cook & Enjoy

Code	Ccl	L x l x Ht cm	SUR.	Prix HT
14 50 032	260	35 x 23 x 5	6	13,75
14 50 033	370	40 x 28 x 6	6	18,77



Panier vapeur

Code	Ccl	Φ x Ht cm	SUR.	Prix HT
14 50 082	400	24 x 7	6	15,19

Cook & Enjoy



Moule à manqué

Code	Ccl	Φ x Ht cm	SUR.	Prix HT
14 50 155	210	26 x 6	6	11,54

Iconics



Jatte

Code	Ccl	Φ x Ht cm	SUR.	Prix HT
14 50 116	50	14 x 8	12	3,76
14 50 117	100	17 x 10	12	5,30
14 50 118	200	21 x 11	6	7,35
14 50 119	300	24 x 13	6	9,37

Cook & Enjoy



Moule à soufflé

Code	Ccl	Φ x Ht cm	SUR.	Prix HT
14 50 158	250	21 x 9,9	4	11,54



Cook & Enjoy



Moule à cake

Code	Ccl	L x l x Ht cm	SUR.	Prix HT
14 50 156	150	28 x 11 x 8	4	9,73
14 50 157	170	31 x 12 x 8	4	11,54

Iconics



Moule à tarte

Code	Ccl	Φ x Ht cm	SUR.	Prix HT
14 50 151	110	25 x 3,49	6	9,73
14 50 152	140	28 x 3,65	6	11,54
14 50 153	180	31 x 3,5	6	13,40

**Cristal**



**Lot 2 plats carrés**

Désignation	Code	L x l x Ht cm	SUR.	Prix HT
Lot 2 plats carrés	16 92 037	22 x 22 x 5 28 x 28 x 6	4	10,95



**Lot 2 plats ovales**

Désignation	Code	L x l x Ht cm	SUR.	Prix HT
Lot 2 plats ovales	16 92 036	26 x 18 x 6 35 x 25 x 5	4	10,95



**Lot 2 plats à tartes**

Désignation	Code	Ø x Ht cm	SUR.	Prix HT
Lot 2 plats à tartes	16 92 038	26 x 4 32 x 5	4	10,95



**Cocotte**

Désignation	Ccl	Code	L x l x Ht cm	SUR.	Prix HT
Cocotte	510	16 90 025	35,5 x 20 x 15	4	10,85



**PLAT EN VERRE**

Verre borosilicate, convient à un usage au four, au micro-ondes, au réfrigérateur et au congélateur



## So Urban

Parfaitement empilables, et ultra fonctionnelles pour l'optimisation du rangement et des présentations. Verre trempé : Haute résistance thermique et mécanique. Passe au micro-ondes. Fond et couvercle conçus pour lavages en lave-vaisselle industriel. Couvercle en polyéthylène.

### Collection 2025

Désignation	Ccl	Code	Φ x Ht cm	SUR.	Prix HT
Coupelle seule S	37	75 16 219	11 x 7,3	24	1,51
Couvercle S		75 16 235	11 x 1,2	24	0,94
Coupelle + couvercle S	37	75 16 218	11 x 7,5	24	2,88
Coupelle seule M	80	75 16 233	14 x 8,8	24	2,58
Couvercle M		75 16 236	14,5 x 1,2	24	1,09
Coupelle + couvercle M	80	75 16 231	14,5 x 9	24	4,24
Coupelle seule L	110	75 16 256	17 x 7,1	12	4,05
Couvercle L		75 16 243	17,5 x 1,2	12	1,59
Coupelle + couvercle L	110	75 16 257	17,5 x 7,5	12	6,67



## Food box

Boîte en verre trempé transparent extra résistant. Hermétique, pas de dégradation du goût, ni de l'odeur des aliments. Facile à stocker, les boîtes s'empilent à condition de laisser le couvercle. Couvercle translucide neutre.



Boîte hermétique rectangulaire

Désignation	Ccl	Code	L x l x Ht cm	SUR.	Prix HT
Boîte Food box	82	75 53 011	17,5 x 13 x 6	12	3,31
Couvercle		75 53 026	18,6 x 13,7	12	1,12
Boîte Food box	122	75 53 012	21 x 15,5 x 6,5	12	4,00
Couvercle		75 53 027	21,4 x 15,8	12	1,32

## Cassis



Lot de 6 bols avec couvercle coloré

Désignation	Code	Φ cm	SUR.	Prix HT
Lot 6 bols	50 39 040	23 - 20 - 17 - 14 - 13 (x2)	2	14,95



Lot de 5 bols avec couvercle gris

Désignation	Code	Φ cm	SUR.	Prix HT
Lot 5 bols	50 39 038	17,3 - 14,2 - 12,8 - 10,9 - 9,4	6	5,95



Lot de 4 saladiers avec couvercle coloré

Désignation	Code	Φ cm	SUR.	Prix HT
Lot 4 saladiers	16 11 889	23 - 20 - 17 - 14	2	14,84



**VERRE BOROSILICATE**  
Sécurité alimentaire



Compatible congélateur, micro-ondes, lave vaisselle et four (sauf couvercle)

**CONSERVATION**  
Par pression de l'air ⇄

**OUVERTURE FACILE**  
Avec la languette

**APPUYER POUR CONSERVER**





**Boîte ronde Lilas**

Désignation	Code	Ccl	Ø x Ht cm	SUR.	Prix HT
Boîte ronde Lilas	50 39 080	25	9,7 x 5,4	6	4,70
Lilas	50 39 082	47	12,3 x 6,3	6	5,50



**Boîte ronde Vert d'eau**

Désignation	Code	Ccl	Ø x Ht cm	SUR.	Prix HT
Boîte ronde Vert d'eau	50 39 081	25	9,7 x 5,4	6	4,70
Vert d'eau	50 39 083	47	12,3 x 6,3	6	5,50



**Boîte rectangle Lilas**

Désignation	Code	Ccl	L x l x Ht cm	SUR.	Prix HT
Boîte rectangle Lilas	50 39 084	82	19,5 x 13,9 x 4,5	6	7,90
Lilas	50 39 086	150	21,9 x 17 x 6	6	9,90
	50 39 088	260	24,6 x 20 x 7,6	6	12,50



**Boîte rectangle Vert d'eau**

Désignation	Code	Ccl	L x l x Ht cm	SUR.	Prix HT
Boîte rectangle Vert d'eau	50 39 085	82	19,5 x 13,9 x 4,5	6	7,90
Vert d'eau	50 39 087	150	21,9 x 17 x 6	6	9,90
	50 39 089	260	24,6 x 20 x 7,6	6	12,50

## Clémentine



Boîte carrée + couvercle

Désignation	Code	Ccl	L x l x Ht cm	SUR.	Prix HT
Boîte carrée	50 40 485	31	11,7 x 11,7 x 5,7	6	2,95
	50 40 486	50	15,5 x 15,5 x 6,8	6	3,55
	50 40 487	80	17,8 x 17,8 x 7,5	6	4,55



Boîte rectangulaire + couvercle

Désignation	Code	Ccl	L x l x Ht cm	SUR.	Prix HT
Boîte rectangulaire	50 40 488	37	15,3 x 11,2 x 5,7	6	2,95
	50 40 489	63	18 x 13,5 x 6,1	6	4,25
	50 40 490	104	20,5 x 15,5 x 7	6	4,95
	50 40 494	150	23 x 17,5 x 7,6	6	7,95
	50 40 503	226	24,5 x 19,5 x 7,7	6	8,25



Boîte ronde + couvercle

Désignation	Code	Ccl	Φ x Ht cm	SUR.	Prix HT
Boîte ronde	50 40 491	37	13,5 x 6,2	6	2,95
	50 40 492	64	15,5 x 6,8	6	3,95
	50 40 493	93	17,8 x 7,5	6	4,55



Compatible congélateur, micro-ondes, lave vaisselle et four (sauf couvercle)

**VALVE VAPEUR**

Pour réchauffer au micro-ondes

**100% HERMÉTIQUE**

Excellente conservation grâce au couvercle à clap muni d'un joint en silicone

**VERRE BOROSILICATE**

Résistant aux rayures ainsi qu'aux chocs. Il peut passer directement du congélateur au four. C'est un matériau sain sans BPA.

# TERRINES

Collection by LE PARFAIT



Un acteur incontournable pour tous les professionnels de la restauration

*Le Parfait*



## Stérilisateur

Le nouveau stérilisateur électrique et automatique Le Parfait® facilite la conservation des aliments avec une cuve en inox, des poignées thermo-isolantes, un couvercle en plastique noir, un robinet de vidange et un écran LCD avec minuterie automatique pour une stérilisation simple et efficace.



Stérilisateur 23 L



Stérilisateur 45 L

Code	Code	L	ø. x Ht. cm	SUR.	Prix HT
Stérilisateur	15 10 325	23	39 x 46	1	175,00
	15 10 326	45	38 x 61,5	1	210,00

## Bocal Bistrot

Le bocal "Bistrot", est disponible en deux tailles et dispose d'un système de fermeture hermétique à clips en acier inoxydable. Étanche, il permet de conserver et transporter les aliments en toute sécurité. Sans ses clips amovibles, le bocal est adapté au micro-ondes, ainsi qu'à la pasteurisation et stérilisation pour une conservation longue durée. Les clips sont fixés à l'armature, évitant tout risque de perte.



### MONTURE INOX

3 Clips amovibles en acier inoxydable



Lot 6 bocaux 25,5 cl

Lot 6 bocaux 42,5 cl

Lot 6 bocaux 58 cl

Désignation	Code	Ccl	Ø x Ht cm	SUR.	Prix HT Lot de 6
Lot de 6 Bocaux bistrot	15 10 318	25,5	8,5 x 7,5	1	21,95
	15 10 319	42,5	9,5 x 9	1	28,65
	15 10 324	58	9,5 x 12,5	1	31,25

## Le Parfait "Color Vis"

Le meilleur bocal pour le vac. Ces bocaux excellent dans la conservation de recettes qui ne nécessitent pas de traitement thermique (stérilisation ou pasteurisation). Des couvercles colorés pour dissocier vos préparations et vos plats à emporter.

Utilisation possible de capsules et couvercles Familia Wiss ø 100 sur la gamme À VIS.

Couvercles étanches grâce à leur nouveau joint Alvéolit qui prend la forme d'un disque plein blanc qui se maintient parfaitement dans le fond des couvercles.



Bocaux 1L

Bocaux 2L

Bocaux 3L

Désignation	L	Code	Ø x Ht cm	SUR.	Prix HT
Bocal Orange	1	15 10 315	10,8 x 17	6	3,15
	2	15 10 316	12,2 x 24,5	6	3,95
	3	15 10 317	13,8 x 27,5	3	6,75
Bocal Rouge	1	15 10 365	10,8 x 17	6	3,75
Bocal Bleu	2	15 10 361	12,2 x 24,5	6	5,15
Bocal Vert foncé	2	15 10 376	12,2 x 24,5	6	5,20
Bocal Vert clair	1	15 10 370	10,8 x 17	6	3,75
	3	15 10 372	13,8 x 27,5	3	6,75

Autres couleurs nous consulter

 New products Nouveautés



## Terrines «Le Parfait Familia Wiss»

Les Familia Wiss sont une alternative de choix pour la vente à emporter car une fois ouvertes elles passent au micro-ondes. Elles accueillent toutes les préparations (à l'exception des vinaigres et saumures qui favorisent la corrosion des capsules). La forme droite permet de démouler facilement.



Pack de 6 terrines

Désignation	Code	g	Ø x Ht cm	SUR.	Prix HT
6 terrines	15 10 145	200	8,75 x 6,25	1	13,95
couvercles + capsules	15 10 146	350	10,35 x 7,33	1	16,95
	15 10 147	500	10,35 x 9,38	1	17,95
	15 10 148	750	10,35 x 14,28	1	19,85
	15 10 149	1000	10,35 x 14,28	1	21,35
	15 10 150	1000	11,6 x 14,28	1	26,35
	15 10 151	1500	11,6 x 21,25	1	28,95



Bocaux vendus au pack avec rondelles fournies

Code	Pack	Ccl	ø. x Ht. cm	SUR.	Prix HT
15 10 006	6 bocaux	50	10,8 x 10,85	1	18,55
15 10 007	6 bocaux	75	10,8 x 14,5	1	20,20
15 10 008	6 bocaux	100	10,8 x 17,5	1	19,15
15 10 009	6 bocaux	150	10,8 x 25,5	1	25,65
15 10 010	6 bocaux	200	12 x 25	1	29,85
15 10 011	3 bocaux	300	13,8 x 28,34	1	24,80

## Terrines LPS «Le Parfait Super»



Les terrines Le Parfait Super offrent le meilleur contenant pour pâtés, rillettes et autres préparations maison. Le modèle préféré des professionnels de la restauration, grâce à sa forme conique, parfaite pour démouler facilement toutes les recettes !



Pack de 6 terrines avec joint

Désignation	Code	g	Ø x Ht cm	SUR.	Prix HT
6 terrines avec joint	15 10 024	125	8,33 x 7,34	1	15,95
	15 10 025	200	8,33 x 8,65	1	16,85
	15 10 026	350	8,7 x 9,9	1	18,50
	15 10 027	500	9,2 x 10,7	1	23,95
	15 10 028	750	10 x 13,7	1	25,65
	15 10 029	1000	10 x 17,15	1	28,15



## Bocaux LPS «Le Parfait Super»

Les bocaux Le Parfait Super, de part leur forme arrondie, leur rondelle et leur monture métallique à toute épreuve sont idéaux pour conserver fruits et légumes que ce soit au naturel, au sirop ou en soupes. Multi-usages, ils se prêtent aussi à la fermentation. Disponibles en grands formats, ils font d'excellents bocaux pour vos réserves.



## Bouteilles Le Parfait

Le Parfait propose une famille complète de bouteilles en verre pour conserver les boissons, avec deux systèmes de fermeture. D'un côté le swing-top, allié conservation et service des eaux et jus. De l'autre, la bouteille fraîcheur, idéale pour la vente à emporter.



**A. "Fraîcheur"**  
avec couvercle Twist off

**B. "Swing top"**  
fermeture mécanique jumper

Désignation	Code	Ccl	ø. x Ht. cm	SUR.	Prix HT
A. Twist off	15 10 235	50	6,7 x 19	6	1,55
	15 10 236	100	8,4 x 25,2	6	1,80
B. Swing top	15 10 230	50	6,5 x 28	3	2,75
	15 10 231	100	8,5 x 34	3	3,20



## Confituriers «Le Parfait»

Des bocaux spécialement conçus pour conserver les confitures.



**C. Pot avec**  
couvercle plastique (x6)

**D. Pot avec**  
couvercle métal (x6)

**E. Pot avec**  
couvercle métal (x8)

Code	Pack	Ccl	ø. x Ht. cm	SUR.	Prix HT
C. 12 10 193	6 pots	32,4	8,5 x 9,5	1	8,45
D. 12 10 189	6 pots	32,4	8,5 x 9	1	6,85
D. 12 10 190	6 pots	38,5	8,5 x 11	1	8,45
Offre avec gratuits 6+2					
E. 15 10 258	6 + 2 pots	32,4	8,5 x 9	1	8,15
E. 15 10 259	6 + 2 pots	38,5	8,5 x 11	1	6,45

## Accessoires



**F. Couvercle**

**G. Sachet de 6**  
couvercles

**H. Lot de 10**  
capsules

**I. Lot de 2**  
marqueurs

Désignation	Code	Ø cm	SUR.	Prix HT
F. Lot 6 couvercles	12 10 191	8,2	40	3,85
F. Lot 18 couvercles	12 10 185	8,2	15	11,55
G. Sachet 6 couvercles	15 10 240	8,2	20	4,70
	15 10 241	10	15	6,65
	15 10 242	11	15	7,35
	15 10 070	8,2	24	6,95
H. Lot 10 capsules	15 10 071	10	12	8,57
	15 10 072	11	12	10,65
	15 10 248	feutres blancs	18	4,15

## Accessoires «Le Parfait»

Des accessoires parfaitement adaptés aux produits Le Parfait. Compagnons indispensables des bocaux, terrines et confituriers Le Parfait, les rondelles, capsules et couvercles permettent de réaliser et conserver vos préparations sereinement.



**J. Sachet de 10**  
**rondelles universelles**  
convient aux terrines 500, 750,  
1000 et bocal 3 L



**L. Sachet de 10**  
**rondelles universelles**  
convient aux terrines 125 cl et 250 cl



**N. Sachet 10 de**  
**rondelles 2 oreilles**  
Convient aux terrines 350 g et les  
bocaux 0,5 / 0,75 / 1 / 1,5 et 2 L



**P. Tire rondelle**



**Q. Sachet de**  
**27 étiquettes**

**K. Sachet de 10**  
**rondelles universelles**  
Convient aux bocaux 0,5L / 0,75 L / 1 L /  
1,5 L / 2 L et terrine 350 LPS

**M. Sachet de 30**  
**rondelles universelles**  
Convient aux terrines 350 g et les  
bocaux 0,5 / 0,75 / 1 / 1,5 et 2 L

**O. Sachet de 10**  
**rondelles universelles**  
Convient aux terrines 125 / 200 / 250 g  
et les bocaux 0,5 L

Code	Pack	ø cm	SUR.	Prix HT
J. 15 10 062	10 rondelles	10	20	2,95
K. 15 10 061	10 rondelles	8,5	20	4,50
L. 15 10 060	10 rondelles	7	20	2,40
M. 15 10 096	30 rondelles	8,5	20	7,70

Code	Pack	ø cm	SUR.	Prix HT
N. 15 10 064	10 rondelles 2 oreilles	8,5	20	2,95
O. 15 10 052	10 rondelles 2 oreilles	7	50	2,85
P. 15 10 250	Tire rondelle		50	5,10
Q. 12 10 112	27 étiquettes adhésives		50	3,25

**Colorama - Friteuse à air chaud** 

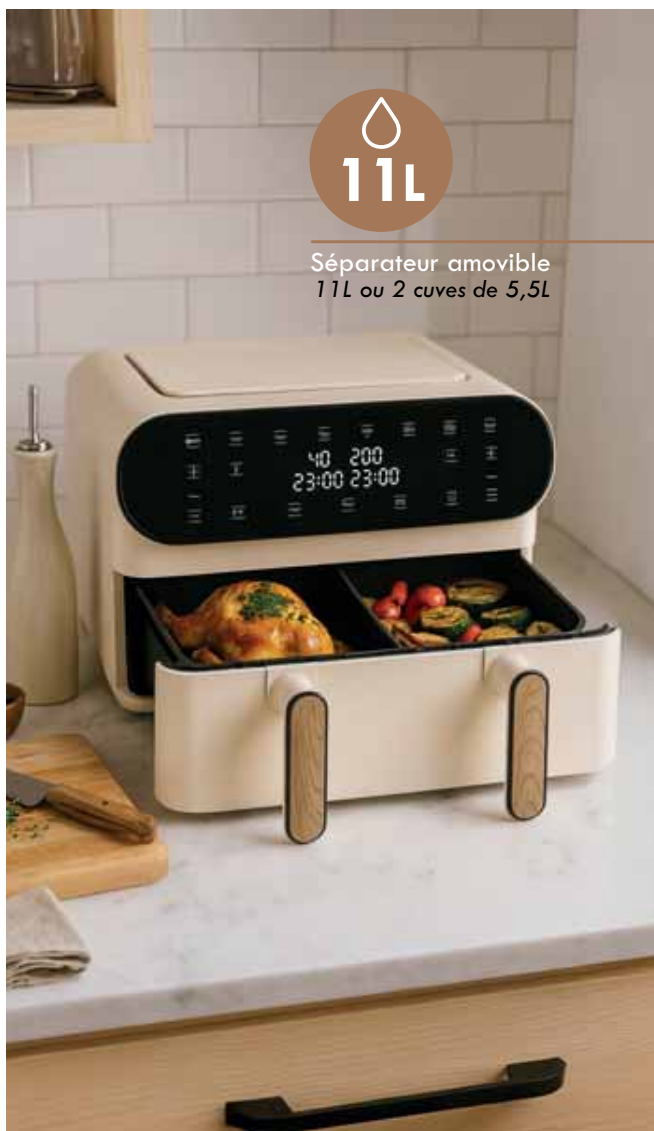

  
**11L**

Séparateur amovible  
11L ou 2 cuves de 5,5L



  
**5L**

  
**5L**



Friteuse à air chaud double zone beige

Désignation	Code	Litres	L x l x Ht cm	SUR.	Prix HT
Friteuse double zone	60 25 025	11	40 x 39 x 30	1	142,50

**Accessoires - Friteuse à air chaud**



Moule silicone rectangule



Moule silicone carré



Moules papier (x50)



Panier cuisson



Moule cuisson

Désignation	Code	L x l x Ht cm	SUR.	Prix HT
Moule silicone rectangule	60 20 012	23 x 15 x 4,5	12	4,70
Moule silicone carré	60 20 013	20 x 20 x 3,8	12	4,70
Moules papier (x50)	50 40 103	20 x 20 x ?	10	2,70

Désignation	Code	Ø x Ht cm	SUR.	Prix HT
Panier cuisson	60 20 672	20 x 7	6	3,60
Moule cuisson	60 20 671	20 x 2,5	2,5	1,95



## Colorama - Friteuse à air chaud

8 PROGRAMMES  
DE CUISSON230V  
1500WÉCRAN LED  
TACTILE  
INTUITIFMontée en  
température rapide  
Short heating timeMinuterie d'1h  
One-hour timer80°C  
200°CTempérature  
réglable jusqu'à 200°C  
Temperature adjustable  
up to 200°CGrille antiadhésive  
Non-stick grill  
Ø 22,5 cmPieds antidérapants  
Non-slip feetPoignée en bakélite  
effet bois  
Wood effect bakelite  
handleSOFT  
TOUCHCuve amovible  
Borosilicate glass lid  
22,5 x 10,3 cm

4/6



4.5L

Désignation	Litres	Code	Ø x Ht cm	SUR.	Prix HT
● Safran	4,5	60 25 003	25 x 31	1	74,95
● Crème	4,5	60 25 004	25 x 31	1	74,95
● Céladon	4,5	60 25 001	25 x 31	1	74,95
● Rose	4,5	60 25 007	25 x 31	1	74,95
● Magenta	4,5	60 25 002	25 x 31	1	74,95
● Olive	4,5	60 25 006	25 x 31	1	74,95



Crème

Rose

Céladon



Safran

Magenta

Olive



## Machine sous vide

Puissance réglable grâce à la fonction d'impulsion : réduit la dépression à l'intérieur du sachet pour éviter d'écraser les aliments. Fournie avec 10 sacs inclus 20 x 30 cm.

**LEIFHEIT**



**Vacu power 100 4L/min**

Code	Watt	L x l x Ht cm	SUR.	Prix HT
02 12 002	100	37,8 x 6,6 x 10,3	3	79,20 EC : 0,11



**Vacu power 300 9L/min**

Code	Watt	L x l x Ht cm	SUR.	Prix HT
02 12 003	300	36 x 8,7 x 16,5	2	111,95 EC : 0,21



**Set 3 boîtes sous vide**

Code	L x l cm ou ml	SUR.	Prix HT
02 12 005	500/800/1400	4	71,93

Le set comprend 3 boîtes fraîcheurs sous vide de 500 mL, 800 mL et 1400 mL sans BPA. Muni d'un tuyau adaptateur compatible avec toutes les machines Leifheit. Convient au lave vaisselle, et congélateur jusqu'à -20°C.



**Vacu power 500 12L/min**

Code	Watt	L x l x Ht cm	SUR.	Prix HT
02 12 001	500	39,5 x 9,5 x 21,5	2	153,19 EC : 0,21



**Percolateur à café**

Code	Φ x Ht cm	SUR.	Prix HT
46 10 868	32,2 x 47,2	3	213,50

Percolateur permettant de préparer jusqu'à 12 tasses de café. Facile à utiliser, il maintient le café chaud pendant plusieurs heures et assure une bonne qualité de boisson grâce à son système de filtration.



**Blender professionnel \***

Code	L x l x Ht cm	SUR.	Prix HT
46 10 835	23 x 20,5 x 5,1	1	543,94 EC : 0,71

Mixeur de haute qualité, 950W. Poids 5 kg. Capacité 2L. Vitesses variables 13 300-26 600 et 38 000 tours/min. Fonction pulse glace pilée, 3 programmations 35, 60 et 90 sec. Bloc couteaux 6 lames multidirectionnelles. Possibilités d'ajouter des aliments en cours de préparation grâce au couvercle.



**Corps de chauffe électrique 92°C pour chafing dish**

Code	Watt	L x l cm	SUR.	Prix HT
46 10 830	700	20 x 25	1	235,00

Avec régulateur.



**Chafing Dish**

Code	Ccl	L x l x Ht cm	SUR.	Prix HT
46 10 828	850	56 x 35 x 28	1	116,85

Chafing Dish basic inox GN 1/1 avec couvercle. Supports de brûleurs fournis pour gel de chauffe 225gr Ethanol. Autonomie 3h.





Cafetière crème 12 tasses

Code	Litres	L x l x Ht cm	SUR.	Prix HT
60 25 050	1,5	18 x 27 x 30	6	21,90 EC : 0,46



Bouilloire crème 1,7L

Code	Litres	L x l x Ht cm	SUR.	Prix HT
60 25 051	1,7	15,7 x 18,5 x 24,6	6	20,70 EC : 0,34



Grille-Pain crème 2 fentes

Code	L x l x Ht cm	SUR.	Prix HT
60 25 052	19 x 29 x 21	6	23,95 EC : 0,18



Cafetière Includeo Noir 1,25 L

Code	Ccl	Φ x Ht cm	SUR.	Prix HT
42 12 103	125	23,1 x 22,6 x 34	2	62,38 EC : 0,20

Design inclusif pensé pour une utilisation facile par tous. Porte-filtre amovible avec double poignée pour une prise en main optimale. Poignée ergonomique et base stable pour plus de sécurité. Large réservoir d'eau avec indicateurs faciles à lire. Bouton marche/arrêt simple d'utilisation.

Tefal



Grille pain Includeo

Code	L x l x Ht cm	SUR.	Prix HT
42 12 202	27,2 x 17,1 x 18,8	4	62,38 EC : 0,25

Grille-pain ergonomique avec 2 fentes extra-larges adaptées à tous types de pains. Commandes à haute visibilité et lisibilité pour une utilisation facile. Pince de préhension avec une face en silicone et levier de surélévation pour retirer les tranches en toute sécurité. 7 niveaux de dorage réglables.

Tefal



Bouilloire 1,7L

Code	Couleur	L x l x Ht cm	SUR.	Prix HT
60 25 055	Crème	28,6 x 31,2 x 18,9	8	27,50
60 25 056	Céladon	28,6 x 31,2 x 18,9	8	27,50
60 25 057	Brique	28,6 x 31,2 x 18,9	8	27,50
60 25 058	Bleu	28,6 x 31,2 x 18,9	8	27,50
60 25 059	Rose	28,6 x 31,2 x 18,9	8	27,50

Puissance 1850-2200W. Ultra compacte et très pratique.

Boîtier thermorésistant, sans fil avec rotation 360°, bouton d'alimentation LED et ouverture du couvercle intégrée à la poignée.

## Les couverts

since 1953  
**Amefa**



### Havane

Design léger et moderne forme en arc tendu

**OGO**  
LIVING



### Filla

Classique et élégant, le filet souligne le contour et l'harmonie

**OGO**  
LIVING



### Arès

Design graphique et intemporel avec le jeu de lignes asymétriques

tehrin



### Tamtam

Effet modelé avec une finition poli



04

## COUVERTS



Couverts séries	222 à 233
Couteaux à steak	234 à 235
Cuillères	236
Fruits de mer	237

**Valmy 1.5mm**

Finition standard, inox 18.0

SINCE 1931  
**Amefa**

Désignation	Code	Long cm	Sur.	Prix HT
A . Fourchette	48 35 980	20	12	0,36
B . Cuillère table	48 35 981	20,3	12	0,36
C . Cuillère café	48 35 982	13,3	12	0,20
D . Couteau table	48 35 983	21,8	12	0,66
E . Couteau à steak	48 35 988	22,4	12	1,52
Fourchette dessert	48 35 984	17,2	12	0,47
Cuillère dessert	48 35 985	17,2	12	0,47
Couteau dessert	47 10 248	20,3	12	0,77
Fourchette huître	48 35 986	13	12	0,32
Fourchette escargot	48 35 987	13,5	12	0,46
Fourchette tapas	48 35 989	13,5	12	0,31
Cuillère moka	48 35 990	11	12	0,12

**Amsterdam 2.2mm**

Finition satinée, inox 18.0

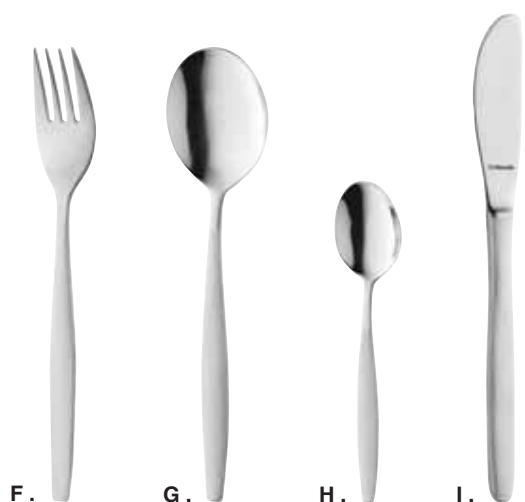

Désignation	Code	Long cm	Sur.	Prix HT
F . Fourchette	47 35 541	19	12	1,36
G . Cuillère table	47 35 542	17,8	12	1,36
H . Cuillère café	47 35 543	13,8	12	1,19
I . Couteau	47 35 544	20	12	2,86

**Resto 2mm**

Finition standard, inox 18.0

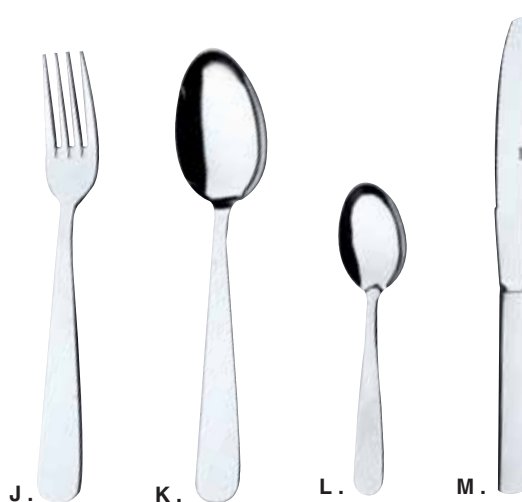
SINCE 1931  
**Amefa**

Désignation	Code	Long cm	Sur.	Prix HT
J . Fourchette	47 35 110	20	12	0,58
K . Cuillère table	47 35 111	20,3	12	0,58
L . Cuillère café	47 35 112	13,2	12	0,25
M . Cout. monobloc	47 35 113	22	12	0,98
Couteau cranté	47 35 018	22,6	12	1,34

**Ocean 1.8mm**

Finition standard brillant, inox 18.0

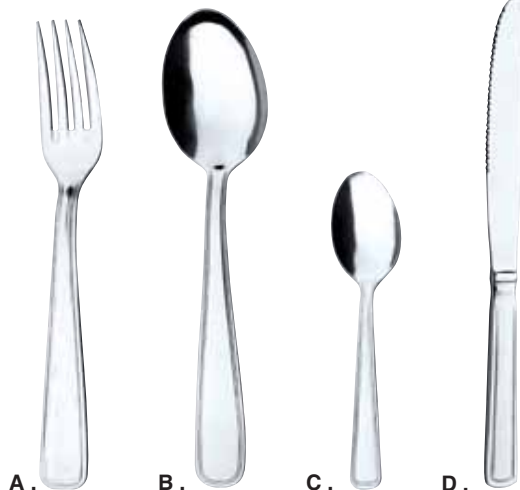

Désignation	Code	Long cm	Sur.	Prix HT
A . Fourchette table	47 10 001	20,5	12	0,86
B . Cuillère table	47 10 002	20	12	0,86
C . Cuillère café	47 10 003	13,5	12	0,52
D . Couteau table	47 10 004	22	12	1,85

**Olga 1.8mm**

Finition brillant, inox 18.0



Désignation	Code	Long cm	Sur.	Prix HT
E . Fourchette table	47 10 092	19,5	12	0,56
F . Cuillère table	47 10 093	19,3	12	0,56
G . Cuillère café	47 10 091	12,8	12	0,32
H . Cout. Monobloc	47 10 088	21	12	1,36
Cuil.soda Mazagran	47 10 090	17,7	12	0,62
Cuillère moka	47 10 089	11,3	12	0,30
Couteaux steak	47 10 094	21,5	12	2,25

tehrin

**Contour 2mm**

Finition brillant, inox 18.0



Désignation	Code	Long cm	Sur.	Prix HT
I . Fourchette	47 10 220	21	12	0,89
J . Cuillère table	47 10 221	20,7	12	0,89
K . Cuillère café	47 10 222	14,2	12	0,47
L . Couteau	47 10 223	22,5	12	2,97
Fourchette dessert	47 10 225	18	12	0,89
Cuillère dessert	47 10 226	18	12	0,89

tehrin

**Drakkar 2mm**

Finition miroir, inox 18.0

tehrin



Désignation	Code	Long cm	Sur.	Prix HT
A . Fourchette	47 10 970	20,1	12	1,21
B . Cuillère table	47 10 971	19,7	12	1,21
C . Cuillère café	47 10 972	13,6	12	0,94
D . Cout. monobloc	47 10 973	20,8	12	2,10
Cuillère moka	47 10 980	11,7	12	0,97
Cuil.soda Mazagran	47 10 978	22,5	12	1,53
Cuil.coudée Mazag.	47 10 979	19,2	12	1,53

**Slim 0.5mm**

Finition standard, inox 18.0

**Manille 2mm**

Finition standard, inox 18.0

Amefa

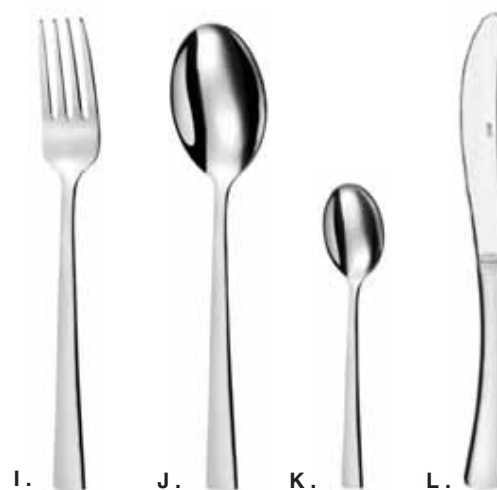

Désignation	Code	Long cm	Sur.	Prix HT
<b>Lot de 12 pièces</b>				
E . Fourchette table	47 40 153	16,5	20	2,45
F . Cuillère table	47 40 154	16,5	40	2,34
G . Cuillère café	47 40 155	12,5	40	1,95
H . Couteau table	47 40 152	16,5	20	2,94
Fourchette dessert	47 40 156	12	40	2,13

Désignation	Code	Long cm	Sur.	Prix HT
I . Fourchette table	47 35 370	20,5	12	0,63
J . Cuillère table	47 35 371	20,5	12	0,63
K . Cuillère café	47 35 372	13,5	12	0,36
L . Couteau table	47 35 373	22	12	1,10

**Tradition 2mm**

Finition standard, inox 18.0

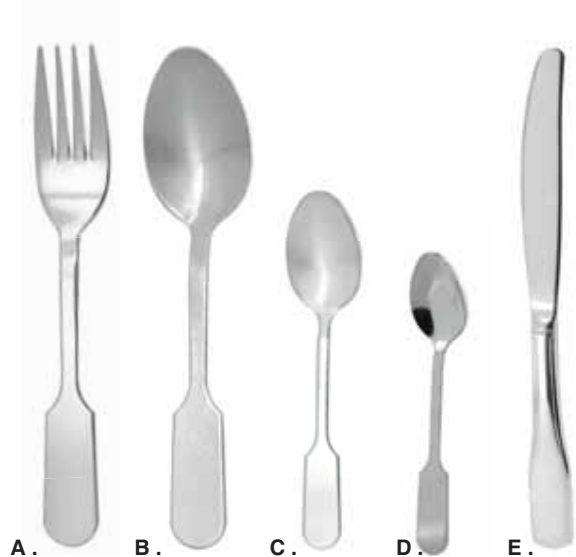

Désignation	Code	Long cm	Sur.	Prix HT
A. Fourchette	47 12 005	20	12	0,48
B. Cuillère table	47 12 006	20	12	0,48
C. Cuillère dessert	47 12 008	17,5	12	0,48
D. Cuillère café	47 12 007	14	12	0,23
E. Couteau table	47 12 009	23,5	12	1,83

**Vieux Paris 2.5mm**

Finition satinée, sans virgule, inox 18.0



Désignation	Code	Long cm	Sur.	Prix HT
F. Fourchette	47 10 385	20,7	12	1,87
G. Cuillère table	47 10 386	21	12	1,87
H. Cuillère café	47 10 387	13,8	12	1,29
I. Couteau monobloc	47 10 388	23,3	12	3,22
Cout. dess. monobloc	47 10 389	20,5	12	3,22
Cuillère dessert	47 10 391	17,4	12	1,87

**Lutécia 2mm**

Finition miroir, sans virgule, inox 18.0

lehrin

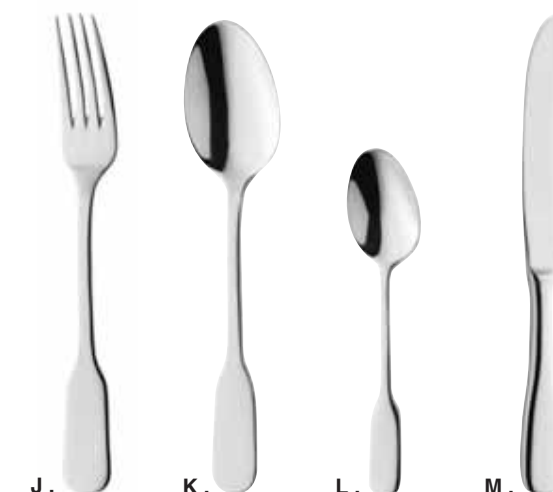

Désignation	Code	Long cm	Sur.	Prix HT
J. Fourchette	47 10 491	19,5	12	1,44
K. Cuillère table	47 10 492	19,5	12	1,44
L. Cuillère à café	47 10 493	14	12	1,04
M. Couteau tradition	47 12 009	23,5	12	1,83
Cuillère dessert	47 10 498	27	12	0,84

**Adonis 2mm**

Finition miroir, Inox 18.0.

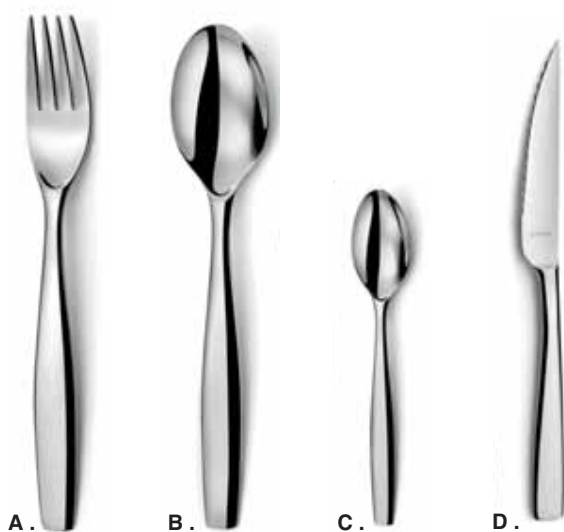

Désignation	Code	Long cm	Sur.	Prix HT
A . Fourchette	47 35 662	20	12	1,51
B . Cuillère table	47 35 663	20	12	1,51
C . Cuillère café	47 35 664	13,6	12	1,06
D . Couteau table	47 35 665	22	12	2,99
Couteau steak	47 35 666	22	12	2,99
Fourchette dessert	47 35 667	18	12	1,51
Cuillère dessert	47 35 668	18	12	1,51
Couteau dessert	47 35 669	19,8	12	2,97
Couteau poisson	47 35 670	20,3	12	1,51

**Adonis icy 2mm**

Finition glace, Inox 18.0.

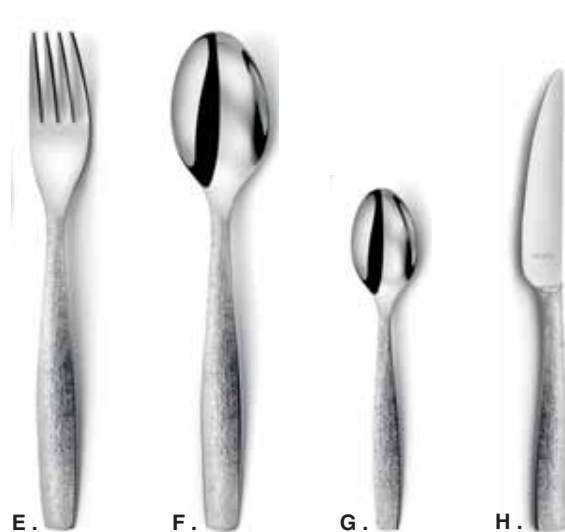

Désignation	Code	Long cm	Sur.	Prix HT
E . Fourchette	47 35 676	20	12	1,59
F . Cuillère table	47 35 677	20	12	1,59
G . Cuillère café	47 35 678	13,6	12	1,12
H . Couteau table	47 35 679	22	12	3,13
Fourchette dessert	47 35 680	18	12	1,51
Cuillère dessert	47 35 681	18	12	1,51
Couteau dessert	47 35 682	19,8	12	2,97

**Canisse Bambou 3mm**

Finition miroir, inox 18.0

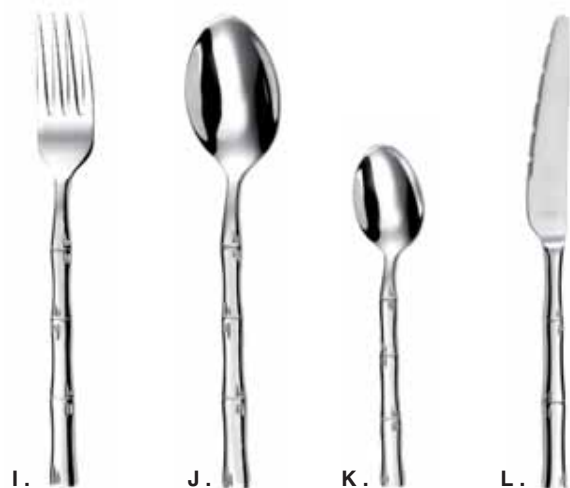

Désignation	Code	Long cm	Sur.	Prix HT
I . Fourchette	47 35 578	20	12	1,57
J . Cuillère table	47 35 579	19,7	12	1,57
K . Cuillère café	47 35 580	14,6	12	1,27
L . Couteau	47 35 581	23,3	12	2,69

**INSTINCT 2mm**

Finition brillant, Inox 18.0.

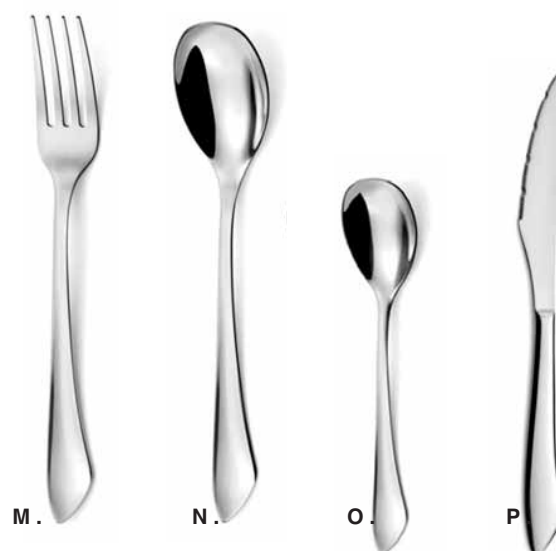

Désignation	Code	Long cm	Sur.	Prix HT
M . Fourchette	47 35 380	20,4	12	1,28
N . Cuillère table	47 35 381	20,2	12	1,28
O . Cuillère café	47 35 382	13,8	12	0,95
P . Couteau table	47 35 383	22,2	12	2,13

New products  
Nouveautés

**Ambition 2mm**

Finition miroir, inox 18.0.

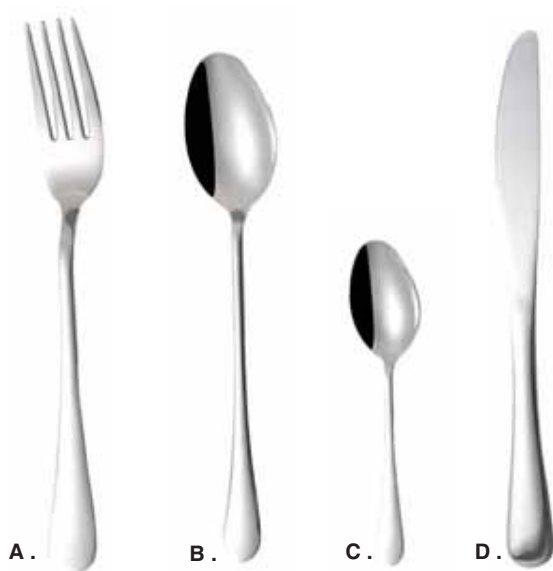
**Louise 3mm**

Finition miroir, inox 18.0.



Désignation	Code	Long cm	Sur.	Prix HT
A . Lot de 4 Fourchette	47 25 331	20	6	Le set 2,73
B . Lot de 4 Cuillère table	47 25 332	20	6	2,73
C . Lot de 4 Cuillère café	47 25 333	14,5	6	1,85
D . Lot de 2 Couteaux	47 25 330	22	6	2,19

Désignation	Code	Long cm	Sur.	Prix HT
E . Fourchette de table	47 25 381	20,5	6	0,99
F . Cuillère table	47 25 382	19,6	6	0,99
G . Cuillère café	47 25 383	14	6	0,65
H . Couteau	47 25 384	22,5	6	0,99
Menagère 16 pièces	47 25 380		6	12,95

**Suva bois**

Désignation	Code	Sur.	Prix HT
Suva bois 24 pièces	47 25 297	3	24,95

**Lima Inox**

Désignation	Code	Sur.	Prix HT
Lima inox 24 pièces	47 25 275	3	17,95

**Lina Crème brique céladon**

Désignation	Code	Sur.	Prix HT
Lina Brique 24 pièces	47 25 349	3	22,50
Lina Céladon 24 pièces	47 25 344	3	22,50
Lina Crème 24 pièces	47 25 339	3	22,50

## Caractère 4mm

Finition miroir, acier inoxydable 18.0

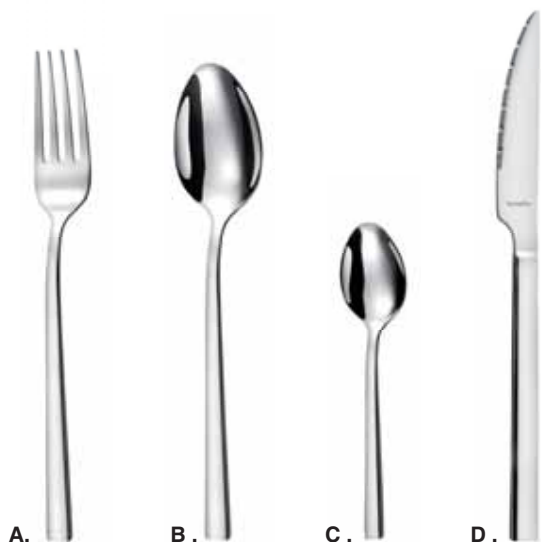

Désignation	Code	Long cm	Sur.	Prix HT
A . Fourchette table	47 35 040	20,8	12	2,13
B . Cuillère table	47 35 041	20,5	12	2,13
C . Cuillère café	47 35 042	14,5	12	1,42
D . Couteau steak	47 35 043	23,3	12	3,22
Fourchette dessert	47 35 045	18,2	12	2,03
Cuillère dessert	47 35 046	18,5	12	2,03
Couteau dessert	47 35 047	20,5	12	2,94

## Carlton A forgé

Finition miroir, Inox 18.0.

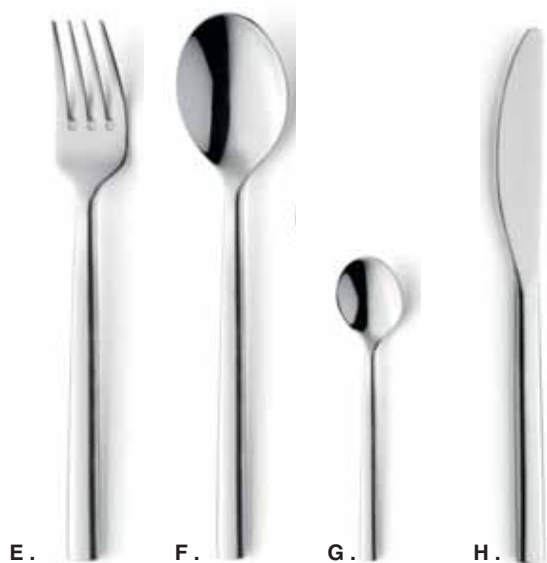

Désignation	Code	Long cm	Sur.	Prix HT
E . Fourchette	47 35 530	19,5	12	2,30
F . Cuillère table	47 35 531	19,7	12	2,30
G . Cuillère café	47 35 532	14,2	12	1,58
H . Couteau table	47 35 533	21,2	12	2,86
Couteau steak	47 35 534	21,5	12	2,86
Fourchette dessert	47 35 535	18	12	2,18
Cuillère dessert	47 35 536	18	12	2,19
Couteau dessert	47 35 537	20	12	2,72

**Athéna 3mm**

Finition miroir, Inox 18.0.

**OGO**  
LIVING

A .

B .

C .

D .

Désignation	Code	Long cm	Sur.	Prix HT
A. Fourchette table	47 12 039	21	12	1,80
B. Cuillère table	47 12 044	21	12	1,80
C. Cuillère café	47 12 046	14	12	1,05
D. Couteau table	47 12 036	23	12	2,75
Fourchette poisson	47 12 040	19	12	1,44
Couteau poisson	47 12 037	21	12	1,44
Fourchette dessert	47 12 043	19	12	1,30
Cuillère dessert	47 12 045	19	12	1,70
Couteau dessert	47 12 038	20,5	12	2,02
Cuillère moka	47 12 047	10,5	12	0,73
Couteau steak	47 12 035	23	12	2,30

**Ariane 3mm**

Finition miroir, Inox 18.0.

since 1931  
**Amefa****Jet 2.5mm**

Finition brillant, Inox 18.0.

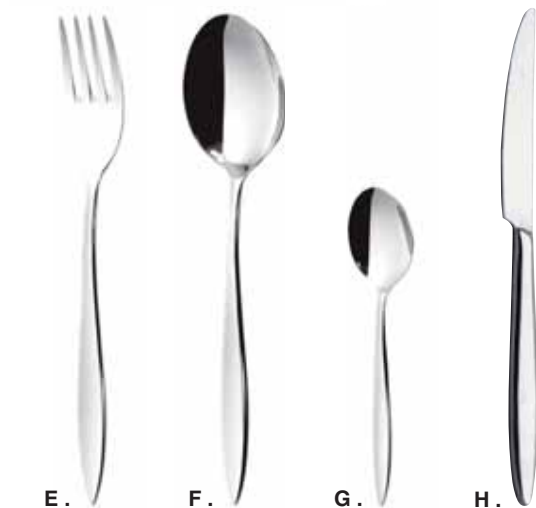
*Lou Laquière®*

E .

F .

G .

H .

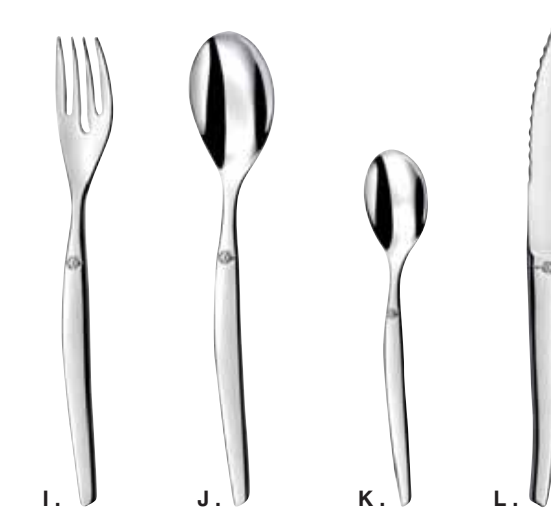

I .

J .

K .

L .

Désignation	Code	Long cm	Sur.	Prix HT
E . Fourchette	47 10 860	20,5	12	1,70
F . Cuillère table	47 10 861	20,6	12	1,70
G . Cuillère café	47 10 862	13,7	12	0,82
H . Couteau table	47 10 863	23	12	2,96

Désignation	Code	Long cm	Sur.	Prix HT
I . Fourchette	47 35 570	20,7	12	1,63
J . Cuillère table	47 35 571	20,7	12	1,63
K . Cuillère café	47 35 572	14	12	1,38
L . Couteau	47 35 573	22,4	12	3,32
Fourchette dessert	47 35 574	17,8	12	1,60
Cuillère dessert	47 35 575	18	12	1,61
Couteau dessert	47 35 576	19,5	12	3,13

## Havane 3mm

Finition miroir, inox 18.0.



Désignation	Code	Long cm	Sur.	Prix HT
A . Fourchette	47 35 451	20,7	12	1,79
B . Cuillère table	47 35 452	20,5	12	1,79
C . Cuillère café	47 35 453	13,5	12	0,84
D . Couteau	47 35 454	23,5	12	2,67
Fourchette dessert	47 35 455	17,7	12	1,68
Cuillère dessert	47 35 456	17,7	12	1,68

## Havane Jungle 3mm

Décor gravé 2 faces, acier inoxydable 18.0

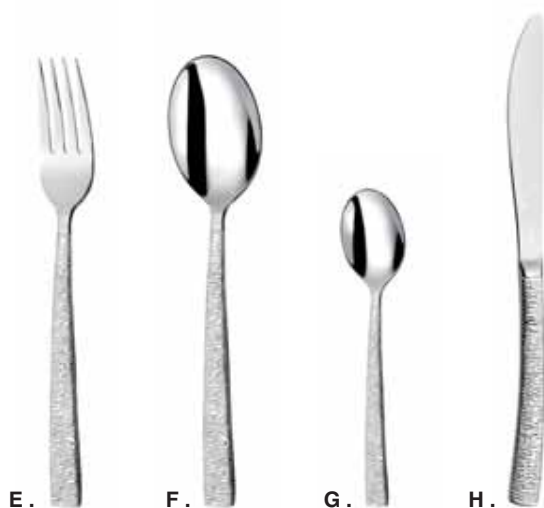

Désignation	Code	Long cm	Sur.	Prix HT
E . Fourchette	47 35 180	20,7	12	1,97
F . Cuillère table	47 35 181	20,5	12	1,97
G . Cuillère café	47 35 182	13,5	12	0,91
H . Cout.monobloc	47 35 183	23,5	12	2,89
Fourchette dessert	47 35 185	17,7	12	1,88
Cuillère dessert	47 35 186	17,6	12	1,88

## Métropole 4mm

Finition miroir, Inox 18.10

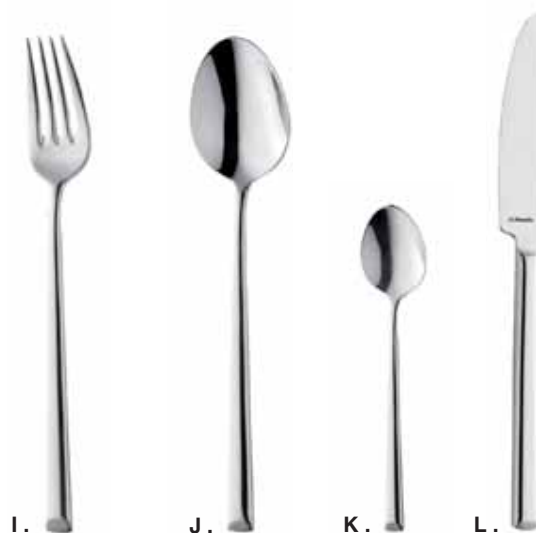

Désignation	Code	Long cm	Sur.	Prix HT
I . Fourchette	47 38 125	21,1	12	4,46
J . Cuillère table	47 38 126	21	12	4,46
K . Cuillère café	47 38 127	14	12	3,07
L . Couteau	47 38 128	22,5	12	6,39
Fourchette dessert	47 38 131	19,4	12	4,18
Cuillère dessert	47 38 132	19,2	12	4,18
Couteau dessert	47 38 133	20,5	12	6,02
Cuillère moka	47 38 134	11,5	12	2,90

## Arès Vintage 3mm

Finition patiné, inox 18.0.

**OGO**  
LIVING

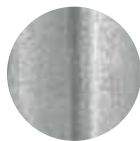

A . B . C . D .



Désignation	Code	Long cm	Sur.	Prix HT
A . Fourchette table	47 12 086	20,5	12	1,55
B . Cuillère table	47 12 087	20,5	12	1,55
C . Cuillère café	47 12 088	14	12	0,90
D . Couteau steak	47 12 085	22,5	12	2,90

## Arès 3mm

Finition miroir, inox 18.0.

**OGO**  
LIVING

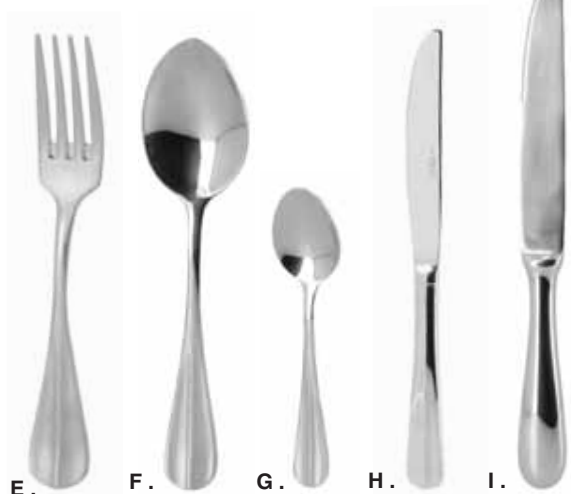

E . F . G . H . I .

Désignation	Code	Long cm	Sur.	Prix HT
E . Fourch. table	47 12 075	20,5	12	1,55
F . Cuillère table	47 12 078	20,5	12	1,55
G . Cuillère café	47 12 080	13,8	12	0,90
H . Couteau table	47 12 072	23,5	12	2,80
I . Couteau orfèvre	47 12 071	25	12	6,27
Couteau steak	47 12 070	20,5	12	2,95
Fourchette dessert	47 12 077	18,5	12	1,45
Cuillère dessert	47 12 079	18,5	12	1,45
Couteau dessert	47 12 074	20,5	12	2,85
Fourchette poisson	47 12 076	18,5	12	1,45
Couteau poisson	47 12 073	20,5	12	1,65
Cuillère moka	47 12 081	10,5	12	0,85
Cuillère soda	47 12 082	20	12	2,15

## Baguette 2.5mm

Finition miroir, inox 18.0.

**Amefa**  
since 1931

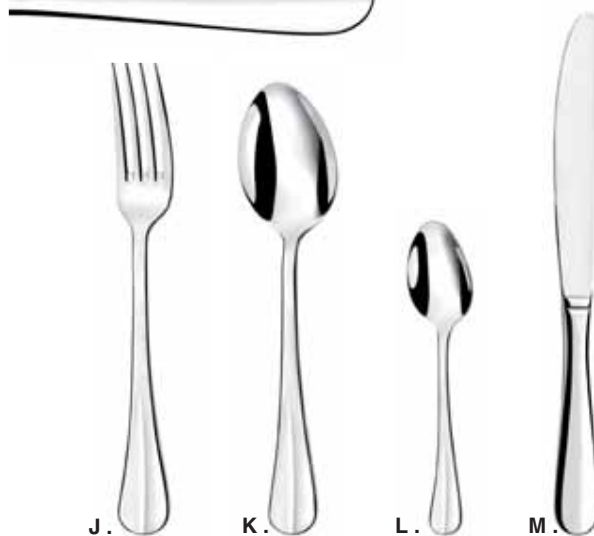

J . K . L . M .

Désignation	Code	Long cm	Sur.	Prix HT
J . Fourchette	47 35 050	21	12	1,98
K . Cuillère table	47 35 051	21	12	1,98
L . Cuillère café	47 35 052	14	12	1,16
M . Couteau table	47 35 053	23,5	12	2,84
Cuillère moka	47 35 060	12,5	12	1,10
Couteau steak	47 12 070	22,5	12	2,95

**Tam Tam 3mm**

Finition martelée, acier 18.0.

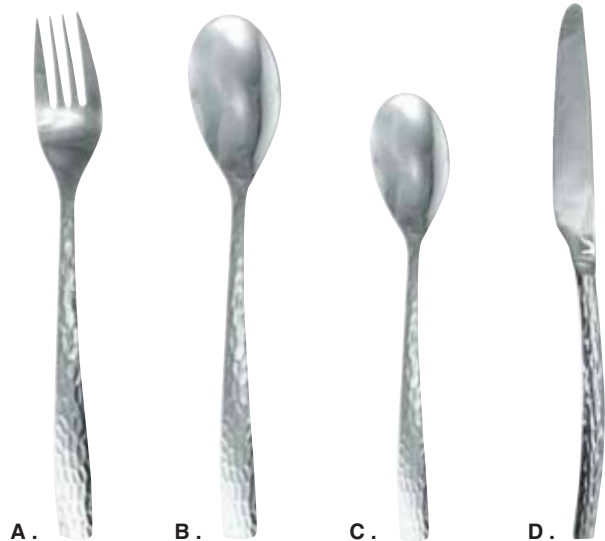

lehrun



Désignation	Code	Long cm	Sur.	Prix HT
A . Fourchette	47 11 810	21	12	2,10
B . Cuillère table	47 11 811	21	12	2,10
C . Cuillère café	47 11 812	14	12	1,31
D . Couteau	47 11 813	23	12	2,75
Couteau steak	47 11 814	22	12	3,42
Fourchette dessert	47 11 815	18	12	2,10
Cuillère dessert	47 11 816	18	12	2,10
Couteau dessert	47 11 817	20,5	12	2,75
Cuillère moka	47 11 821	12	12	1,16

**Esmeralda 2.5mm**

Finition poli-glace inox 18.0, le manche courbé, stylé et moderne.

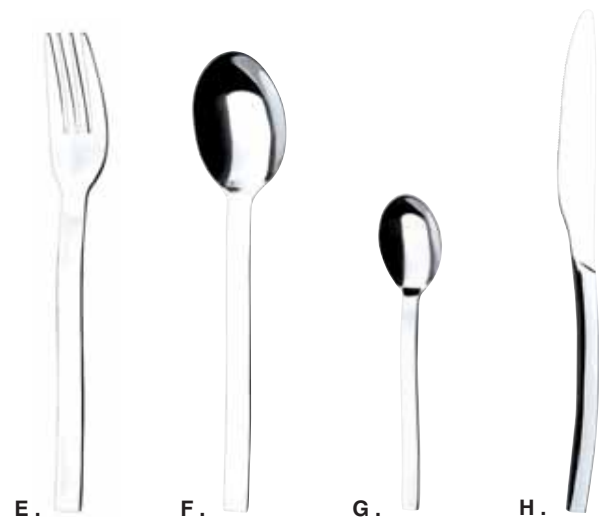

Désignation	Code	Long cm	Sur.	Prix HT
E . Fourchette	47 10 820	20,6	12	1,83
F . Cuillère table	47 10 821	20,4	12	1,83
G . Cuillère café	47 10 822	14,5	12	1,29
H . Couteau	47 10 823	23	12	2,62
Couteau steak monobloc	47 10 824	22	12	3,42
Fourchette dessert	47 10 825	19	12	1,83
Cuillère dessert	47 10 826	19	12	1,83
Couteau dessert monobloc	47 10 827	20,5	12	2,62

**Cabana 3mm**

Finition miroir, Inox 18.0.



Désignation	Code	Long cm	Sur.	Prix HT
I . Fourchette	47 10 932	20,4	12	2,00
J . Cuillère table	47 10 933	20,5	12	2,00
K . Cuillère café	47 10 934	14,2	12	1,29
L . Couteau	47 10 935	23	12	2,62
M . Couteau steak	47 10 937	23	12	3,42
Couteau dessert	47 10 936	20,5	12	2,62
Fourchette dessert	47 10 938	18	12	2,00
Cuillère dessert	47 10 939	18,5	12	2,00



## Nature forgé 6mm

Finition miroir, acier 18.0.



Désignation	Code	Long cm	Sur.	Prix HT
A. Fourchette table	47 12 063	19,4	12	1,90
B. Cuillère table	47 12 065	19,4	12	1,90
C. Cuillère café	47 12 066	13,4	12	1,35
D. Couteau table	47 12 061	21,3	12	2,15
Fourchette dessert	47 12 064	18	12	1,70
Cuillère dessert	47 12 067	18	12	1,75
Couteau steak	47 12 060	22	12	2,25
Couteau dessert	47 12 062	19,5	12	1,95

## Filla 3mm

Finition miroir, Inox 18.0.

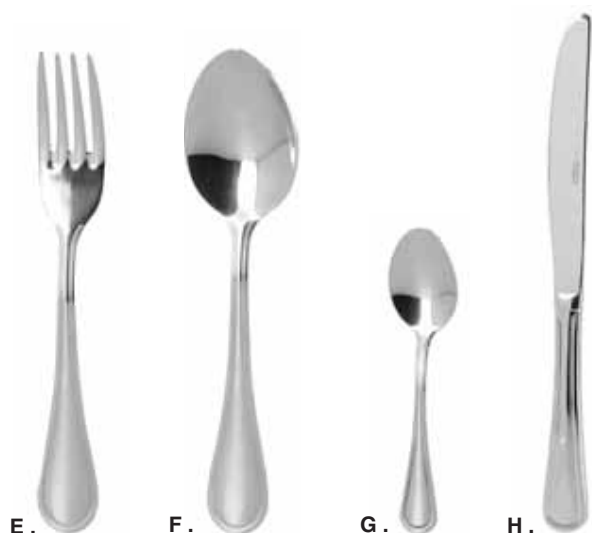

Désignation	Code	Long cm	Sur.	Prix HT
E. Fourchette table	47 12 019	21	12	2,15
F. Cuillère table	47 12 023	21	12	1,73
G. Cuillère café	47 12 024	14	12	1,04
H. Couteau table	47 12 016	24	12	2,27
Couteau steak	47 12 015	22,3	12	2,95
Fourchette dessert	47 12 020	18,5	12	1,60
Cuillère dessert	47 12 025	18,5	12	1,25
Couteau dessert	47 12 018	20,3	12	2,15
Fourchette poisson	47 12 027	17,5	12	1,59
Couteau poisson	47 12 017	21	12	1,60
Cuillère moka	47 12 026	11	12	0,88

## Vintage

A . Bongo



B . Tam Tam



C . Croco



D . Goliath



E . Laguiole Jet



F . Tradition Court. laguiole



G . Instinct



Code	Long cm	Sur.	Prix HT
A . 47 35 614	23	6	4,17
B . 47 11 814	23	12	3,42
C . 47 10 712	22	12	1,38
D . 47 35 832	23	6	3,96
E . 47 35 573	22,4	12	3,32
F . 47 40 098	23	6	2,48
G . 47 35 383	22,2	12	2,13



H . Nature



I . Athena



J . Ares



K . Filla



Code	Long cm	Sur.	Prix HT
H . 47 12 060	21,5	12	2,25
I . 47 12 035	22,8	12	2,30
J . 47 12 070	22,5	12	2,95
K . 47 12 015	22	12	2,95

## Monobloc Inox

L . Torero chuletero



M . Virgule brillant



N . Valmy



O . Olga



P . Cabana



Q . Caractère



R . Adonis



Code	Long cm	Sur.	Prix HT
L . 47 10 264	22,7	12	2,56
M . 47 35 013	23	12	4,27
N . 48 35 988	22,4	12	1,51
O . 47 10 094	20,9	12	2,25

Code	Long cm	Sur.	Prix HT
P . 47 10 937	23	12	3,42
Q . 47 35 043	23	12	3,22
R . 47 35 666	22	12	2,99

## Bout rond

S . Resto cranté



T . Steak 2 rivets



U . Steak



Code	Long/lame cm	Sur.	Prix HT
S . 47 35 018	22,6	12	1,34
T . 47 35 753	21,5	12	0,78
U . 47 10 139	20,2	12	0,52



### Affutables

A . Emperor ABS pleine soie 2mm



B . Louchebarn



C . Mont Blanc



D . ACHILLE PAKKA



E . SENSE



F . PIZZA NOIR LAME MARTELÉE



G . VOLCANO



Code	Long cm	Sur.	Prix HT
A . 48 35 028	23,5	12	10,37
B . 47 10 410	23,7/13	12	9,46
C . 48 35 718	23	6	11,00
D . 47 35 828	22,7	6	8,69
E . 47 35 822	22,7	12	5,78
F . 47 35 836	22,7	12	3,14
G . 47 35 823	22,7	12	9,52

### PP

H . Artisan



I . Steak manche noir (lot de 6)



J . Pizza



K . 2 Rivets campagnard



L . Trappeur



M . Pizza



N . Jumbo



O . Steak PP



Code	Long/lame cm	Sur.	Prix HT
H . 47 10 130	22	12	1,68
I . 47 25 008	16 (lot de 6)	12	4,95
J . 47 35 751	20,5	12	0,99
K . 47 35 007	22,5	12	0,86

Code	Long/lame cm	Sur.	Prix HT
L . 47 35 174	24,5/12,4	54	1,41
M . 47 10 287	21,2	12	3,22
N . 47 35 019	25/12	12	4,10
O . 47 10 260	21	12	0,55

### Imitation

P . Steak Bois



Q . Office manche bois



R . Campagnard 2 rivets



S . Steak pizza bois



T . Bambou



U . Steak manche bois (lot de 6)



Code	Long cm	Sur.	Prix HT
P . 47 10 242	20,5/10,5	12	1,06
Q . 50 25 982	19/9	36	1,44
R . 47 35 009	22,5/10	12	1,55

Code	Long cm	Sur.	Prix HT
S . 47 35 026	21	12	3,30
T . 47 10 631	23,3	12	3,93
U . 47 25 009	15 (lot de 6)	12	5,50



## Cuillères

### Soda et glace



A . Sangria



B . Mazagran



C . Soda Drakkar



D . Drakkar coudée



E . Soda Olga

Code	Long cm	Sur.	Prix HT
A . 47 10 126	27	12	1,58
B . 47 10 127	20,5	12	0,92
C . 47 10 978	20	12	1,53
D . 47 10 979	20	12	1,53
E . 47 10 090	17,7	12	0,62

### Cuillères et Moka



J . Moka primo (x6)



K . Moka bar (x120)



L . Cuillères moka Valmy



M . Vésuve (x12)



N . Olga café



O . Tradition café



P . Tradition dessert

Code	Long cm	Sur.	Prix HT
J . 47 40 095	11,4	6	0,94
K . 47 10 039	11	1	23,12
L . 48 35 990	11	12	0,15
M . 47 35 023	11	1	1,92
N . 47 10 089	11	12	0,30
O . 47 12 007	14,2	12	0,23
P . 47 12 008	17,5	12	0,48



F . Cuillère cocktail Éco



G . Cuillère à glaçons Drakkar



H . Cuillère à glace aluminium

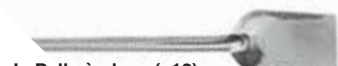

I . Pelle à glace (x12)

Code	Long cm	Sur.	Prix HT
F . 47 10 771	19,5	12	0,51
G . 47 10 472	20	12	2,00
H . 46 10 422	18	12	9,90
I . 47 11 359	10	1	1,93



Q . fourchette tapas



R . Cuillère 3 en 1 Tam Tam



S . Couteau tartineur basic



T . Couteau tartineur soigné

### Mobil Pocket

Inox 18.0 avec boîte de rangement



U . Set de 4 couverts

Code	Long cm	Sur.	Prix HT
Q . 48 35 989	12	12	0,31
R . 47 10 713	12	12	0,37
S . 47 35 820	12	12	0,87
T . 47 10 811	15	12	2,09
U . 47 40 151	18	12	5,33



V . Filla

Code	Long cm	Sur.	Prix HT
S . 47 12 026	11	12	0,88
47 12 024	14	12	1,04
47 12 025	18,5	12	1,25



W . Athéna

Code	Long cm	Sur.	Prix HT
T . 47 12 047	10,5	12	0,73
47 12 046	14	12	1,05
47 12 045	19	12	1,70



X . Nature forgé

Code	Long cm	Sur.	Prix HT
U . 47 12 067	18	12	1,75
47 12 066	13,4	12	1,35



Y . Arès

Code	Long cm	Sur.	Prix HT
V . 47 12 081	10,5	12	0,85
47 12 080	13,8	12	0,90
47 12 079	18,5	12	1,45



Z . 47 12 082 20 (soda) 12 2,15

### Roissy

1,5mm finition brillante, inox 18.0



AA . Fourchette



BB . Cuillère à café



CC . Couteau table

Code	Long cm	Sur.	Prix HT
AA . 47 10 894	16	12	0,49
BB . 47 10 896	12	12	0,41
CC . 47 10 897	16,5	12	0,55
<u>Set de 3 pièces (sous film)</u>			
CC . 47 10 914		1	1,48



A . Fourchette gâteau roissy



C . Fourchette huître Bourget



D . Fourchette huître Valmy



E . Cuillère 3 en 1

Code	Long cm	Sur.	Prix HT
A . 47 10 894	16	12	0,49
C . 47 10 449	12,5	12	0,51
D . 48 35 986	13	12	0,32
E . 47 10 713	12	12	0,37



F . Fourchette escargot Bourget



G . Fourchette escargot Valmy

Code	Long cm	Sur.	Prix HT
F . 47 10 445	13	12	0,51
G . 48 35 987	13,5	12	0,46



H . Couteau à beurre



I . Couteau table croco

Code	Long cm	Sur.	Prix HT
H . 47 10 811	14	12	2,09
I . 47 10 711	17	12	0,52



## Couteaux à crustacés



J .



K .

Désignation	Code	L x Ht cm	Sur.	Prix HT
J . Manche bakélite	47 10 453	15	12	2,05
Manche soft Touch	50 50 844	4,5 x 16	6	8,17

## Pinces à crustacés

Inox 18.0

Inox 18.10



L .



M .

Désignation	Code	Long cm	Sur.	Prix HT
K . Casse noix chromé	47 10 450	15,3	50	5,72
L . Pince crustacés	47 10 452	18	120	19,31

## Pics à crustacés



N .



O .



P .



Q .

Désignation	Code	L x Ht cm	Sur.	Prix HT
M . 12 pics à bigorneaux	47 10 446	7,2	1	2,92
N . 12 tirettes à homard	47 10 457	18,5	1	4,32
O . Curette à crustacés	47 10 451	19,8	12	0,97
Q . Pince à escargot	47 10 448	5 x 14	1	4,12

## Plat à crustacés et support

épaisseur 0,6 mm



R .



S .



T .

Désignation	Code	Φ x Ht cm	Sur.	Prix HT
R . Plat à crustacés	47 10 458	40 x 5	1	22,87
S . Support	47 10 454	25 x 19	1	10,11
T . Gant silicone Noir	50 40 104	11 x 9	6	2,50





# 05

## ACCESSOIRES ET CUISINE



- Moulins à sel et poivre 239 à 241
- Condiments et accessoires 242 à 243
- Accessoires de cuisine 244 à 249
- Plateaux et services 250 à 251
- Accessoires du bar 252 à 257
- Sets de table 258 à 259
- Couteaux professionnels 260 à 261
- Ustensiles de cuisine 262 à 263
- Pâtisserie 264
- Pesage 265
- Ménage 266 à 267

**Hawai**



A. Curry



B. Kaki



C. Paprika

Code	ø x Ht cm	Sur.	Prix HT
A. 79 11 162	6 x 8	4	36,50
B. 79 11 163	6 x 8	4	36,50
C. 79 11 164	6 x 8	4	36,50

**QUALITÉ**

Fabriqué en fonte de haute qualité, robuste et durable, garantie d'une longévité exceptionnelle. Équipé d'un broyeur en céramique de qualité professionnelle, assure une mouture précise et régulière, préservant l'arôme et la saveur de vos épices.



**OGO Professionnel Inox**



D. Sel

Code	ø x Ht cm	Sur.	Prix HT
D. 79 11 136	6 x 23	4	24,95



E. Poivre

Code	ø x Ht cm	Sur.	Prix HT
E. 79 11 135	6 x 23	4	24,50



**ACIER INOXYDABLE**

La fonction et la précision permettent une mouture parfaite des grains. Broyeur en acier carbone. Finition inox soignée.



## Moulins à sel et à poivre

### OGO Professionnel Bois



A . Poivre

B . Sel

C . Poivre

Code	ø x Ht cm	Sur.	Prix HT
A. 79 11 105	6 x 23	6	16,50
B. 79 11 101	5,7 x 15	6	14,95
C. 79 11 115	5,3 x 10	6	10,95

#### GAMME PROFESSIONNELLE

Dont le design, la fonction et la précision en font un choix sûr et moderne.

Le bouton d'ajustement est moleté pour faciliter la prise.

Pour bien reconnaître le moulin, les lettres «S» et «P» sont imprimées sur le dessus du bouton.

Le moulin est également muni d'un ressort pour assurer que la mouture désirée soit constante.



Broyeur en acier carbone (poivre)



Broyeur en acier carbone (sel)

### Moulins recyclés

#### ROBUSTE

Fabriqué en bois de hêtre recyclé, ce moulin à poivre en bois est équipé d'un broyeur en acier carbone de qualité professionnelle. Réglage précis afin d'obtenir une mouture plus ou moins épaissée.



D . Sel 23cm

E . Sel 15cm

F . Poivre 23cm

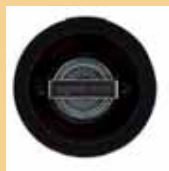

Broyeur en acier carbone poivre



Broyeur en acier inoxydable sel

Code	ø x Ht cm	Sur.	Prix HT
D. 79 11 156	6 x 23	4	24,50
E. 79 11 158	5,5 x 15	6	19,50
F. 79 11 155	6 x 23	6	25,50



### Moulins à manivelle

#### VINTAGE ET INNOVATEUR

Broyeur en acier carbone pour les moulins à poivre. Tranchant et durable. Broyeur en acier inox pour les moulins à sel. Finesse et robustesse.



G . Poivre

H . Sel

Code	ø x Ht cm	Sur.	Prix HT
G . 79 11 145	9,1 x 8,4	6	14,50
H . 79 11 146	9,1 x 8,4	6	14,50

### Leo



I . Sel

Code	ø x Ht cm	Sur.	Prix HT
I . 79 11 124	6 x 31	4	23,95
J . 79 11 170	5,3 x 10,5	6	13,50

### Muscade



J . Muscade

#### PROFESSIONNEL

Moulin à noix de muscade à manivelle en bois de hêtre.

Idéal pour râper très finement la noix de muscade.





## Moulins à poivre & sel



A . Poivre & Sel    B . Poivre & Sel    C . Poivre & Sel

Code	ø x Ht cm	Sur.	Prix HT
A . 50 50 155	6 x 18,5	6	5,18
B . 50 50 156	6 x 18,5	6	5,18
C . 50 50 157	6 x 18,5	6	5,18

### MOULIN COLORÉ

Moulin à sel et poivre doté d'un mécanisme en céramique précis et résistant, avec réglage simple de la mouture. Disponible en coloris céladon, crème et rose clair.



## Moulin électrique

### MOULIN ÉLECTRIQUE

Moulin électrique 2 en 1, équipé de deux zones pour sel et poivre, avec broyeur céramique précis et corps en acier inoxydable 18/0.



D . Poivre & Sel

Code	ø x Ht cm	Sur.	Prix HT
D . 50 50 165	7 x 21,5	6	11,44

## Moulin bois

Moulin en bois de hêtre broyeur céramique.



E . Poivre & Sel

Code	ø x Ht cm	Sur.	Prix HT
E . 50 50 167	6 x 14	6	7,19

## Moulin transparent

Moulin en acrylique transparent broyeur céramique.



F . Poivre & Sel

Code	ø x Ht cm	Sur.	Prix HT
F . 50 50 166	6 x 14	6	4,31

## Classic

Broyeur en céramique.



G . Sel

H . Poivre

Code	ø x Ht cm	Sur.	Prix HT
G . 50 50 082	5,8 x 10	6	6,95
H . 50 50 083	5,8 x 10	6	6,95

## Bois et acrylique

Moulins en plastique transparent et bois naturel.



I . Poivre

J . Sel

Code	ø x Ht cm	Sur.	Prix HT
I . 50 50 064	5,5 x 19,5	6	16,25
J . 50 50 063	5,5 x 19,5	6	14,55

## Copa

Moulins en bambou.



K . Sel

L . Poivre

Code	ø x Ht cm	Sur.	Prix HT
K . 50 50 160	5,5 x 10	6	3,11
L . 50 50 161	5,5 x 10	6	3,11

## Salières & Poivrières



A . Damier  
bouchon plastique



B . Salière verre  
bouchon inox

Code	ø x Ht cm	Sur.	Prix HT
A . 75 13 025	4,5 x 8,5	36	1,62
B . 50 40 027	3,8 x 8	12	1,20

## Saupoudreuses



C . Saupoudreuse



D . Saupoudreuse

Code	Ccl	ø x Ht cm	Sur.	Prix HT
C . 50 40 025	27	7,2 x 11,5	12	2,55
D . 75 31 022	25	8,6 x 9,3	12	5,77



E . Salière  
porcelaine



F . Poivrière  
porcelaine



G . Set sel et poivre  
porcelaine

Code	ø x Ht cm	Sur.	Prix HT
E . 26 91 330	4,1 x 7,2	10	3,55
F . 26 91 331	4,1 x 7,2	10	3,55
G . 29 40 056	4,5 x 7	3	2,95

## Moutardier

À couvercle avec cuillère.



H . Moutardier

Code	ø x Ht cm	Sur.	Prix HT
H . 29 40 057	6,3 x 9	6	3,15



I . Set Eco  
3 pièces



J . Set 2 pièces  
huile et vinaigre

Code	L x l x Ht cm	Sur.	Prix HT
I . 48 35 680	21,8 x 10,6 x 10	24	8,03
J . 48 35 681	11,4 x 5,3 x 21,6	1	8,93



K . Paris  
sel et poivre



L . Ménagère 2  
pièces

Code	ø x Ht cm	Sur.	Prix HT
K . 48 35 682	7,8 x 3,7 x 12,8	12	5,33
L . 48 35 743	13,8 x 7,3 x 22,5	24	10,82

## Authentica



M . Refermable.  
Liège et inox (x2)



N . Bouteille verre  
bec verseur inox

Code	Ccl	ø x Ht cm	Sur.	Prix HT
M . 50 41 048		9,2 x 2,3	8	2,65
N . 75 36 342	27,3	5,8 x 26,1	12	5,61
jauge 25 cl au col de la bouteille				
N . 75 36 343	52,5	6,9 x 31,3	12	6,34
jauge 50 cl au col de la bouteille				

## Optima

Huile



O .

Vinaigre



P .

Verre, bec verseur en  
inox 18/8 joint silicone

Code	L x l x Ht cm	Sur.	Prix HT
O . 75 36 394	7,4 x 5 x 14,3	12	6,64
P . 75 36 395	7,4 x 5 x 14,3	12	6,64

### HUILE & ÉPICES

Ustensiles de cuisine en verre et silicone vert, alliant durabilité, praticité et design soigné pour une utilisation quotidienne optimale.



Q . Pot à épices



R . Bouteille d'huile

Code	Ccl	ø x Ht cm	Sur.	Prix HT
Q . 50 40 259		10,5 x 12,9	6	5,00
R . 50 40 258		9 x 21	6	5,70



S . Bouteille d'huile



T . Pulvérisateur  
d'huile

Code	Ccl	ø x Ht cm	Sur.	Prix HT
S . 50 40 255	50	7,6 x 23,8	6	4,55
T . 50 40 256	25	6 x 18,2	6	4,05



U . Pulvérisateur  
d'huile



V . Set 3 pots avec  
couvercle

Code	Ccl	ø x Ht cm	Sur.	Prix HT
U . 50 39 257	18	7,3 x 22	6	4,55
V . 50 39 075	30	8 x 8,7	6	5,50
W . 50 40 262	75		6	9,40



W . Huilier en  
verre

## Cendriers



A. Rond empilable transparent



B. Rond empilable transparent



D. Inox avec couvercle



E. Inox rond empilable



H. Vide poche carré blanc



C. Rond empilable noir



F. Inox trou large avec couvercle



G. Inox large



I. Cendrier 2 encoches rectangle blanc

Code	ø x Ht cm	Sur.	Prix HT
A. 16 05 105	10,7 x 3,5	48	1,25
B. 75 14 201	8,5 x 3,5	24	2,08
B. 75 41 229	7,2 x 3,8	24	0,99
C. 75 14 203	8,5 x 3,5	24	2,47

Code	ø x Ht cm	Sur.	Prix HT
D. 46 15 191	11 x 4	12	5,95
E. 46 15 313	8 x 3	6	2,59
F. 46 15 192	12,5 x 4,8	12	3,25
G. 46 15 312	15 x 3	6	2,59

Code	ø x Ht cm	Sur.	Prix HT
H. 29 40 064	10 x 10	6	1,95
I. 29 40 063	12 x 9 x 3	12	1,75



J. Ouvre-boîte carbone



K. Ciseaux de cuisine



L. Râpe de cuisine ronde inox



M. Râpe de cuisine rectangulaire inox



N. Toqueur à oeuf inox

Code	L x l x Ht cm	Sur.	Prix HT
J. 50 25 984	13 x 9 x 3	48	0,93
K. 50 15 416	20 x 7,2	24	1,95

Code	L x l x Ht cm	Sur.	Prix HT
L. 50 41 106	11,5 x 11,5 x 24	6	9,58
M. 50 41 105	10,5 x 8 x 26	6	6,55

Code	Ø x Ht cm	Sur.	Prix HT
N. 50 40 452	5 x 25	12	4,55



O. Plateau addition en inox



P. Support magnétique mural



Q. Barre à notes

Code	L x l x Ht cm	Sur.	Prix HT
O. 46 15 202	15 x 11	1	4,76
P. 46 10 424	42 x 5,2 x 1,5	1	8,29
Q. 46 10 028	62,7 x 2,8 x 7	24	19,85



R. Flora bombé



S. Flora droit



T. Vinciana

Désignation	Code	Ø x Ht cm	Sur.	Prix HT
R. Flora bombé	16 13 860	9 x 27,5	6	4,03
S. Flora droit	16 13 862	11,5 x 26,5	6	4,03
U. Vinciana	16 16 139	22,6 x 23	6	10,07

**Deluxe**



**A. Épluche légumes**

**B. Éplucheur**

**C. Économe**

Code	L x l x Ht cm	Sur.	Prix HT
A. 50 40 239	7 x 2 x 16,5	12	9,95
B. 50 40 243	7 x 1,4 x 12	12	3,55
C. 50 40 238	3 x 1,4 x 18,7	12	4,95



**ÉPLUCHAGE FACILE**

Épluche-légumes et économe en plastique noir avec lame inox, conçus pour un épluchage facile et efficace.

**FACILE**

Coupe-pomme 12 tranches en acier inoxydable, offrant précision et robustesse pour un découpage rapide et uniforme.



**D. Coupe pomme**

**E. Presse ail**

Code	L x l x Ht cm	Sur.	Prix HT
D. 50 40 240	17,5 x 5 x 11,7	8	16,25
E. 50 40 235	6 x 3 x 17,2	8	12,45



**F. Mandoline avec poignée**

Code	L x l x Ht cm	Sur.	Prix HT
F. 50 40 246	38,5 x 13 x 6,5	6	8,95



**G. Mandoline sur pied**

Code	L x l x Ht cm	Sur.	Prix HT
G. 50 40 245	37 x 13 x 7,4	6	27,95

**MANDOLINE MULTIFONCTION**

Conçue pour trancher rapidement et uniformément, cette mandoline pliable et antidérapante est équipée d'une lame supplémentaire pour plus de polyvalence.



Deluxe 

Accessoires de cuisine



**OUVRE-BOÎTE MULTIFONCTION**

Outil polyvalent en acier inoxydable, résistant et ergonomique, conçu pour ouvrir facilement boîtes de conserve, bouteilles et pots sans effort.

**A. Ouvre boîte multifonction**

Code	L x l x Ht cm	Sur.	Prix HT
A. 50 40 236	5,3 x 6,5 x 20	8	12,46



**B. Cuillère à glace**

Code	L x l x Ht cm	Sur.	Prix HT
B. 50 40 241	4,5 x 3,4 x 20,5	8	6,75



**C. Casse noix**

Code	L x l x Ht cm	Sur.	Prix HT
C. 50 40 242	4,5 x 2,4 x 18,6	8	8,90



**D. Roulette à pizza**

Code	L x l x Ht cm	Sur.	Prix HT
D. 50 40 244	12,2 x 2,5 x 23,5	8	10,27



**E. Attendrisseur à viande**

Code	L x l x Ht cm	Sur.	Prix HT
E. 50 40 237	5,7 x 5,3 x 17,2	8	14,95

ACCESSOIRES ET CUISINE



A. 500 mL



B. 1000 mL



C. 1500 mL



D. Set de 2 planches à découper en plastique

Code	Ccl	L x l x Ht cm	Sur.	Prix HT
A. 50 40 521	50	10 x 10 x 8,3	6	4,12
B. 50 40 522	100	10 x 10 x 15,7	6	4,95
C. 50 40 523	150	10 x 10 x 23	6	6,62

Code	L x l x Ht cm	Sur.	Prix HT
D. 50 40 578	34,5 x 24,5 x 0,5 29 x 19 x 0,5	6	5,60



E. Set de 4 boîtes empilables avec couvercles



F. Set de 3 bols à mélanger



G. Set de 3 bols de conservation avec couvercles

Code	L x l x Ht cm	Sur.	Prix HT
E. 50 40 577	18,8 x 13,9 x 6,5	6	3,15

Code	ø x Ht cm	Sur.	Prix HT
F. 50 40 468	13,5 x 21,5	6	11,95

Code	ø x Ht cm	Sur.	Prix HT
G. 50 40 575	20,5 x 19,7 16,5 x 7,7 12,8 x 6,2	6	5,60



H. Mini essoreuse à herbe



K. Cloche micro-ondes



I. Essoreuse à salade 2 en 1



J. Essoreuse à salade



L. Passoire

Code	ø x Ht cm	Sur.	Prix HT
H. 50 40 254	13 x 14	6	5,40
I. 50 40 253	24 x 26	4	18,90
J. 50 40 467	25 x 17	6	15,79

Code	ø x Ht cm	Sur.	Prix HT
K. 50 40 397	36 x 9,5	10	1,96
L. 50 40 465	24 x 12	12	3,89





A. Organisateur d'évier



B. Organisateur d'évier 2 en 1



C. Porte-ustensiles

Code	L x l x Ht cm	Sur.	Prix HT
A. 50 40 137	18 x 13 x 12	6	6,60
B. 50 40 138	17 x 12 x 16	6	7,20

Code	L x l x Ht cm	Sur.	Prix HT
C. 50 40 139	18 x 11 x 19	6	8,05



D. Distributeur de savon en verre

Code	Ccl	ø x Ht cm	Sur.	Prix HT
D. 15 10 245	50	10,5 x 15	6	13,55



E. Égouttoir extensible



F. Panier égouttoir extensible

Code	L x l x Ht cm	Sur.	Prix HT
E. 50 40 096	48-34,5 x 19 x 6,5	6	9,00
F. 50 40 099	48-34,5 x 19 x 6,5	12	3,25



G. Égouttoir avec tapis



I. Égouttoir vaisselle + plateau blanc



H. Égouttoir extensible en polypropylène noir

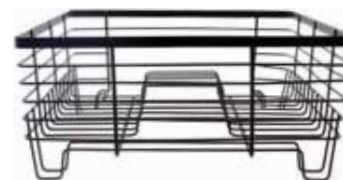

J. Égouttoir vaisselle métal noir

Code	L x l x Ht cm	Sur.	Prix HT
G. 50 40 094	44 x 16 x 3,5	6	6,85
H. 50 40 091	28 x 20 x 9,5	6	10,95

Code	ø x Ht cm	Sur.	Prix HT
I. 63 41 995	34,5 x 42,5 x 9	12	9,95
J. 50 40 090	35,8 x 30,5 x 14,2	4	9,95



## Accessoires de cuisine



**A . Presse citron  
Arc verre**



**B. Presse agrumes**

Code	ø x Ht cm	Sur.	Prix HT
A. 75 16 330	14 x 6,5	12	3,10
B. 50 40 466	15,5 x 10,5	6	4,75



**E.**



**F.**

**Bac à 12 glaçons**

Code	L x l x Ht cm	Sur.	Prix HT
E. 65 15 088	24,5 x 11 x 3,5	12	1,45
F. 50 40 859	30 x 9,4 x 4	12	2,19



**I. Hachoir à ail**



Code	Ø x Ht cm	Sur.	Prix HT
I. 50 40 268	8,9 x 22,5	6	6,65



**C.**



**D.**

**Presse citron**

Code	L x l x Ht cm	Sur.	Prix HT
C. 50 40 265	22,3 x 7,4 x 5	6	4,55
D. 50 40 266	23,5 x 9,3 x 6,5	6	6,65



**G. Mandoline rotative**

Code	L x l x Ht cm	Sur.	Prix HT
G. 50 40 248	24,5 x 11,5 x 27	6	27,95



**H. Mandoline verticale**

Code	L x l x Ht cm	Sur.	Prix HT
H. 50 40 249	26 x 12 x 38	6	18,90



**J. Moulin à coulis**

Code	L x l x Ht cm	Sur.	Prix HT
J. 15 10 329	40 x 21 x 20	8	19,95



**K. Entonnoir confiture**

Code	L x l x Ht cm	Sur.	Prix HT
K. 15 10 332	14 x 21,7 x 8,2	12	1,95



**L. Hachoir à viande manuel**

Code	L x l x Ht cm	Sur.	Prix HT
L. 15 10 328		6	29,95



**M. Entonnoir inox avec filtre**

Code	L x l x Ht cm	Sur.	Prix HT
M. 15 10 341	15 x 13 x 11	10	9,85



A. Kit machine sous vide

Code	L x l x Ht cm	Sur.	Prix HT
A. 15 10 345	37 x 14,6 x 5,5	1	94,95



B. Pompe à main sous vide

Code	ø x Ht cm	Sur.	Prix HT
B. 15 10 346	6 x 19,5	20	26,95
C. 15 10 347	10 x 4	48	8,75



C. Set de 2 couvercles avec valve sous vide



D. Set de 20 sacs zippés avec valve sous vide

Code	L x l cm	Sur.	Prix HT
D. 15 10 385	20 x 30	6	14,85
D. 15 10 386	25 x 35	6	17,45



E. Set de 50 sacs de conservation sous vide gauffrés

Code	L x l cm	Sur.	Prix HT
E. 15 10 387	15 x 20	30	7,45
E. 15 10 388	16 x 24	30	6,05
E. 15 10 389	20 x 30	20	9,95
E. 15 10 390	28 x 40	10	23,65



F. Set de 2 rouleaux de film sous vide gauffré

Code	L x l cm	Sur.	Prix HT
F. 15 10 391	17 x 500	25	10,45
F. 15 10 392	28 x 500	25	15,65



G. Bocal avec couvercle en bois

Code	Ccl	ø x Ht cm	Sur.	Prix HT
G. 15 10 292	58	10 x 12,5	6	4,80
G. 15 10 291	42,5	10 x 9,5	6	4,50
G. 15 10 290	25,5	8,8 x 7,5	6	3,95



H. Déshydrateur électrique

Code	L x l x Ht cm	Sur.	Prix HT
H. 15 10 348	36,5 x 33 x 27,8	1	165,00

Planches à découper en bois d'acacia

novastyl

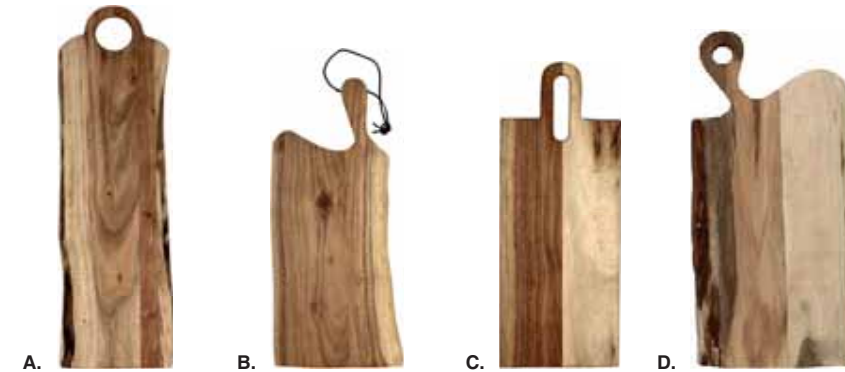

Code	L x l x Ht cm	Sur.	Prix HT
A. 50 40 984	55 x 16 x 1,5	10	9,95
B. 50 40 986	50 x 20 x 1,5	10	9,95

Code	L x l x Ht cm	Sur.	Prix HT
C. 50 40 987	45 x 17 x 1,5	10	8,95
D. 50 40 960	50 x 24 x 1,5	6	10,25



Code	L x l x Ht cm	Sur.	Prix HT
E. 50 40 962	72 x 28 x 1,5	6	16,65
F. 50 40 961	55 x 18 x 1,5	6	8,85

Code	L x l x Ht cm	Sur.	Prix HT
G. 50 40 963	48 x 24 x 1,5	6	9,95
H. 50 40 964	48 x 17 x 1,5	6	7,95



Code	L x l x Ht cm	Sur.	Prix HT
I. 50 40 965	40 x 16,5 x 1,5	6	7,65
J. 50 40 966	48 x 16,5 x 1,5	6	8,95



Code	L x l x Ht cm	Sur.	Prix HT
K. 50 40 973	33 x 12,5 x 1,5	6	2,45
L. 50 40 972	50 x 12,5 x 1,5	6	3,55
M. 50 40 971	80 x 12,5 x 1,5	6	5,45



N . Planche à découper + 3 couteaux



O . Planche à découper décor boeuf

Code	L x l x Ht cm	Sur.	Prix HT
N. 50 40 967	49 x 16 x 2	8	14,45
O. 50 40 974	51 x 36 x 2,2	4	21,95



P . Support à essuie-tout



Q . Planche à pizza

Code	L x l x Ht cm	Sur.	Prix HT
P. 50 40 978	15 x 15 x 33	6	4,75
Q. 50 40 975	40,5 x 30 x 1,5	6	10,85

## Planches de présentation



Planches Agora en bois de hêtre

Code	L x l cm	Sur.	Prix HT
A . 26 32 898	33 x 24	1	37,59
B . 26 32 899	37 x 24	1	51,71



Planches Agora en bois de hêtre

Code	L x l x cm	Sur.	Prix HT
C . 26 32 900	41 x 24	1	61,89
D . 26 32 901	45 x 24	1	69,14



## Dessous plat



H . Dessous plat métal I . Dessous plat Hêtre

Code	ø. x Ht cm	Sur.	Prix HT
H . 65 15 165	20 x 1,5	1	1,45
I . 65 15 167	15 x 0,9	1	3,15

## Planches à découper



F . Planche à découper en polypropylène

Code	L x l cm	Sur.	Prix HT
F . 50 45 400	38 x 23,5	20	9,95
F . 50 45 401	31 x 19,5	20	6,55
F . 50 45 407	25 x 15,5	20	4,55



G . En polyéthylène haute densité

Code	L x l cm	Sur.	Prix HT
G . 46 11 863	50 x 30	6	42,60



F . Set 2 couverts à salade



G . Planche à découper en polypropylène

Code	L x l x Ht cm	Sur.	Prix HT
F . 50 40 968	8 x 8 x 30,5	6	8,50
G . 50 40 969	30,5 x 30,5 x 10	6	17,85

## Plateaux mélamine - Bayadère



Plateau 49 x 30 cm

Code	Couleur	L x l x Ht cm	Sur.	Prix HT
6317280	Vert	49 x 30 x 3	6	6,04
6317281	Rouge	49 x 30 x 3	6	6,04
6317282	Bleu	49 x 30 x 3	6	6,04
6317283	Orange	49 x 30 x 3	6	6,04
6317284	Jaune	49 x 30 x 3	6	6,04



Plateau 35 x 26 cm

Code	Couleur	L x l x Ht cm	Sur.	Prix HT
6317275	Vert	35,6 x 26 x 4	6	4,55
6317276	Rouge	35,6 x 26 x 4	6	4,55
6317277	Bleu	35,6 x 26 x 4	6	4,55
6317278	Orange	35,6 x 26 x 4	6	4,55
6317279	Jaune	35,6 x 26 x 4	6	4,55

## Saucière inox



A . Saucière 14.5cl

Code	Ccl	L x Ht cm	Sur.	Prix HT
A. 46 15 305	14,5	18 x 8,5	6	4,75

## Pots à lait inox



B . Pots à lait

Code	Ccl	Ø x Ht cm	Sur.	Prix HT
B. 46 15 306	35	7 x 8	6	3,65
B. 46 15 307	60	9 x 10,5	6	4,95
B. 46 15 308	90	9 x 12,5	6	6,25
B. 46 15 309	120	10 X 14,5	6	6,75

## Plateaux inox

novastyl



C . Plateaux

Code	L x l cm	Sur.	Prix HT
C. 46 15 326	40 x 31	6	8,95

## Seaux à champagne inox Seaux à glace inox



D . Seau à champagne

Code	Ccl	L x Ht cm	Sur.	Prix HT
D. 46 15 453		22 x 21	6	7,50



Inox 18.10

E .

Code	L x Ht cm	Sur.	Prix HT
E. 47 37 020	11,5 x 11	12	25,48
F. 46 15 347	20 X 21	6	6,95



F . Seau à anses



G . Rafraîchisseur bouteilles

Code	L x Ht cm	Sur.	Prix HT
G. 46 15 348	12 X 20	6	11,65

### UTILE

Permet de garder au frais son champagne, son pétillant ou encore son vin. Ce modèle est muni de poignées pour faciliter le transport. L'acier inoxydable est un matériau durable, résistant à la corrosion et facile à nettoyer.



H . Inox isotherme

Code	Ccl	ø x Ht cm	Sur.	Prix HT
H. 46 15 349	150	15,5 x 15,5	6	18,95

## Vasque à champagne

### PRATIQUE

Grande vasque à champagne permettant de contenir jusqu'à 6 bouteilles. Pratique et élégante avec son socle stable.



Inox 18.0

I . Vasque à champagne

Code	L x Ht cm	Sur.	Prix HT
I. 46 15 260	40 x 22	6	23,95

## Support de table



J . Support seau à champagne

Code	Ccl	L x Ht cm	Sur.	Prix HT
J. 46 10 437	80	22 x 12	1	13,75

## Plateaux inox



A . Plat uni ovale

Code	L x l cm	Sur.	Prix HT
A. 47 10 426	27 x 17	6	7,25
A. 47 10 428	34 x 22	1	9,12
A. 47 10 429	38 x 25	12	11,99
A. 47 10 430	40 x 27	12	13,05
A. 47 10 431	46 x 30	1	14,62
A. 47 10 432	60 x 24	25	19,22



B . Plat rond inox uni

Code	Ø cm	Sur.	Prix HT
B. 47 37 100	30	6	12,48
B. 47 37 101	34	6	14,38



C . Plat ovale

Code	L x l cm	Sur.	Prix HT
C. 47 10 402	30 x 18	1	7,03
C. 47 10 403	35 x 20	1	8,66
C. 47 10 404	40 x 23	1	9,59



D . Plateau rond



F . Plat gratin ovale inox



H . Ramequin inox forme basse



E . Barman rond inox soigné



G . Plat gratin rectangle inox



I . Ramequin inox forme haute

Code	Ø cm	Sur.	Prix HT
D. 46 15 332	40	6	7,65
E. 46 15 200	40	12	17,36

Code	L x l cm	Sur.	Prix HT
F. 47 37 124	Ø 38 x 23	6	20,19
G. 47 37 130	30 x 21	6	18,47
G. 47 37 131	37 x 25	6	21,30

Code	Ccl	Ø x Ht cm	Sur.	Prix HT
H. 47 10 589	4,5	6 x 2,5	50	0,86
I. 47 10 590	7,5	5,7 x 4,2	50	0,97
J. 47 10 591	12	6,6 x 4,7	50	1,09
J. 47 10 592	23,5	6 x 9,5	50	3,25



K . Légumier Régence



L . Saladier «Cul de poule»



M . Passoire



M . Corbeille à pain inox



N . Corbeille à pain inox

Code	Ccl	Ø x Ht cm	Sur.	Prix HT
K. 47 10 415	115	22 x 5,8	1	11,05
L. 46 15 298	500	29 x 14	6	7,95
L. 46 15 297	370	24 x 12	6	6,01
L. 46 15 296	150	19 x 9	6	3,85
L. 46 15 295	75	15 x 8	6	2,45

Code	L x l cm	Sur.	Prix HT
M. 46 15 344	26 X 17	6	8,60

Code	Ø x Ht cm	Sur.	Prix HT
M. 46 15 345	18 X 8	24	3,67
N. 46 15 346	20 x 10,5	24	4,25

**œnologie**



**A . Tire-bouchon Deluxe**

Code	L x l x Ht cm	Sur.	Prix HT
A. 79 11 225	15 x 4 x 11,5	6	31,50

**INCLUS**  
 Livre de recettes  
 Guide mesure  
 Couvercle hermétique



**B . Shaker**

Code	ø. x Ht cm	Sur.	Prix HT
B. 79 11 228	26,5 x 8,5	6	37,50

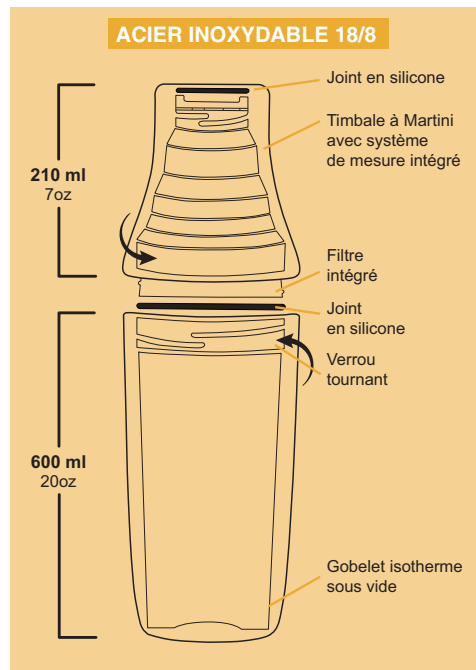

**OUVERTURE FACILE**

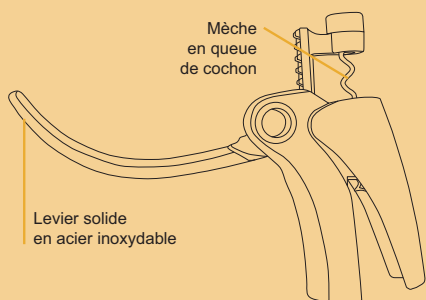

L'acier inoxydable est un matériau durable, résistant à la corrosion et facile à nettoyer. Ce tire-bouchon ajoute une touche de sophistication à chaque dégustation.



**C . Tire-bouchon De Gaulle**

Code	ø. x Ht cm	Sur.	Prix HT
C. 79 11 238	7,3 x 19,2	8	9,50



**D . Tire-bouchon à vis**

Code	ø. x Ht cm	Sur.	Prix HT
D. 79 11 232	20 x 1,5	8	5,95
E. 79 11 230	15 x 15	12	11,50



**E . Tire-bouchon sommelier**

**POLYVALENCE**

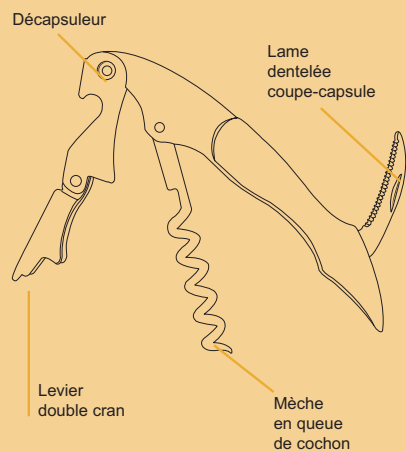

# ÆNOLOGIE

New collection by Ogo



**OGO**  
LIVING



**RAPIDE**

Simple à utiliser, il révèle le bouquet aromatique de vos vins.



**A . Aérateur à vin**

**B . Aérateur bec verseur**

Code	ø. x Ht cm	Sur.	Prix HT
A. 79 11 237	7,5 x 10	6	6,50
B. 79 11 241	3,7 x 16,5	8	5,25



**C . Rafrâchisseur vin**

**PRATIQUE**

Ajuster la température facilement tout en gardant la bouteille fermée. S'adapte à la plupart des bouteilles de vin.



**D . Thermomètre**



Code	L x l x Ht cm	Sur.	Prix HT
C . 79 11 231	15,5 x 3 x 22,5	8	8,95

Code	ø. x Ht cm	Sur.	Prix HT
D . 79 11 236	7,5 x 4	6	9,50



**RAPIDE**

Accessoire indispensable pour servir le vin à la température idéale. Il permet de refroidir rapidement une bouteille sans utiliser de glace, préservant ainsi les arômes et les saveurs. Idéal pour des moments improvisés ou pour garder le vin parfaitement frais tout au long du repas.

**CONSERVATION**

La pompe à vin aide à retirer l'air de la bouteille ou à augmenter la pression pour le champagne, permettant ainsi de prolonger leur durée de conservation et de préserver les saveurs.

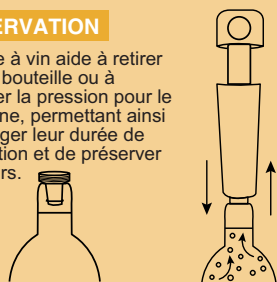

**E . Pompe à vin + bouchons**

Code	ø. x Ht cm	Sur.	Prix HT
E. 79 11 234	4 x 18	8	7,50

**CONSERVATION**

Aussi utiles qu'élégants, ces bouchons hermétiques en acier inoxydable préservent la fraîcheur et les arômes de chacune de vos bouteilles de vin préféré.



A . Bouchon à vin



B . Bouchon à champagne



C . Décapsuleur

Code	L x l x Ht cm	Sur.	Prix HT
A . 79 11 229	2,6 x 2,6 x 7	12	5,50
B . 79 11 239	4 x 4 x 5,6	12	2,95
C . 79 11 233	4,5 x 12 x 16,2	12	4,85



**FACILE**

Des accessoires indispensables pour ôter proprement capsule de bouteille et bouchons de champagne.



D . Coupe-capsule



E . Ouvre-champagne

Code	ø x Ht cm	Sur.	Prix HT
D . 79 11 226	6,2 x 2,1	12	5,75
E . 79 11 227	6,8 x 4,3	12	5,25



F . Limonadier 3 en 1



G . Bec verseur



H . À Levier



I . Limonadier 4 pièces

Code	L x l x Ht cm	Sur.	Prix HT
F . 79 11 242	3,8 x 2,7 x 14	12	5,80
G . 79 11 235	4 x 3 x 10,5	12	6,50

Code	ø. x Ht cm	Sur.	Prix HT
H . 50 41 021	26	12	5,69
I . 50 25 969	rouge ou bleu	12	1,73



J . Verre + bouchon plastique

Code	Ccl	Ø x Ht cm	Sur.	Prix HT
J . 10 29 100	58,5	8 x 16,5	6	12,85

## Sets de table

### Bali

Jonc de mer



Désignation	Code	Ø cm	Sur.	Prix HT
Bali	63 17 045	38	6	5,55

### Tissé

Papier et coton naturel



Couleur	Code	Ø cm	Sur.	Prix HT
Noir	63 17 140	36	144	2,95

### Siam

Jacinthe d'eau



Désignation	Code	L x l cm	Sur.	Prix HT
Siam	63 17 046	45 x 30	12	5,95

### Luna

Jonc de mer



Couleur	Code	Ø cm	Sur.	Prix HT
Bleu	63 17 575	38	6	4,50
Terra	63 17 576	38	6	4,50
Vert	63 17 577	38	6	4,50

### Dune

Cloche en jonc de mer



Couleur	Code	Ø x Ht cm	Sur.	Prix HT
Safran	63 17 598	33 x 17	1	40,83

### Java

Jacinthe d'eau



Désignation	Code	Ø cm	Sur.	Prix HT
Java	63 17 047	38	12	5,95

### Iris

Jonc de mer



Couleur	Code	Ø cm	Sur.	Prix HT
Bleu	63 17 592	38	6	14,50
Safran	63 17 591	38	6	14,50
Vert	63 17 590	38	6	14,50

### Dune

Corbeilles à pain en jonc de mer



Couleur	Code	L x l x Ht cm	Sur.	Prix HT
Bleu	63 17 595	20 x 14 x 7	6	22,50
Safran	63 17 597	18 x 18 x 7	6	22,50
Vert	63 17 596	20 x 20 x 7	6	22,50

novastyl

novastyl

## Tissage

PVC tissé



Désignation	Code	L x l cm	Sur.	Prix HT
Rouge	63 17 105	45 x 30	12	1,55
Bleu	63 17 106	45 x 30	12	1,55
Noir	63 17 107	45 x 30	12	1,55

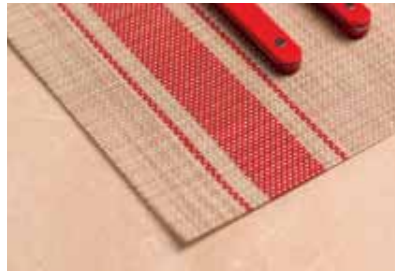

### FINITION

Set de table avec bordures en acier inoxydable 18/10, assurant une excellente tenue sur la table.

PVC tissé

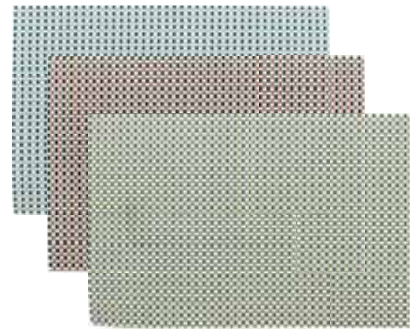

Désignation	Code	L x l cm	Sur.	Prix HT
Bleu	63 17 147	45 x 30	12	1,95
Rouge	63 17 148	45 x 30	12	1,95
Vert	63 17 149	45 x 30	12	1,95

## Vinyl



## Pvc



Désignation	Code	L x l cm	Sur.	Prix HT
Vinyl Noir	63 17 710	45 x 30	12	3,15
PVC Marron	63 17 055	45 x 30	12	2,95

## Leave

PEVA souple



## Bistrot

Toile de jute.



Désignation	Code	L x l cm	Sur.	Prix HT
Leave	63 17 072	43,5 x 28,5	12	1,67
Bistrot	63 17 740	45 x 30	12	2,50



## Jute Naturel



Couleur	Code	L x l cm	Sur.	Prix HT
Blanc	63 17 095	45 x 30	144	1,95
Gris	63 17 096	45 x 30	144	1,95
Marron	63 17 097	45 x 30	144	1,95



## Ica

Plastique effet cuir

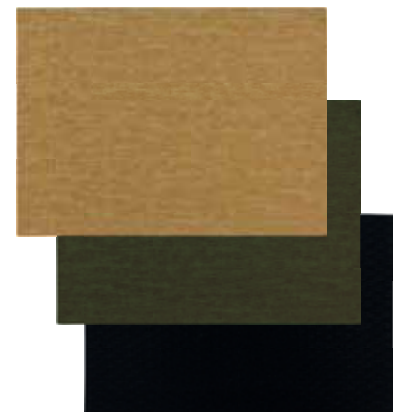

Désignation	Code	L x l cm	Sur.	Prix HT
Marron	63 17 078	43 x 30	12	3,75
Vert	63 17 077	43 x 30	12	3,75
Noir	63 17 076	43 x 30	12	3,75

## Couteaux professionnels

### Origin

#### QUALITÉ

Maître Chef : lame acier inoxydable pleine soie trempé, mitre forgée. Manche Pom, 3 rivets traversants.

**SABATIER**  
TROMPETTE



Code	épaisseur mm	Long lame cm	Sur.	Prix HT
A . 46 10 690	2,5	10	1	11,11
B . 46 10 359	2,5	13	1	15,57
C . 46 10 360	1,8	18	1	16,67
D . 46 10 361	2,5	20	1	17,79
E . 46 10 717	3	17	1	17,17
F . 46 10 340	2,5	18	1	20,13
G . 46 10 355	3	15	1	20,40

Code	épaisseur mm	Long lame cm	Sur.	Prix HT
H . 46 10 701	2,5	30	1	13,56
I . 46 10 356	3	20	1	21,33
J . 46 10 357	3	25	1	24,76
K . 46 10 358	3	30	1	29,97
L . 46 10 362	2,5	25	1	22,29
M . 46 10 691	2	28	1	19,11
N . 46 10 395	1,5	18	1	10,65
O . 46 10 719	4	18	1	19,95

#### QUALITÉ

Couteaux ligne proclassique manche ABS noir avec rivets. Acier trempé lame rivetée transversale, tranchant haute précision.

### Artisan



Code	épaisseur mm	Long lame cm	Sur.	Prix HT
P . 47 10 129	1,2	9	1	2,99
Q . 47 10 130	1,2	11,5	1	1,68
R . 47 35 588	1,2	10	1	3,63
S . 47 10 131	1,2	15	1	4,71
T . 47 40 124	1,2	18	1	5,00
U . 47 10 132	1,8	20	1	5,86

Code	épaisseur mm	Long lame cm	Sur.	Prix HT
V . 47 10 134	1,8	20,5	1	5,26
W . 47 35 589	1,8	20,5	1	5,41
X . 47 10 135	1,8	29	1	5,90
Y . 47 35 590	1,8	18	1	6,38
Z . 47 35 591	1,5	25	1	6,65
AA . 46 10 675	1,8	25	1	8,43
BB . 47 10 136	1,8	29	1	5,59

## Studio



A . Éplucheur



B . Chef Merlon



C . Office



D . 3 rivets grillade



E . Pain studio



F . Office 3 rivets

Code	Long lame cm	Sur.	Prix HT
A . 47 35 017	lame 21	24	1,85
B . 47 35 016	lame 21	24	1,95

Code	Long lame cm	Sur.	Prix HT
C . 47 35 022	19	12	1,04
D . 47 35 094	19	12	0,74

Code	Long lame cm	Sur.	Prix HT
E . 47 10 263	21,5	12	1,04
F . 50 25 987	16	96	0,60

## Flex manche surmoulé

**SABATIER**  
TROMPETTE

### QUALITÉ

Acier X30Cr13, lame flexible. Mitre inox. Manche moulé PP. Insert amovible couleur. 12 spatules incontournables pour les usages en pâtisserie et en grill. Les 5 embouts colorés HACCP fournis permettent de différencier les spatules en fonction de leur usage et ainsi d'éviter les contaminations croisées.



A . Triangle lame large



B . Grillades plate



C . Courbée



D . Large courbée



E . Large courbée



F . Lisse



G . Perforée



H . Large courbée



I . Flexible poisson



J . Spatule droite



K . Spatule droite



L . Spatule droite



M . Spatule droite

Code	L x l x Ht cm	Sur.	Prix HT
A . 46 10 718	13	1	9,60
B . 46 10 399	22 x 15	1	10,78
C . 47 35 265	48 x 25	1	8,03
D . 47 35 269	22	1	10,59

Code	L x l x Ht cm	Sur.	Prix HT
E . 47 35 266	28 x 5	1	12,25
F . 46 10 397	21,5 x 7,5	1	5,75
G . 46 10 398	21,5 x 7,5	1	5,65
H . 47 35 268	34	1	13,53

Code	L x l x Ht cm	Sur.	Prix HT
I . 46 10 396	30 x 8	1	4,80
J . 47 35 261	25	1	7,63
K . 47 35 262	30	1	8,39
L . 47 35 263	35	1	9,36
M . 47 35 264	40	1	9,96

## Pinces

### PRATIQUE

Idéale pour le service des aliments et les barbecues. Résistantes à la chaleur.



A . Pince de service



C . Pince multi-usage inox



D . Pince à glaçons

Code	Longueur cm	Sur.	Prix HT
A . 46 10 510	30	12	9,40

Code	Longueur cm	Sur.	Prix HT
C . 50 40 539	23	12	2,55
D . 46 11 910	19	1	2,78



## Buffet Martin inox 18.10, 3mm



**A . Cuillère à spaghetti**    **B . Cuillère à sauce**    **C . Cuillère à service**    **D . Pince à servir**    **E . Pelle à tarte**    **F . Pelle à frire**    **G . Louche**    **H . Louchette**    **I . Fourchette à salade**    **J . Cuillère à salade**

Code	Long cm	Sur.	Prix HT
A . 47 37 035	30,8	1	12,18
B . 47 37 036	20,7	1	8,33
C . 47 37 037	31,7	1	10,25
C . 47 37 047	30	1	7,69

Code	Long cm	Sur.	Prix HT
D . 47 37 039	10,5	1	7,85
E . 47 37 040	25,9	1	7,00
F . 47 37 041	31,7	1	10,25

Code	Long cm	Sur.	Prix HT
G . 47 37 042	31	1	12,18
H . 47 37 043	26	1	10,35
I . 47 37 045	30	1	7,69
J . 47 37 038	31	1	7,87

## Monobloc 18.0



**K . Araignée 18.10**

**L . Louche 18.10**

**M . Fouet Exoglass**

Code	Ccl	L x Ht cm	Sur.	Prix HT
K . 46 10 384	24 x 45	1	35,65	
K . 46 10 385	66,7 x 28	1	41,80	

Code	Ccl	L x Ht cm	Sur.	Prix HT
L . 46 10 374	7	6,5 x 28	1	9,40
L . 46 10 375	12	8 x 30	1	10,65
L . 46 10 376	20	10 x 38	1	14,75
L . 46 10 377	50	12 x 38	1	15,45
L . 46 10 378	75	14 x 45	1	19,50
L . 46 10 379	100	16 x 56	1	22,75

Code	Long cm	Sur.	Prix HT
M . 46 10 363	25	1	12,45
M . 46 10 364	30	1	14,40

## Monobloc 18.0



**N . Cuillère à servir**

**O . Fourchette**

**P . Louche Valmy**

**Q . Pelle à tarte unie**

**R . Inox**

Code	Long cm	Sur.	Prix HT
N . 47 10 441	24,5	1	1,98
O . 47 10 443	24,5	1	1,98
P . 47 10 455	28	1	2,68

Code	Long cm	Sur.	Prix HT
Q . 47 10 020	25	1	2,05
R . 50 40 541	20	1	1,45
R . 50 40 542	25	12	1,55
R . 50 40 543	30	12	1,95

## Nylon noir



**S . Louche**

**T . Cuillère à sauce**

**U . Écumoire**

**V . Pelle à servir**

Code	Long cm	Sur.	Prix HT
S . 65 15 031	29	1	1,60
T . 65 15 032	29	1	1,60
U . 65 15 033	28	1	1,60
V . 65 15 034	29	1	1,60

Eliott



A . Maryse B . Spatule cuillère C . Spatule

Code	Long cm	Sur.	Prix HT
A . 50 40 186	32	12	3,95
B . 50 40 183	32	12	3,95
C . 50 40 181	32	12	3,95



D . Spatule ajourée E . Cuillère F . Cuillère ajourée

Code	Long cm	Sur.	Prix HT
D . 50 40 182	32	12	3,95
E . 50 40 188	31,5	12	3,95
F . 50 40 185	31,5	12	3,95
G . 50 40 189	27	12	3,95



G . Pinceau H . Louche I . Cuillère à pâtes J . Fouet

Code	Long cm	Sur.	Prix HT
H . 50 40 184	31,5	12	3,95
I . 50 40 180	31,5	12	3,95
J . 50 40 187	25	12	3,95

**MATIÈRE**

Silicone de qualité alimentaire et bois de hêtre.



**Range couverts**

Polypropylène gris, GN 1/1, 4 compartiments.



K . Cuillère L . Spatule biseautée

Code	Long cm	Sur.	Prix HT
K . 60 10 162	35	12	1,00
K . 60 10 163	30	12	0,95
L . 60 10 161	30	12	0,90



M. N. Couverture base GN 1/1

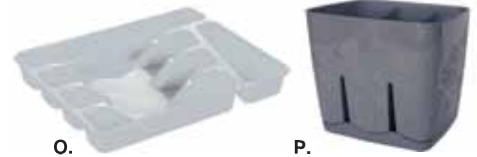

Code	Prof.	L x l cm	Sur.	Prix HT
M . 65 15 455	9	52 x 32	10	10,45
N . 65 14 454		53,7 x 33,2		8,50
O . 63 40 653	13	32,5 x 25	10	2,90
P . 63 40 652	12	11,5 x 13,8	6	3,55

**Casiers de lavage**

**PROFESSIONNEL**

Compatibles et empilables avec la grande majorité des marques de casiers. Existe en 16, 25, 36 et 49 cases.



Code	Casiers 50 x 50 x 10,3	Sur.	Prix HT
<b>16 compartiments</b>			
46 10 250	ø int. max. 11,2	6	29,50
46 10 251	réhausse x ht 4,5 cm	12	12,20
<b>25 compartiments</b>			
46 10 252	ø int. max. 9 cm	1	30,95
46 10 253	réhausse ht 4,5 cm	12	12,95
<b>36 compartiments</b>			
46 10 254	ø int. max. 7,4 cm	6	32,65
46 10 255	réhausse ht 4,5 cm	12	12,95
<b>49 compartiments</b>			
46 10 256	ø int. max. 6 cm	6	34,75
46 10 257	réhausse ht 4,5 cm avec picots	12	13,80
<b>Casier assiettes</b>			
46 10 258		6	24,20
<b>Casier universel</b>			
46 10 264	base open rack	6	24,40
<b>Rehausse sans compartiment</b>			
46 10 266		12	11,25

## Verres doseurs *novastyl*



A . Verre doseur en verre (2 coloris assortis)

Code	Ccl	l x Ht. cm	Sur.	Prix HT
A . 16 05 085	45	8,9 x 14,6	6	2,50

## ARCOROC



B . Verre mesureur Arc  
C . Doseur en verre kitchen lab

Code	Ccl	l x Ht. cm	Sur.	Prix HT
B . 75 16 345	58,5	8 x 16	6	3,85
C . 14 50 124	25	12 x 14	10	4,98
C . 14 50 125	50	11 x 13	6	6,99
C . 14 50 126	75	9 x 10	6	8,13

## PYREX



D . Verre mesureur borosilicate  
E . Broc mesureur borosilicate

Code	Ccl	l x Ht. cm	Sur.	Prix HT
D . 14 50 123	50	10 x 17	6	6,50
E . 14 50 121	50	17 x 12	6	7,41

## Thermomètres de cuisine



I . Thermomètre sonde électronique

Code	Amplitude	EC	Sur.	Prix HT
I . 50 41 043	14-22,5	0,02	6	8,55



F . Verre doseur Précisio

Code	Ccl	ø x Ht cm	Sur.	Prix HT
F . 13 10 155	56	9 x 14,8	12	5,26

## PYREX



G . Broc mesureur avec couvercle

Code	Ccl	ø x Ht cm	Sur.	Prix HT
G . 14 50 127	100	21 x 16	6	11,62



J . Thermomètre plastique pour congélateur

Code	Amplitude	EC	Sur.	Prix HT
J . 46 12 030	-50 +50°C		50	2,95



K . Jatte Classic

Code	Ccl	L x l x Ht. cm	Sur.	Prix HT
K . 14 50 119	300	24 x 13	6	9,37
K . 14 50 118	200	21 x 11	6	7,35
K . 14 50 117	100	17 x 10	12	5,30
K . 14 50 116	50	14 x 8	12	3,76



### PRATIQUE

Idéal pour la réalisation de crème brûlée.



L . Chalumeau culinaire

Code	ø. x Ht cm	Sur.	Prix HT
L . 47 10 880	10 x 19	1	24,33



M . Cuillère Électronique

Code	Long cm	EC	Sur.	Prix HT
M . 79 15 050	23	0,02	12	12,85

### ASTUCIEUX

Cette cuillère à mesurer est équipée d'un mini système de pesage pour cuisiner avec précision. Portée 300 g, graduation 0,1 g. Affichage LCD. ABS et acier inoxydable. Arrêt automatique.



**Balances électroniques** ■ Garantie 5 ans



**A . Compact noir**

Code	Grad. gr	EC	Sur.	Prix HT
A . 08 61 515	1	0,06	6	18,32

Portée 5 kg. Forme compacte et extra plate 20 x 15 x 1,3 cm. Affichage LCD 12 mm. Technologie Sensor Touch brevetée. Fonctionne avec 1 pile lithium CR 2430 fournie.



**B . Compact gris**

Code	Grad. gr	EC	Sur.	Prix HT
B . 08 61 516	1	0,06	6	18,32

Portée 5 kg. Forme compacte et extra plate 20 x 15 x 1,3 cm. Affichage LCD 12 mm. Technologie Sensor Touch brevetée. Fonctionne avec 1 pile lithium CR 2430 fournie.



**C . Page Profi 100**

Code	Grad. gr	EC	Sur.	Prix HT
C . 08 61 506	1	0,11	4	31,96

Portée 15 kg. Plateau de pesée extra large 24 x 17,5 cm. Affichage LED Blanc 22 mm. Technologie Sensor Touch brevetée. Fonctionne avec 3 piles 1,5 V AAA fournies.



**D . Comfort 400**

Code	Grad. gr	EC	Sur.	Prix HT
D . 08 61 505	1	0,11	4	23,96

Portée 10 kg. Grand plateau en verre 22 x 22 x 1,8 cm. Technologie Sensor Touch brevetée. Affichage de l'heure en mode veille.



**E . Page Profi 200  
inox**

Code	Grad. gr	EC	Sur.	Prix HT
E . 08 61 509	1	0,11	4	38,36

Portée 15 kg. Large surface 24 x 17,5 cm. En acier inoxydable haute qualité. Technologie Sensor Touch. Revêtement anti-traces de doigts. Fonctionne avec 3 piles 1,5 V fournies.



**F . Page Profi 300**

Code	Grad. gr	EC	Sur.	Prix HT
F . 08 61 507	1	0,11	4	35,96

Portée 20 kg. Grand plateau 27 x 20 cm. Très grand affichage LCD 25 mm. Technologie Sensor Touch brevetée. Fonction HOLD : le poids reste affiché même après la pesée. Fonctionne avec 3 piles 1,5 V AAA fournies.



**G . Balance électronique  
inox**

Code	Grad. gr	EC	Sur.	Prix HT
G . 62 11 016	1	0,13	6	9,90

Portée 5 kg. Surface 18 x 14 cm. En acier inoxydable haute qualité. Écran LCD. Fonctionne avec 2 piles AAA fournies.

**Pèse-personnes**

■ Garantie 5 ans



**H . Balance électronique  
inox**

Code	Grad. gr	Sur.	Prix HT
H . 06 61 098	1000	4	19,96

Portée 130 kg. Châssis en acier. Surface antidérapante avec revêtement en caoutchouc.

## Balais et accessoires

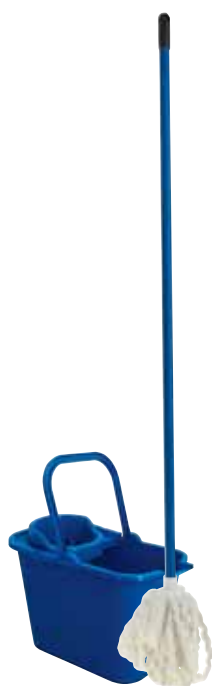

A . Ens. seau 12 L + essoreur rectangle + manche 1,20 m av. mop

Code	Sur.	Prix HT
A . 63 40 646	40	8,85
B . 65 15 061	30	6,55



D . Manche seul balai bois vis Fr

C . Tête seule balai coco (s'adapte sur pas de vis Fr)

B . Ens. balai coco + manche bois vis Fr

Code	Long cm	Sur.	Prix HT
C . 65 15 183	28	12	3,30
D . 65 15 184	120	1	3,25
E . 65 15 062		12	6,35



F . Tête seule balai brosse (s'adapte sur pas de vis Fr)

E . Ens. balai lave-pont + manche bois vis Fr



G . Ens. balai nylon + manche plas.

Code	Long cm	Sur.	Prix HT
F . 65 15 189	22	12	3,70
G . 63 40 670	120	60	3,45
H . 63 40 666		12	3,30



H . Pelle + balayette gris foncé



I . Tête seule balai nylon (sur manche 6515184)

Code	Long cm	Sur.	Prix HT
I . 65 15 187	30	12	3,30
J . 65 15 038	30	12	2,10



J . Tête seule balai nylon frontier



K . Raclette métallique

Code	Long cm	Sur.	Prix HT
K . 65 15 322	35	10	2,30
L . 65 15 316		25	1,99
M . 65 15 128	6,5	1	1,25



L . Tête mop seule coton embout vis française



M . Brosse vaisselle



N . Serpillère coton

Code	L x l cm	Sur.	Prix HT
N . 65 15 181	50 x 100	30	3,45
O . 65 15 318	60 x 50	30	2,35



O . Serpillère coton



P . Essoreur seul



Q . Seau mop rectangle 12 L

Code	L x l x Ht cm	Sur.	Prix HT
P . 63 40 645	13,5 x 16 x 12	15	1,65
Q . 63 40 644	21 x 38 x 25,5	15	4,60
R . 65 15 008	31 x 13	1	1,75

R . Essoreur seul



S . Seau rond à bec 12 L

Code	Litres	Ø x Ht cm	Sur.	Prix HT
S . 65 15 105	12	27,5 x 26,5	10	4,25
T . 63 40 642	4	26 x 12	1	2,55



T . Bassine ronde



U .



V .

Support + brosse WC

Code	Sur.	Prix HT
U . 63 40 673	20	2,10
V . 63 40 665	20	2,10

## Poubelles &amp; corbeilles



A . Oscar



B . Klip



C . Corbeille à papier



D . Seau + couvercle



E . Tapis caoutchouc

Code	Litres	ø x Ht cm	Sur.	Prix HT
A . 63 40 660	7	20 x 29	8	5,50
B . 63 40 658	26	27 x 34 x 51	6	14,55
B . 63 40 657	12	22 x 26 x 40	8	9,05

Code	Litres	L x l x Ht cm	Sur.	Prix HT
C . 63 40 659		28 x 28	15	2,90
D . 63 40 662	16	30 x 30	10	5,65

Code	L x l cm	Sur.	Prix HT
E . 65 15 093	37 x 51	10	7,95

## Cintres &amp; pinces



F . Anneau antivolt pour cintres



G . Cintre plastique antivolt



H . Cintre plastique jupe antivolt



I . Cintres plastique noir pince jupe



J . Cintre plastique noir avec tête en métal

Code	Long cm	Sur.	Prix HT
F . 65 15 112		1	0,40
G . 65 15 111	42	250	0,85

Code	Long cm	Sur.	Prix HT
H . 65 15 205	42	150	1,60
I . 65 15 090	36	5	1,05

Code	Long cm	Sur.	Prix HT
J . 65 15 204	40	1	0,80

## Étendage



M . Séchoir tour Rennes (3 niveaux)

Code	L x l x Ht cm	ECO	Sur.	Prix HT
M . 65 15 326	74 x 69 x 126	0,22	4	36,95



K . Cintre en bois de hêtre vernis

Code	Long cm	Sur.	Prix HT
K . 65 15 438	44	5	1,65



L . Sachet 24 pinces à linges plastique multicolores

Code	Sur.	Prix HT
L . 63 41 989	1	2,65



N . Séchoir linge Vulcano

Code	L x l x Ht cm	ECO	Sur.	Prix HT
N . 65 15 324	180 x 55 x 100	0,22	6	28,05



O . Table à repasser Lyra (ajustable de 76 à 92 cm)

Code	L x l x Ht cm	ECO	Sur.	Prix HT
O . 65 15 443	110 x 34 x 92	0,22	4	60,20



### Ensemble Montauk

L'ensemble à manger Montauk séduit par son design moderne, sa forme conviviale et son élégante teinte Brique.



### Fauteuil de bar Amalfi

Le fauteuil de bar Amalfi allie finesse moderne et solidité, idéal pour des espaces élégants.



### Fauteuil de table Eros

Le fauteuil de table Eros associe un tissu doux à une structure en métal doré, pour un rendu élégant et équilibré.



### Fauteuil Hella

Le fauteuil Hella combine une assise confortable en tissu bouclette et une structure en bois de frêne.



06

## MOBILIER



Fauteuils de table extérieurs	270
Mobilier extérieur	271 à 273
Fauteuils de table intérieurs	274 à 276
Fauteuils Lounge	277 à 279

## Amalfi & Capri

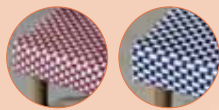

Disponible en  
Rouge et Bleu



Ht. 46 cm

Fauteuil de table Amalfi



Ht. 46 cm

Fauteuil de table Capri



**REVÊTEMENT**

Textilène tressé

**STRUCTURE**

Aluminium +  
Rotin synthétique

Désignation	Coloris	Code	L x l x Ht cm	SUR.	Prix HT
Amalfi	Naturel	72 24 388	57 x 57 x 82	2	141,25
	Rouge	72 24 384	57 x 57 x 82	2	141,25
	Bleu	72 24 386	57 x 57 x 82	2	141,25
Capri	Naturel	72 24 380	49 x 42 x 93	2	166,25



Ht. 46 cm

Chaise Amalfi beige

Désignation	Coloris	Code	L x l x Ht cm	SUR.	Prix HT
Chaise Amalfi	Beige	72 24 402	50 x 57 x 85	2	128,75



**REVÊTEMENT**

Textilène tressé

**STRUCTURE**

Aluminium +  
Rotin synthétique



Désignation	Coloris	Code	L x l x Ht cm	SUR.	Prix HT
Fauteuil bar Amalfi	Naturel	72 24 394	41 x 57 x 112	2	164,58
	Rouge	72 24 390	41 x 57 x 112	2	164,58
	Bleu	72 24 392	41 x 57 x 112	2	164,58
Tabouret bar Amalfi	Naturel	72 24 382	35 x 35 x 74	2	82,92

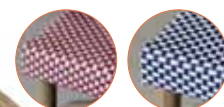

Disponible en  
Rouge et Bleu



Ht. 75 cm

Fauteuil de bar Amalfi



Ht. 74 cm

Tabouret de bar Amalfi

## Napoli



Disponible en Vert, Blanc & Taupe

Ht. 73 cm

120 cm

**STRUCTURE**  
Aluminium

**REVÊTEMENT**  
Textilène

**Chaise longue Napoli**

Désignation	Coloris	Code	L x l x Ht cm	SUR.	Prix HT
Chaise longue Napoli	Corail	72 28 076	193 x 62 x 34	2	208,29
	Vert	72 28 078	193 x 62 x 34	2	208,29
	Blanc	72 28 080	193 x 62 x 34	2	208,29
	Taupe	72 28 082	193 x 62 x 34	2	208,29



## Patio

Disponible en Brique



Canapé : 102 x 53 x Ht. 79 cm  
Fauteuil : 55 x 53 x Ht. 79 cm  
Table : 70 x 52,5 x Ht. 39 cm

**Salon de jardin Patio**

Désignation	Coloris	Code	SUR.	Prix HT
Salon Patio	Vert	72 28 135	1	495,83
	Brique	72 28 136	1	495,83



Chaise : 46 x 52 x Ht. 83 cm  
Table : 141,5 x 70 x Ht. 74,5 cm

**Ensemble de jardin Patio**

Désignation	Coloris	Code	SUR.	Prix HT
Ensemble Patio	Vert	72 28 143	1	665,83



# Calypso

Disponible en  
Brique & Ocre



Canapé : 131 x 74 x Ht. 74 cm  
Fauteuil : 79 x 71 x Ht. 72 cm  
Table : 80 x 45 x Ht. 45 cm

Salon de jardin Calypso

Désignation	Coloris	Code	SUR.	Prix HT
Salon Calypso	Vert	72 28 140	1	579,17
	Brique	72 28 141	1	579,17
	Ocre	72 28 142	1	579,17



ASSISE & DOSSIER  
Polypropylène

TABLE  
Métal

PIEDS  
Métal



TABLE  
Métal



Disponible en  
Vert & Ocre

Ensemble de jardin Calypso

Désignation	Coloris	Code	SUR.	Prix HT
Ensemble Calypso	Vert	72 26 360	1	582,50
	Brique	72 26 361	1	582,50
	Ocre	72 26 362	1	582,50



Disponible en  
Vert & Brique



Ht. 46 cm

Fauteuil de table Calypso

Table Bel Air



Désignation	Coloris	Code	L x l x Ht cm	SUR.	Prix HT
Fauteuil Calypso	Vert	72 26 346	65 x 58 x 78	4	83,13
	Brique	72 26 348	65 x 58 x 78	4	83,13
	Ocre	72 26 350	65 x 58 x 78	4	83,13
Table Bel Air	Vert	72 26 310	80 x 80 x 72,5	1	249,17
	Brique	72 26 311	80 x 80 x 72,5	1	249,17
	Ocre	72 26 312	80 x 80 x 72,5	1	249,17

# Montauk

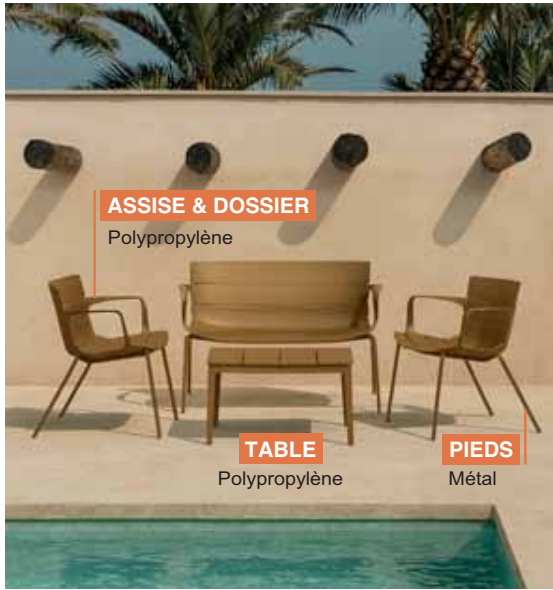

**ASSISE & DOSSIER**

Polypropylène

**TABLE**

Polypropylène

**PIEDS**

Métal



Disponible en  
Brique & Ocre

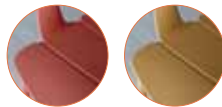

Disponible en  
Vert & Brique



Canapé : 110 x 60 x Ht. 70,5 cm  
Fauteuil : 60 x 60 x Ht. 70,5 cm  
Table : 70 x 53 x Ht. 38,5 cm

**Salon de jardin Montauk**

Désignation	Coloris	Code	L x l x Ht cm	SUR.	Prix HT
Salon Montauk	Vert	72 28 137	?	1	579,17
	Brique	72 28 138	?	1	579,17
	Ocre	72 28 139	?	1	579,17



**Ensemble de jardin Montauk**

Désignation	Coloris	Code	SUR.	Prix HT
Ensemble Montauk	Vert	72 26 355	1	582,50
	Brique	72 26 356	1	582,50
	Ocre	72 26 357	1	582,50



Ht. 45 cm

**Fauteuil de table Montauk**

Désignation	Coloris	Code	L x l x Ht cm	SUR.	Prix HT
Fauteuil Montauk	Vert	72 26 340	55,5 x 57,5 x 80	4	83,13
	Brique	72 26 342	55,5 x 57,5 x 80	4	83,13
	Ocre	72 26 344	55,5 x 57,5 x 80	4	83,13

Gina

**STRUCTURE**

Métal noir peint par poudrage



Ht. 49 cm

Chaise Gina Moka

Chaise Gina Beige

Désignation	Coloris	Code	L x l x Ht cm	SUR.	Prix HT
Chaise Gina	Moka	72 24 490	50 x 49,5 x 79	2	149,58
	Beige	72 24 492	50 x 49,5 x 79	2	149,58



**REVÊTEMENT**

Polyester Tweed texturé



Fauteuil Lounge Gina Beige

Chaise Bar Gina Beige

Désignation	Coloris	Code	L x l x Ht cm	SUR.	Prix HT
Fauteuil Lounge Gina	Beige	72 24 496	62 x 75,5 x 68	1	245,83
Chaise Bar Gina	Beige	72 24 494	47,5 x 58,5 x 95,5	2	164,58

Ginette



**REVÊTEMENT**

Polyester Tweed texturé



Ht. 48,5 cm

Fauteuil de table Ginette



Désignation	Coloris	Code	L x l x Ht cm	SUR.	Prix HT
Ginette	Tabac	72 24 480	58 x 63,5 x 84	1	165,83

## Eros



Disponible en  
Brique



Fauteuil de table Eros

Désignation	Coloris	Code	L x l x Ht cm	SUR.	Prix HT
Fauteuil Eros	Latte	72 24 435	57,7 x 56,3 x 84,5	2	142,25
	Brique	72 24 437	57,7 x 56,3 x 84,5	2	141,25
	Ecrû	72 24 439	57,7 x 56,3 x 84,5	2	141,25

## Maia

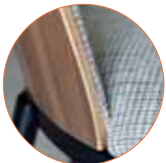

**DOSSIER**

Bois effet noyer



Chaise Maia

Désignation	Coloris	Code	L x l x Ht cm	SUR.	Prix HT
Chaise Maia	Latte	72 24 442	50 x 58 x 83	2	166,25

## Gaston



Chaise Gaston Écrû

Chaise Gaston Châtaigne

Désignation	Coloris	Code	L x l x Ht cm	SUR.	Prix HT
Chaise Gaston	Écrû	72 24 445	42,5 x 56,5 x 78,5	2	125,00
	Châtaigne	72 24 447	42,5 x 56,5 x 78,5	2	125,00

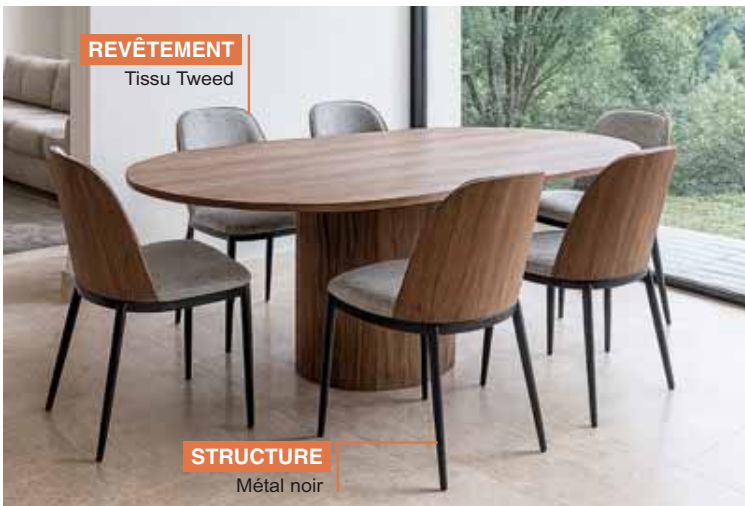

**REVÊTEMENT**

Tissu Tweed

**STRUCTURE**

Métal noir



**ASSISE**

Tissu bouclette Écrû

**ASSISE**

Tweed Marron

## Chaises de table

### Nosara



Disponible en  
finition naturelle



Disponible en  
finition noire



Chaise Nosara

Ht. 46 cm



Chaise de bar Nosara

Ht. 72 cm

Désignation	Coloris	Code	L x l x Ht cm	SUR.	Prix HT
Chaise Nosara	Naturel	72 24 334	47 x 53 x 82	2	103,75
Chaise Nosara	Noir	72 24 336	47 x 53 x 82	2	103,75
Chaise bar Nosara	Naturel	72 24 330	45 x 50 x 99	2	124,58
Chaise bar Nosara	Noir	72 24 332	45 x 50 x 99	2	124,58



ASSISE + DOSSIER  
Finition noyer

### Gaspard



Chaise Gaspard Marron



Chaise Gaspard Noire

Ht. 45 cm

Désignation	Coloris	Code	L x l x Ht cm	SUR.	Prix HT
Gaspard	Marron	72 24 340	49 x 57,5 x 82,5	2	141,25
Gaspard	Noir	72 24 342	49 x 57,5 x 82,5	2	141,25

### Riva



Chaise Riva Terracotta



Chaise Riva Écru

Ht. 46,5 cm



Désignation	Coloris	Code	L x l x Ht cm	SUR.	Prix HT
Chaise Riva	Terracotta	72 24 344	51 x 52 x 73,5	2	124,58
Chaise Riva	Écru	72 24 346	51 x 52 x 73,5	2	124,58



DOSSIER  
Finition noyer

ASSISE  
Velours  
côtelé

**Funky**



Fauteuil Funky Safran



Fauteuil Funky Beige



Fauteuil Funky Terracotta

Ht. 42 cm

Code	L x l x Ht cm	SUR.	Prix HT
72 24 485	62 x 74 x 75	1	249,17

Code	L x l x Ht cm	SUR.	Prix HT
72 24 486	62 x 74 x 75	1	249,17

Code	L x l x Ht cm	SUR.	Prix HT
72 24 487	62 x 74 x 75	1	249,17



Fauteuil Funky Vert



Fauteuil Funky Rose

Désignation	Coloris	Code	L x l x Ht cm	SUR.	Prix HT
Fauteuil Funky	Vert	72 24 488	62 x 74 x 75	1	249,17
	Rose	72 24 489	62 x 74 x 75	1	249,17



**REVÊTEMENT**  
Velours côtelé

**PIED**  
Métal noir



Sixties



Fauteuil pivotant Sixties

Désignation	Coloris	Code	L x l x Ht cm	SUR.	Prix HT
Fauteuil Sixties	Ocre	72 24 369	77 x 74 x 80	1	540,83

Ulysse



Fauteuil Ulysse



Pouf Ulysse



Désignation	Coloris	Code	L x l x Ht cm	SUR.	Prix HT
Fauteuil Ulysse	Beige	72 24 370	72 x 75 x 73,5	1	415,83
Pouf Ulysse	Beige	72 24 371	64 x 44 x 45	1	165,83

Hella



Fauteuil Hella



Désignation	Coloris	Code	L x l x Ht cm	SUR.	Prix HT
Fauteuil Hella	Blanc	72 24 424	70 x 72 x 72	1	632,50

## Yack



Ht. 47 cm

Fauteuil Yack Beige



Fauteuil Yack Cappuccino



**REVÊTEMENT**

Tissu effet mouton

**STRUCTURE**

Bois de frêne

Désignation	Coloris	Code	L x l x Ht cm	SUR. Prix HT
Fauteuil Yack	Beige	72 24 420	71 x 79 x 77	1 832,50
Fauteuil Yack	Cappuccino	72 24 421	71 x 79 x 77	1 832,50

## Artic

Disponible  
en Bleu



Ht. 42 cm

Fauteuil Artic



**REVÊTEMENT**

Tissu effet  
fourrure

**PIEDS**

Bois noir

Désignation	Coloris	Code	L x l x Ht cm	SUR. Prix HT
Fauteuil Artic	Blanc	72 24 422	76 x 81 x 77	1 649,17
Fauteuil Artic	Bleu	72 24 423	76 x 81 x 77	1 649,17

A	
1920 America	37
1960 Roma	21
Abondance carafe	78
Academia Luigi Bor	19
Accessoires Silicone	216
Achille steak	235
Acier carbone plat	199
Acrylique moulines	241
Adam	78
Addition plateau	243
Adonis	226
Adonis Icy givré	226
Adventure	53
Aérateur verseur	256
Aere gobelet	71
Agora planches	251
Agora saladiers	117
Airfryer plats	205
Alaska porcelaine	137
Alaska tasses	168
Albus	115
Alhambra	114
Alkemist	26
Allegra	46
Allegra Focus	46
Alu cuisson	191
Alu forgé poêles	190
Alu Pro Ménastyl	186
Amalfi fauteuil	270
Amande Riga	167
Amandine Colorama	199
Amandine moules	200
Amatxi	135
Ambassador porcelaine	138
Ambassador tasses	168
Ambassador vap	46
Amber vap	44
Ambition couverts	227
Ambre grès	131
Amélia Vap	34
America 1920	37
Amerika théière	162
Amestista double paroi	167
Amestista Chopes	68
Amovable Easynox	183
Amovibles Ménastyl	184
Amsterdam chope	72
Amsterdam couverts	222
Anchor Onis	53
Angélique cadre	199
Animaux de la forêt	127
Anse carafes	78
Anti vent cendrier	243
Antidérapant	154
Antivol cintres	266
Aqua	128
Aquitania Nova	148
Araignées inox	262
Aras chopes	160
Arc Broc	77
Arcade	64
Arcade Ambition	227
Arcadie	64
Arcole Bol	147
Arcopal	149
Arcoroc trempé	64
Arcoroc Vap	34
Arcuisine plats	204
Arès	236
Arès couverts	231
Arès Vintage couverts	231
Ariane couverts	229
Aristo Carré vap	52
Aroma tasses	167
Aronal	98
Arosa chope apéro	71
Artisan	260
Artisan couteaux	235
Assiette mélamine	154
Assiette salade	156
Astral vap	13
Atelier carafes	76
Athens couverts	229
Atome	122
Attendrisseur viande	245
Aura Bonna	121
Aurum chopes	36
Aurum vap	36
Authentica bouteilles	74
Autonomy assiettes	148
Autonomy chope	148

## B

Bac glaçons	248
Bach chopes	20
Bach cocktail	20
Bach vap Luigi	20
Bacs Gastronorme	202
Bacs polypropylène	203
Baguette Améfa	231
Baguette OGO	234
Bake & Enjoy	207

Balais	266
Balances électroniques	265
Ballon Arcoroc	32
Ballon banquet	47
Ballon Cabernet	11
Bamboo Tiki	60
Bambou couteau steak	235
Bambou couverts	226
Banquet vap Ballon	47
Bar OGO	254
Baril gobelet	161
Barman plateau	253
Barracuda	23
Barre aimantée	243
Barre notes	243
Barshine	39
Bartender flûtes	38
Bartender mules	60
Barware Chopes	20
Basic Mug	167
Bassine confiture	196
Batch cooking	209
Bayadere plateaux	251
Bec verseur OGO	257
Becs verseur Optima	242
Beige Octave	198
Beige Urus	90
Bel Air table	272
Belek	49
Belfesta (ex Pure)	15
Beurrier verre	157
Bière chopes	54
Bière chopes anses	55
Bière verres à pied	55
Bistro Martini	57
Bistro vap	47
Bistrot Bormioli	77
Bistrot Le Parfait	213
Black Evolution	150
Blanc marmite	197
Blender Pro	218
Bleu brush	149
Bleu Faustine	132
Bleu Kuwae	154
Bleu Urus	90
Bloom Bonna	120
Blue Jean's Opal	149
Bocal bois	249
Bocaux	213
Bocaux Bistrot	213
Bocaux Le Parfait	214
Bocaux LPS	214
Bock à bière	55
Bock Opal	151
Bocks thé verre	167
Bodega Bonita	71
Bodéga chopes	67
Bois bocal	249
Bois ménagères	227
Bois moulines	240
Boite de 4 verres	69
Boîtes avec couvercles	211
Boîtes borosilicate	211
Boites Food box	209
Boites sous vides	218
Bol Opal	151
Bol Oslo	147
Bol pasta	144
Bola tasses	168
Bols à pâtes	144
Bols grès	167
Bols mise en bouche	156
Bols Opal	151
Bols pasta porcelaine	143
Bols plastique	246
Bongo steak	231
Bonita	48
Bonna	114
Bonna Albus	115
Bonna grès vitrifié	120
Bonna pizzas	114
Bonna plats	156
Boral OGO	99
Bordeaux Opal	149
Bormioli Luigi	18
Borosilicate	208
Boston shots	160
Botanic	125
Botanica carafe	78
Bouchon optima	74
Bouchons vin	257
Bouilloire électrique	219
Boule pichets	77
Boule thé	166
Bouteilles Authentica	242
Bouteilles Elixir	74
Bouteilles fraîcheur	215
Bouteilles Swing Top Lps	215
Brasseur	49
Brio moulines	241
Brio vap flûtes	57
Britannia Bock	55
Brixton chopes	63
Broadway colors	31
Broadway vap	31
Broc Arc	77

Broc Bistrot	77
Broc mesure	264
Brocs pichets	77
Brosse balai	266
Brosse vaisselle	266
Brosse WC	266
Brush Opal	149
Buffet Martin	262
Byzance porcelaine	126

## C

C & S flûtes	30
Cabana couverts	232
Cabernet Ballon	11
Cabernet cocktail	56
Cabernet flûtes	59
Cabernet Tulip	11
Cabernet Vin Jeunes	10
Cadres acier	199
Café Gourmand Bonna	120
Cafeino Duos	167
Cafétéria porcelaine	147
Cafetière électrique	219
Cafetières borosilicate	166
Caffeino Bormioli	160
Cake moules acier	200
Cake O Cuisine	204
Cake Octave	198
Caldera	45
Calice tasses	137
Calices Timeless	40
Calypso salon	272
Calypso sets salon	272
Campagnard bois couteau	235
Campagne bol	156
Campus Arcoroc	65
Canisse couverts	226
Cannelle	190
Cannelle Ménastyl	190
Capri fauteuil	270
Capri vap	44
Capria	134
Capsules Familia Wiss	215
Capsules pots confiture	215
Caracas feston	151
Caractère couverts	234
Carafe Exclusiva	38
Carafe infuser	164
Carafe Timeless	41
Carafes	74
Carafes Atelier	76
Carafes décanter	78
Carafes Misure	76
Carafons vin Arc	75
Caravelle	72
Carbone porcelaine	140
Carlton	228
Carpaccio porcelaine	146
Carré Alaska porcelaine	137
Carré Aristo vap	52
Carré carafes Arc	75
Carré coupelles	139
Carré Opal restaurant	148
Carré porcelaine	139
Carré saladiers Duralux	157
Carré saladiers porcelaine	139
Carré tasses empilables	139
Casablanca chopes	61
Casablanca Mise en bouche	160
Casiers lavage	263
Casse noix	245
Casse patte crustacés	237
Casseroles inox	182
Casseroles inox	185
Casseroles inox Pro	180
Cassis saladiers	209
Céladon boîtes	210
Céladon cuisson	188
Celebrazione	37
Cendrier inox	243
Cendriers	243
Cendriers empilables	243
Céramique OGO	99
Cerf	127
Cerise casseroles	191
Cerise cuisson	191
Cervoise Arc	55
Ceylan verre thé	167
Chafing Dish	218
Chaise Amalfi	270
Chaise Bar	274
Chaise longue	271
Chaises	276
Chalumeau culinaire	264
Champagne calice	19
Chardonnay Supremo	21
Charlotte grès	133
Charnière moules	199
Chef & Sommelier gobelets	8
Chef couteaux	260
Chef et Sommelier	4
Chef Saladiers	153
Cherry brush	149
Chianti Supremo	21

Chicago	61
Chiller	57
Chinoise cuiller	156
Chiquito trempé	158
Chopes bière	55
Chopes facettes	68
Chuletero steak	234
Cylindral double paroi	167
Cintres	266
Ciseaux	243
City carafe	73
Classic cocottes	205
Classic filet or porcelaine	140
Classic jattes	264
Classic Trudeau	241
Classic verre mesure	264
Classico vap Zwiesel	17
Clémentine	211
Cloche micro-ondes	246
Club Novastyl	71
Cocktail America	37
Cocktail Cabernet	57
Cocktail calice	37
Cocktail cuillers	236
Cocktail Mondial	14
Cocktails	57
Coco balai	266
Cocoon saladiers	153
Cocotte verre	205
Cocotte vaisselle	208
Cocottes grès blanc	155
Cocottes Pyrex	205
Cognac vap Arc	54
Cognac vap Mondial	54
Colette cocottes fonte	194
Colorama	188
Colors Broadway	31
Colosseo Vap	39
Comfort balance	265
Compact balance	265
Compotiers	147
Compotiers porcelaine	156
Comptoir vap	47
Confituriers	215
Congélation plat	206
Conique mini	72
Conique Onis	53
Conique ramequin	157
Conique Timeless	41
Coniques chopes	63
Conservation	206
Conservation boîtes	210
Consommé bol	168
Consommé bols Opal	151
Contour couverts	223
Cook & Freeze	206
Cook & Heat	206
Cook and Enjoy Pyrex	207
Copa moulines	241
Copa planches	250
Coquetiers	155
Couille Saint Jacques	155
Corbeille papier	266
Corbeilles pain	154
Corbeilles pain jonc	258
Corps Chauffe	218
Coudé cuillers	236
Coulis moulin	248
Coupe Brio	57
Coupe Disco	56
Coupe dish White	150
Coupe élégance	33
Coupe Evolution	150
Coupe Symétrie	7
Couppelles Boral	98
Couppelles caféteria	147
Couppelles carré	157
Couppelles Opal	151
Couppelles porcelaine	139
Couppelles So Urban	209
Couppelles Venus	94
Couperet Universel	260
Coups grès blancs	156
Courbé spatule	261
Couscoussier	195
Couteau hûtre	237
Couteaux Artisan	260
Couteaux cuisine	260
Couteaux hûtre	155
Couteaux manche bois	235
Couteaux steak	232
Couteaux steak manche noir	235
Couteaux Studio	261
Coutellerie	260
Couvercle GN Bacs	202
Couvercle GN1/1 plast	263
Couvercle Onctuose	158
Couvercles Familia Wiss	215
Couvercles GN polypro	203
Couvercles saladiers	209
Couvercles silicone	196
Couverts Nature	233
Couverts salade bois	251
Couverts set 4 pièces	236
Couvre confitures	215
Couzon plats inox	253

Crachoir	17
Crème Colorama	188
Crème coupe Bonna	189
Crème moules	199
Crémier inox	252
Crémiers blanc	77
Crèpière Colorama	189
Creuse coupe Bonna	120
Creuse coupe porcelaine	137
Creuses Autonomy	148
Creuses pastas porcelaine	145
Croco couteaux	237
Cross Stack Up	63
Crustacés	237
Crystall Glass Arcoroc	31
Cuiller bois	263
Cuiller chinoise	156
Cuiller glace	245
Cuiller mesure	264
Cuiller servir inox	262
Cuillère glace	236
Cuillers nylon	262
Cuisine couteau	260
Cul de poule saladiers inox	154
Cuvette	266
Cylindriques tasses Opal	151

## D

Daily Baguette	231
Damier salière	242
Décapsuleur	257
Découper couteaux	260
Dégustation vap Cognac	54
Delta	104
Deluxe	244
Demi-Sphérique	159
Derin coupelles verre	159
Deshydrateur	249
Desosser couteaux	260
Diamant Estrella	43
Diamant Maeva	159
Diamante	19
Diamond chope	67
Diamond color	67
Diamond coupe	158
Diamond mini	158
Diapason	260
Disco vap	29
Distinction vap	8
Distributeur savon	247
DOC vap	18
Domaine vap	35
Dome plat tarte	152
Doseur Pyrex	264
Double pari chopes	167
Double pari tasses	164
Draft vap	50
Drakkar couverts	224
Dream flûte	58
Dublino shot Bormioli	160
Dune corbeilles	258
Dune grès	129
Duos double pari	167
Duralex	66
Duralex assiettes	152
Duralex Picardie	66

## E

East White	116
Easy Inox	184
Easynox	182
Ebro bol	151
Eco couverts	222
Ecriture marmite	197
Eden	51
Egouttoir vaisselle	247
EGP porcelaine	138
Electra chope	69
Elegance Novastyl	71
Élégance Vap	33
Eliott	263
Elisa gobelets	34
Elisa Vap	34
Elixir bouteilles	74
Ellipse cabernet	82
Elysia Pasa	43
Email frikteuse	197
Email réactif	126
Emaux réactifs	95
Emerald Primary	9
Emperor Steak	235
Empilable Duralex	66
Empilable gobelets	61
Empilable Novastyl	48
Empilable saladiers	153
Empilable verrine	160
Empilables saladiers	153
Empilables tasses	168
Endeavor chopes	53
Enoteca vap Pasa	46
Ensemble carafe	76
Entonnoir confiture	248

Entonnoir inox	248
Enzo OGO	162
Eplucheur cuisine	261
Equip Home vap	32
Escargot fourchette	155
Escargots plats	155
Eskale chopes	65
Eskale mise en bouche	161
Esméralda couverts	232
Espagnol ensemble	266
Esprit chopes	52
Essence Pasa	44
Essential cocotte	205
Essential Pyrex	207
Essoreur mop	266
Essoreuses salade	246
Este Bormioli Rocco	62
Estrella	43
Étiquettes Le Parfait	215
Etna RCR	26
Etruria Tiki	27
Europa porcelaine	138
Ever vap Classico	17
Every Day	150
Evidence vap	9
Evolution Black	150
Exalt Sensation	10
Exaltation flûtes	59
Exaltation vap	8
Exclusiva vap	38

## F

Facets	53
Facile Inox	182
Faience Amati	135
Faience Capria	134
Faitout First	185
Faitout Triply	177
Familia Wiss	214
Faustine Bleu	132
Faustine Rose	133
Fauteuil bar	270
Fauteuil bouclette	278
Fauteuil Calypso	272
Fauteuil lounge	274
Fauteuil Montauk	273
Fauteuil pivot	277
Fauteuil pivotant	278
Fauteuil table	275
Feston	151
Fiesta cocktail	55
Fil dessous plat	251
Filet bordeaux Opal	149
Filet or porcelaine	140
Filla OGO	234
Film rouleaux	249
Financiers moules	201
Finesse Nude	45
First alu	187
First Inox	185
Fizz Bach	20
Fizz Novecento	38
Fizz Roma	21
Flan moule	155
Flex spatules	261
Flora vases	243
Floralit Noir	132
Florence vap	49
Floriant Bormioli	37
Fluid carafes	75
Fluid Frosted	75
Fluté verre	13
Flûtes champagne	59
Flûtes cristallin	59
Flûtes point mousse	37
Flûtes Tre Sensi	36
Focus Allegra	46
Fond lourd chope	72
Fond piqué flûte	59
Fondue assiettes	144
Fontaine verre	60
Fonte tajines	195
Fonte théières	163
Food box	209
Forgé couverts	228
Forgé poêles	190
Forté Vina	14
Fortuna coupe	158
Forum Arcoroc	65
Fouets	262
Fourch servir inox	262
Fourchette découper	260
Fourchettes escargot	237
Fourchettes huitre	237
Fourette fauteuil	279
Fraicheur bouteille	73
France Made in	177
Frigo pichet	77
Friteuse air chaud	216
Friteuse Colorama	217
Friteuse Nord	197
Frosted Fluid	75
Fruits de Mer	237
Fuji fonte	163

Funky pivot	277
Fusil	260
Fusil Pro Classique	260
FW terrines	214

## G

Galaxy pastas	143
Galéa	4
Galetière Colorama	189
Gant silicone	237
Gaspard chaise	276
Gastronormes bacs	202
Gatsby	51
Génération assiettes	152
Génération gobelets	71
Génoise couteau	260
Giara bouteilles	73
Gigogne gobelets	66
Gin gobelets liqueur	161
Gin Tonic SPKSY	52
Gin Tonic Timeless	40
Gina chaise	274
Ginette fauteuil	274
Givré Finition	226
Glace Timeless	40
Glaçons cuillers	236
Glen Novastyl	48
Glitch The Tiki	60
Gloire Bonna	117
GN bacs couverts	263
GN bacs gastronormes	202
Goliath couteau steak	234
Gourmet Knidos	88
Gourmet passion	121
Gourmet Viento	117
GP Gin	161
Granity chopes Arcoroc	65
Granity mini	161
Graphite tisanière	165
Grappe V. Juliette	30
Gratin inox	253
Great Gastby	23
Grenada OGO	100
Grès Novastyl	129
Grès OGO	98
Grès Oli	96
Grès pichets	162
Grillades 2 rivets	235
Gris Vita	169
Gustave théières	164
Gustave tisanière	164

## H

Habana Bormioli	67
Hachoir ail	248
Hachoir viande	248
Hampshire	53
Harena Stairo	151
Harmony Filla	233
Harry plats	196
Havane couverts	230
Havane jungle couverts	230
Hawai moullins poivre	239
Haworth Bock	55
Haydn Filla	233
Heat System Opal	148
Hel tasses porcelaine	168
Hemingway	23
Hera tasses	164
Heraclée	130
Hêtre dessous plat	251
Hobstar chopes	53
Home Equip vap	32
Hôpital assiettes	148
Hornfels Bonna	120
Hot Shot	161
Huitre fourchette	237
Hurricane	33

## I

Ica sets de table	259
Ice Barshine	67
Ice Blue chopes salto	70
Icon Onis chopes	53
Iconics jattes	207
ID FINE	104
Impérial Pasa	107
Impérial Séquence flûte	9
In alto gobelet	69
In Alto Tre Sensi	36
Inao Novastyl	48
Inao Pasa	46
Infuseurs	166
Inox corbeilles	253
Inox Easy	184
Inox marmite	197
Inox moullins	239
Inox plats escargot	155
Inox Pro S	180
Inox Profi	265

Inox ramequins	253
Inox saladiers	154
Instinct couverts	226
Inverness chopes	53
Invitation mise en bouche	160
Iris amovible	184
Iris inox	184
Iris sets de table	258
Irish Coffee	54
Irresistible Pyrex	206
Islande chopes	72
Islande minis	161
Ivento Vap	15
Ivoire Vita	169
Ivory vap	47

## J

Jacinthe d'eau sets table	258
Jade grès	131
Jade Primary	9
Jaipur grès	130
Jambon couteau	260
Japan carré porcelaine	139
Jardin salon	271
Jasmin	128
Jatte borosilicate	204
Jauge Grappe	11
Jauges verres	82
Jaune Kuwae	154
Jazz glaces	159
Jazzed coupe	159
Jean's Brush	149
Jet couverts	229
Jeunes Vins Cabernet	10
Joints Le Parfait	215
Jolly	54
Joy	44
Juliet	162
Juliet tisanière	162
Juliette Vina vap	30
Jumbo couteau	235
Jungle Havane couverts	230
Jute naturel sets table	259
Jute set de table	259

## K

K porcelaine	103
Kaffe Gloire	117
Kalix vap	39
Karl Ambre	165
Katanga OGO	100
Kazub tasses porcelaine	168
Keygo	166
Kitchen Lab	264
Klip pouibelle	266
Knidos	88
Krysta	7
Kuwae mélamine	154

## L

Lachat Bonna	127
Lagoon Ocean	112
Lal vap	49
Lasagne Pyrex	207
Laska	164
Latino	55
Lav verres	49
Lavande boîtes	210
Lave pont	266
Le Parfait	213
L'Eau chope	69
Leaves sets de table	259
Leerdam Vap	52
Légumiers inox	154
Légumiers inox	253
Leia tasses	164
Léo moullins	240
Léopard	51
Lévrier tire-bouchon	257
Libbey Perception	52
Lima Arc chopes	10
Lima ménagères	227
Limonadier	257
Linéal vap	35
Linz chopes	55
Lion souprière	155
Lodge incliné porcelaine	144
Log gobelets trempé	64
Lola	66
Lola Duralex	66
Longham chopes	31
Longham West Loop	31
Loop west chopes	31
Lotus coupelle	156
Louche inox	262
Louchebém couteau steak	235
Louches cuisine	262
Louches inox pro	262
Louis XV plateaux	253
Louis XV porcelaine	110

Louise	227
Lounge Barware	62
Lounge Rock Bar	67
LPS Color Vis	213
Lubiana porcelaine	142
Luca Mozaic	118
Luminarc feston	151
Luminarc Roman	32
Luna chopes	69
Luna sets de table	258
Lunar Ocean	119
Lybra chopes	69
Lyon gobelets	67
Lyonnais	76
Lys chopes Duralex	66

## M

Machines sous vide	218
Magenta cuisson	188
Magnifique verre à pied	30
Maka porcelaine	126
Maléa chopes	70
Manche balai	266
Mandoline Deluxe	244
Manhattan Duralex	66
Manille couverts	224
Manivelle Auguste	166
Manivelle moulines	240
Manqué acier moules	199
Manqué moule	200
Manque Pyrex	207
Margarita	56
Marguerita	56
Marine Duralex	66
Marjolaine	156
Marmite	196
Marmite moule	197
Marmite Inox Pro	180
Marqueurs	215
Mariot porcelaine	146
Martelé couteau steak	235
Martelé porcelaine	143
Martin Buffet	262
Martini	57
Martini Brio	57
Maryse Eliott	263
Masquerade Broadway	31
Masquerade ex Broadway	31
Matignon vap	48
Mazagan cuiller	236
Mélatine	154
Mélatine Rivage	154
Mellow	106
Melodia	27
Ménage	266
Ménage articles	266
Ménagères sel-poivre	242
Ménastyl accessoires	244
Ménastyl Batch Cooking	211
Ménastyl boîtes	211
Ménastyl Cerise	191
Ménastyl Colorama	188
Ménastyl cuisson	191
Ménastyl Cristal	208
Ménastyl Fonte	194
Ménastyl France	177
Ménastyl moulines	241
Ménastyl PEM	219
Menthe chopes	67
Meravigliosi	23
Métropole couverts	230
Metropolitan porcelaine	137
Michelangelo vap	18
Microdenté couteaux	234
Milano chopes	39
Milano New Kalix	39
Mint Barshine	67
Mister Chef saladiers	153
Misure carafes	76
Mixo Diamante	68
Mixology Elysia	43
Mixology Vap	19
Mixte cuiller croco	237
Modest ID Fine	111
Mojito verres	61
Moka valmy	236
Mokas cuillers	236
Mona théière	162
Mondial Vap	14
Mont Blanc couteau	235
Montauk salon	273
Monte-Carlo Vap	44
Monture inox bocal	213
Mop	265
Moule marmite	197
Moules acier carbone	201
Moules Acier TK	200
Moules cuisson	216
Moulin café	166
Moulines Coloré	241
Moulines poivre et sel	239
Moutardiers	242
Mozaic Luca	118
Mr Chef saladiers	153

Muffin moules	201
Mug paille	60
Mugi théière	164
Mugs grès blanc	169
Mugs Opal	151
Mugs verre	167
Mules Bormioli	60
Muscade moulines	240
Mylla	5

## N

Nadia tasses porcelaine	168
Nagoya	50
Napoli	271
Narok Mise en bouche	160
Natura	127
Nature OGO	233
Naturel bois moulines	240
Néo vap	12
New Kalix chopes	69
New Martini cocktail	57
New York Arcoroc	64
Nexo vap Bormioli	36
Next empilable	61
Nice vap	49
Nick & Nora Bormioli	38
Nick & Nora Disco	9
Nick & Nora Mixology	9
Nick & Nora Timeless	40
Nick & Nora vap	52
Noa vap	49
Noir brosse WC	266
Noir cendriers	243
Noir chopes	9
Noir couteau steak	235
Noir First	187
Noir Floral	132
Noir ID Fine	109
Noir Opal	150
Noir porcelaine	111
Noisette moules	199
Nonic Arcoroc	65
Nonik	46
Nonix	39
Normandie Vap	34
Norvege Arcoroc	65
Note de musique	17
Nova Aquitania	148
Nova gres OGO	97
Novastyl Atome	122
Novastyl blanc porcelaine	136
Novastyl couleur	50
Novastyl couverts	227
Novastyl Grès	129
Novastyl grès	130
Novastyl Natura	127
Novecento chopes	62
Novecento cocktail	38
Now's Home mobilier	271
Nuance porcelaine	123
Nylon balai	266
Nylon louche	262

## O

O Cuisine plats	204
Océan couverts	223
Ocean Lagoon	112
Océan Lunar	119
Océanie OGO	231
Octave	198
Octave ramequin	157
Office bois	235
Office manche PP	261
Office polypro	261
OGO accessoires	257
OGO couverts	231
OGO émaux réactifs	95
OGO Omega	102
OGO porcelaine	90
OGO porcelaine	92
OGO pro inox poêles	180
OGO thé et café	164
OGO théières	164
OGO Tisanières	162
OGO Urus	90
OGO vaisselle	98
OGO vap	59
Olga couverts	223
Oli OGO	96
Olive cuisson	188
Omega	102
Onctuose	158
One The vap	15
Onis	53
Opal assiettes Restaurant	149
Opal tasses	149
Open Up Chopes	6
Open Up vap	6
Optica Speakeasy	23
Optima carafes	74
Optima condiments	242
Optiva	156

Or assiettes filet	140
Ora OGO	92
Orange brush	149
Oreille bol parisien	157
Oreilles rondelles	215
Organisateur évier	247
Oriente bouteille	74
Origin couteaux	260
Osaka théières	163
Oscar	266
Oscar théière	164
Oslo blanc porcelaine	147
Oslo bol	156
Oslo vap	13
Outline Arcoroc	70
Oval coupe	158
Oval Delta	105
Oval Knidos	88
Oval plats	156
Ovenchef Ramequin	157
Oxford	62
Oxygene Arcoroc	65

## P

Pack terrines	214
Page balance	265
Pain assiettes carré porc	139
Palmeraie	124
Palmier coupe	159
Paneled chopes	53
Panier cloche	258
Panier frites	154
Panier friteuse	197
Panier vapeur	207
Panières jonc	258
Papier moule friteuse	216
Paris moulines OGO	240
Paris sel & poivre	242
Parisien bol	157
Pasa empilable	61
Pasabahce	44
Pasabahce saladiers	153
Pasabahce Trempe	61
Passion gourmet	121
Passoire inox	253
Pasta Martelé	143
Pastas Galaxy	143
Pâtes assiettes porcelaine	136
Pâtes creuses	145
Patio salon	271
Pâtisserie Pyrex	207
Paula plateau	168
Paula tasses porcelaine	168
Peach Barshine	67
Peche chopes	67
Peint main assiettes	121
Pelle balayette	266
Pelle tarte	262
PEM Menastyl	219
Pentagon Onis	53
Pepite coupe à glace	158
Percolateur	218
Perforé bacs gastro	202
Perforé moules	201
Personnalisés verres	82
Personnes âgées assiettes	148
Pèse-personne	265
Picardie assiettes	152
Picardie Duralex	66
Pichets grès blanc	77
Pichets verre	77
Pierre Boral	99
Pince crustacés	237
Pince service	261
Pinces bacs GN	202
Pinces Buffet	262
Pinces escargot	155
Pinces glaçons	261
Pinces linges	267
Pineapple	60
Pinot chope Supremo	21
Pique bigorneaux	237
Pizza blanc porcelaine	136
Pizza couteau steak	235
Pizza couteaux	235
Pizza ID Fine	106
Pizza Viento	117
Planche pizza	250
Planches plastique	246
Planches Polypro	251
Plane aile porcelaine	142
Plaque four acier	200
Plaque pizza acier	200
Plastique boîtes	246
Plastique sets table	259
Plat carré Octave	198
Plat gâteau porcelaine	144
Plat grille grès	198
Plat œuf blanc	156
Plat œuf mini	156
Plat ovale grès	198
Plat rond grès	198
Plat rôti avec grilles	196
Plateau fruit de mer	237

Plateau inox	252
Plateaux mélamine	251
Plats acier	199
Plats Airfryers	205
Plats borosilicate	204
Plats creux inox	196
Plats escargot inox	155
Plats escargots	155
Plats feston opal	151
Plats gratin	156
Plats gratin inox	154
Plats gratin verre	204
Plats grès blanc	156
Plats ronds	156
Plats verre	152
Plats verre	152
Poêles alu	191
Poêles Alu Pro	186
Poêles friré émail	197
Poêles intérieur inox	180
Poêles Triply	177
Poignée mandoline	244
Poisson poêle	180
Polo porcelaine	138
Polyéthylène couvercle	209
Polypro planches	251
Polypropylène bacs	203
Pompe main	249
Pompe vin	256
Pony Nude	45
Porcelaine OGO	92
Porcelaine coupe blanche	137
Porcelaine ID Fine	104
Porcelaine Novastyl	128
Porcelaine Nuance	123
Porcelaine Omega	102
Porcelaine Palmeraie	124
Porcelaine renforcée	147
Porcelaine sel & poivre	242
Porte filtre	166
Porte ustensile	247
Porte-couverts	263
Pot lait inox	252
Pot Lyonnais	76
Potage bol	151
Pots confitures	215
Pots inox	166
Poule coquetier	155
Presicio	264
Pressbox	210
Presse agrume	248
Presse ail	244
Presse citron verre	248
Primary chopes	9
Primary Color	9
Princesa Vap	35
Prisme Duralex	66
Pro Alu Menastyl	186
Pro inox cuisson	180
Pro Tasting	6
Professionnel Tre Sensi	36
Professionnel casseroles	180
Profi balance	265
Pulcinella	60
Pure chopes Schott Zwiesel	15
Pure Nude	45
Pure vap Belfesta	15
PVC sets table	259
Pyrex	206
Pyrex congélation	206
Pyrex doseurs	264
Pyrex O Cuisine	204

## Q

Quadro brocs	77
Quadro coupe	159
Quattro Stagioni	60

## R

Raclette embout	266
Radiant	53
Rafraichisseur inox	252
Rafraichisseur vin	256
Ramequin blancs	157
Ramequin Cafétéria porcelaine	147
Ramequin Cannelle	157
Ramequin Duralex	157
Ramequin grès	157
Ramequin Lyon	67
Ramequins inox	157
Ramequins trempé	157
Range couverts	263
Râpe fromage	243
Ravier verre	157
Raviers Delta	105
Raviers grès blanc	156
Raviers Opal	151
Raviers Sarreguemines	147
Raviers verre	157
RCR	24
Reactif émail	126
Reckless	109

Rectangle Alaska	137
Rectangle Square	139
Rectangle Vago	120
Rectangles carpaccio	146
Recyclé aluminium	187
Recyclé moulines	240
Red Flash	191
Regal mise en bouche	160
Régence plats inox	253
Regethermie	148
Réhausse casier	263
Reims flûte	58
Restaurant Slim Opal	150
Restaurant Uni Opal	149
Resto uni couverts	222
Rétro Joy	44
Réverie carafe	78
Réverie Cognac	49
Revêtement céramique	187
Revêtu cuisson inox	179
Rhin jambe verte	48
Rhum vap Cognac	54
Riga grès	167
Rita coupe inclinée	144
Rita Lodge saladiers	143
Rita Steak porcelaine	146
Rita tasses Bonna	89
Riva chaise	276
Rivage Mélaamine	154
Rivera Bleu	50
Rivera Vert	50
Rivets couteaux steak	261
Riviera Orange	50
Riz bol porcelaine	156
Rock Bar coupe	158
Rock Bar gobelets	67
Rock Bar Mini	160
Rocks Tarq	53
Roissy couverts	236
Roma 1960 vap	21
Roma by Luigi Bormioli	21
Roma chopés	21
Roma GAPB	143
Roma vap by Onis	52
Roman vap	32
Rondelles bocalaux	215
Rondo	48
Rose Colorama	188
Rose Faustine	133
Rouge Fonte	194
Rouge porcelaine	121
Rouge Salto chopés	70
Rouleaux film	249
Roulette pizza	245
Round Open Up	6
Royal Leerdam	52
Rubino vap	18

## S

Sacs sous vide	249
Safran poêles	188
Sahara Tone	113
Saladier bois	251
Saladiers antidérapants	154
Saladiers Arcoroc	153
Saladiers inox	154
Saladiers Opal	151
Saladiers Restaurant	151
Saladiers verre	152
Salière bouchon inox	242
Salon jardin Calypso	272
Salon jardin Mautauk	273
Salon jardin Patio	271
Salto ice blue	70
Salto mini	161
Salto Rouge	70
Sand	48
Sangria cuillers	236
Santoku couteau	260
Santuko Artisan	260
Sarreguemines porcelaine	147
Satiné baguette	231
Saturne	95
Saucière Aronal	98
Saucière inox	252
Saucière Kaffe	117
Saupoudreuses	242
Sauteuse Inox	180
Sauteuse inox	185
Savage Nude	45
Savane	129
Savoie Vap Arcoroc	33
Sculptes verres	37
Seau	266
Seau glace inox	252
Seau inox	252
Seau isotherme	252
Seaux brasserie inox	252
Seb cocotte-minute	196
Séchoir tour	267
Sel poivre blanc	242
Sensa Zwiesel	17
Sensation Exalt	10
Sense steak	235

Sensus	17
Sentido Irish	54
Séquence vap	9
Serenity	61
Serpillère	266
Sets cuisson Easynox	183
Sets de table	258
Sets saladiers	209
Sets table PVC	259
Seychelles coupe	158
Shaker Barman	257
Sheland chopés	63
Shetland mini	161
Shooters	160
Shot Hot mise en bouche	161
Shots Boston	160
Siam set de table	258
Sigma porcelaine	93
Silhouette vap	33
Silicone accessoires	216
Silicone couvercles	196
Silicone louche	263
Silicone moules	201
Silk gobelets	69
Slim couverts	224
Slim Restaurant	150
Snack set	209
Snacking couverts	236
Snifer cognac bière	54
So Urban	209
Soda cuillers	236
Soft Open Up	6
Sole filet couteau	260
Son'hyx	18
Sorbet coupe	158
Soucoupes verre	167
Soufflé moules blancs	157
Soufflé Pyrex	207
Soupière TDL	155
Soupière tête de Lion	155
Sour Cocktail	60
Sous vide machine	249
Sous vide sacs	249
Space Gourmet	121
Spatule bois	263
Spatule silicone	263
Spatules Flex	261
Speakeasy	52
Speakeasy Swing	23
Speciality Opal Black	150
Sphérique coupe	159
Spirale	124
Spirales Viticole	82
Spirit Bar	54
SPKSY vap	52
Splendid Vina	32
Spring broc	77
Spritz Timeless	24
Square porcelaine	139
Square Top Class	68
Stack RCR	25
Stack Up chopés	63
Stack Up Cross	63
Stack Up mini	161
Stairo Arcoroc	151
Starline	63
Steak couteaux	234
Steak manche PP	234
Steak Opal	149
Sterilisateur Inox	212
Sterilisation bocalaux	214
Stockholm chope Arc	72
Stockholm mini	161
Stone Barware	62
Studio couteaux	261
Sublym vap	7
Super Le Parfait	214
Support seau champagne	252
Supremo vap	59
Surf gobelet	71
Sweet Cocktail	60
Swing bouteille	74
Swing Speakeasy	23
Swing Top Le Parfait	73
Symétrie flûtes	59
Symétrie vap	7

## T

TA élégance	33
TA normandie	34
Table Bel Air	272
Table et fauteuil	272
Table métal	272
Table repasser	267
Tabouret bar	270
Tajine fonte	195
Tajine grès blanc	155
Tam Tam couverts	232
Tannic Open Up	6
Tapas bodéga	71
Tapas fourchette	222
Tapis caoutchouc	266
Tarq Onis	53
Tarte acier moules	199

Tarte moule Octave	198
Tarte plats	152
Tartineur couteau	236
Tasse Oslo	147
Tasses empilable	168
Tasses empilable porcelaine	168
Tasses Kaffe Bonna	117
Tasses Karl	165
Tasses Opal	151
Tasses verre	167
Taste vap	17
Tattoo	25
Tequila Backdoor'20s	23
Terracota Octave	198
Terrine Le Parfait	214
Terrines blanc	155
Terrines Le Parfait	214
Terrines rectangles grès	155
Terrines Wiss	214
Tête balai nylon	266
Tête de Lion soupière	155
Thé infuseurs	166
The One vap	15
Théière verre	164
Thermomètre	256
Thera porcelaine	103
Thermic Glass	167
Thermomètres	264
Tiffany	110
Tiki	60
Tiki Sardinia	60
Tiki Split	60
Timeless Pasabahce	40
Timeless RCR	24
Tire bouchon	254
Tire rondelles	215
Tirettes homard	237
Tisannières	162
Tisannières verre	165
Tissage set table	259
Tissé sets de table	258
TK moules	201
Top Class chopés	68
Top of stove	182
Toqueur œufs	243
Torqueur	71
Tourtière Octave	198
Tower	46
Tower Novastyle	49
Tradition couteau steak	234
Tradition vieux Paris	225
Tranche-lard	260
Trappeur couteau	235
Tre Sensi Inalto	36
Trempe Bormioli	39
Trempe verres	61
Triangle spatule	261
Trinox	178
Trinox revêtu	179
Triply Inox	177
Trudeau moulines	241
Tube chope islande	72
Tube Timeless	41
Tulip bière vap	49
Tulip Cabernet	11
Tulip vap Pasa	44

## U

U porcelaine	102
Ulysse	278
Uni Couzon plateaux	253
Universal Open Up	6
Universelles rondelles	215
Uno In Alto	36
Urban So Arcoroc	209
Urus by Ogo	90

## V

V. Juliette	30
Valmy couverts	222
Vases	243
Vasque champagne	252
Vega lumignon	161
Venezia	27
Venus porcelaine	94
Verre assiettes	152
Verre mesure	264
Verre saladiers	153
Verres bière	55
Verres doseur	264
Verrines bocalaux	214
Versailles	167
Verser pots inox	166
Vert brush	149
Vert cocotte fonte	194
Vert Heraclée	130
Vert Octave	198
Verte filet	111
Verte Natura	127
Vésuve moka	236
Vide poche blanc	243
Viento Bonna	117

Vieux Paris BG couverts	225
Vieux Paris satiné couverts	225
Vieux Paris tradition	225
Viggo théières OGO	163
Vigne chopés	8
Vigne mise en bouche	161
Viktor	78
Village carafes	73
Vin au Verre	82
Vina chopés Arcoroc	70
Vina chopés Juliette	70
Vina Juliette	30
Vina piscine	32
Vina Schott Zwiesel	14
Vina vap Arcoroc	32
Vinciana vases	243
Vins Jeunes Carbenet	10
Vintage Arès	231
Vinyl sets de table	259
Vira coupelles verre	159
Virgule steak	234
Vis tire bouchon	254
Vita ivoire	169
Viticole vap	32
Vitrified Bonna	88
Vodka West Loop	31
Volcano Novastyl	95
Volcano steak	235
Voluto	167
Vulcano	267

## W

Warm Open Up	6
Wassingue	266
Weizenbier	54
Wells	55
Wersal porcelaine	142
Wersal tasse porcelaine	168
Wersal théières	162
West Loop	31
Whisky Top Class	68
White Opal blanc	150
White porcelaine	136
White saladiers porcelaine	136
Willi becher	70
Winchester chopés	53
Wok poêle inox	177
Wok Triply	177
Wood planches	250

## X

Xtratuff	52
XXL Cognac	54

## Y

Yack fauteuil	279
Ycare infuseur tube	166
Ypsilon carafes	76
Ypsilon chopés	63
Ypsilon cocktail	57
Ypsilon coupe glace	158

## Z

Zenith Ogo	12
Zwiesel	14
Zwiesel Taste	17

Code.....Page

0

0212001.....218  
 0212002.....218  
 0212003.....218  
 0212005.....218  
 0661098.....265  
 0861505.....265  
 0861506.....265  
 0861507.....265  
 0861509.....265  
 0861515.....265  
 0861516.....265

1

1029100.....257  
 1029831.....32  
 1210112.....215  
 1210185.....215  
 1210189.....215  
 1210190.....215  
 1210191.....215  
 1210193.....215  
 1310018.....167  
 1310155.....264  
 1310205.....157  
 1310570.....153  
 1310572.....153  
 1310573.....153  
 1310574.....153  
 1310575.....153  
 1310576.....153  
 1310577.....153  
 1310638.....66  
 1310640.....66  
 1450010.....206  
 1450011.....206  
 1450012.....206  
 1450013.....206  
 1450014.....206  
 1450015.....206  
 1450016.....206  
 1450017.....206  
 1450032.....207  
 1450033.....207  
 1450035.....207  
 1450036.....207  
 1450040.....208  
 1450074.....205  
 1450076.....205  
 1450082.....207  
 1450094.....205  
 1450096.....205  
 1450098.....205  
 1450116.....207  
 1450117.....264  
 1450118.....207  
 1450119.....264  
 1450121.....264  
 1450123.....264  
 1450124.....264  
 1450125.....264  
 1450126.....264  
 1450127.....264  
 1450140.....205  
 1450141.....205  
 1450142.....205  
 1450143.....205  
 1450144.....205  
 1450151.....207  
 1450152.....207  
 1450153.....207  
 1450155.....207  
 1450156.....207  
 1450157.....207  
 1450158.....207  
 1451004.....206  
 1451005.....206  
 1451006.....206  
 1451007.....206  
 1451018.....206  
 1451022.....206  
 1451023.....206  
 1451024.....206  
 1451025.....206  
 1459003.....204  
 1459004.....204  
 1459005.....204  
 1459009.....204  
 1459018.....205  
 1459039.....204  
 1459040.....204  
 1510006.....214  
 1510007.....214  
 1510008.....214  
 1510009.....214  
 1510010.....214  
 1510011.....214  
 1510024.....214  
 1510025.....214  
 1510026.....214  
 1510027.....214  
 1510028.....214  
 1510029.....214  
 1510052.....215  
 1510060.....215  
 1510061.....215  
 1510062.....215

1510064.....215  
 1510070.....215  
 1510071.....215  
 1510072.....215  
 1510096.....215  
 1510145.....214  
 1510146.....214  
 1510147.....214  
 1510148.....214  
 1510149.....214  
 1510150.....214  
 1510151.....214  
 1510230.....73  
 1510231.....215  
 1510235.....73  
 1510236.....215  
 1510240.....215  
 1510241.....215  
 1510242.....215  
 1510245.....247  
 1510248.....215  
 1510250.....215  
 1510258.....215  
 1510259.....215  
 1510290.....249  
 1510291.....249  
 1510292.....249  
 1510315.....213  
 1510316.....213  
 1510317.....213  
 1510318.....213  
 1510319.....213  
 1510324.....213  
 1510325.....212  
 1510326.....212  
 1510328.....248  
 1510329.....248  
 1510332.....248  
 1510341.....248  
 1510345.....249  
 1510346.....249  
 1510348.....249  
 1510361.....213  
 1510365.....213  
 1510370.....213  
 1510372.....213  
 1510376.....213  
 1510385.....249  
 1510386.....249  
 1510387.....249  
 1510388.....249  
 1510389.....249  
 1510390.....249  
 1510391.....249  
 1510392.....249  
 1604140.....66  
 1605028.....60  
 1605029.....60  
 1605080.....60  
 1605085.....264  
 1605091.....77  
 1605092.....78  
 1605093.....78  
 1605105.....243  
 1605383.....55  
 1605435.....50  
 1605436.....50  
 1605437.....50  
 1605438.....50  
 1605440.....50  
 1605441.....50  
 1605442.....50  
 1605443.....50  
 1605445.....50  
 1605446.....50  
 1605447.....50  
 1605448.....50  
 1605450.....51  
 1605451.....51  
 1605452.....51  
 1605455.....51  
 1605456.....51  
 1605457.....51  
 1605458.....51  
 1605460.....51  
 1605461.....51  
 1605462.....51  
 1605463.....51  
 1610135.....77  
 1610136.....77  
 1610137.....77  
 1611465.....160  
 1611480.....49  
 1611493.....167  
 1611582.....40  
 1611634.....78  
 1611635.....78  
 1611720.....73  
 1611721.....73  
 1611722.....73  
 1611878.....153  
 1611879.....153  
 1611880.....153  
 1611881.....153  
 1611882.....153  
 1611883.....153  
 1611884.....153  
 1611889.....209  
 1611965.....71  
 1611970.....71  
 1613027.....47  
 1613041.....47  
 1613060.....44

1613061.....44  
 1613062.....44  
 1613063.....44  
 1613064.....58  
 1613065.....44  
 1613081.....43  
 1613082.....43  
 1613083.....57  
 1613084.....160  
 1613085.....43  
 1613086.....43  
 1613087.....43  
 1613088.....43  
 1613110.....61  
 1613111.....61  
 1613112.....61  
 1613113.....61  
 1613114.....61  
 1613140.....61  
 1613186.....40  
 1613188.....40  
 1613189.....40  
 1613191.....40  
 1613192.....40  
 1613193.....40  
 1613214.....160  
 1613215.....41  
 1613216.....40  
 1613217.....41  
 1613218.....41  
 1613223.....41  
 1613224.....40  
 1613225.....41  
 1613226.....41  
 1613227.....41  
 1613228.....41  
 1613235.....71  
 1613242.....152  
 1613243.....152  
 1613244.....152  
 1613280.....152  
 1613281.....152  
 1613282.....152  
 1613310.....49  
 1613378.....44  
 1613379.....44  
 1613380.....44  
 1613381.....44  
 1613382.....44  
 1613383.....44  
 1613425.....49  
 1613430.....49  
 1613440.....49  
 1613504.....157  
 1613630.....47  
 1613860.....243  
 1613862.....243  
 1615300.....68  
 1615301.....68  
 1615500.....167  
 1615501.....167  
 1615502.....167  
 1615510.....167  
 1615513.....167  
 1616130.....77  
 1616131.....77  
 1616132.....77  
 1616139.....243  
 1616155.....76  
 1616156.....76  
 1616157.....76  
 1616648.....76  
 1616649.....76  
 1616650.....76  
 1618040.....160  
 1618062.....160  
 1618070.....48  
 1618083.....160  
 1618084.....160  
 1618098.....50  
 1618152.....48  
 1618250.....73  
 1618251.....73  
 1618257.....49  
 1618290.....48  
 1618291.....48  
 1618307.....159  
 1618308.....159  
 1618317.....159  
 1618318.....159  
 1618319.....55  
 1618331.....48  
 1618332.....69  
 1618333.....48  
 1618334.....71  
 1618371.....49  
 1618375.....49  
 1618376.....49  
 1618377.....49  
 1618396.....49  
 1618397.....54  
 1618496.....71  
 1618497.....71  
 1618595.....47  
 1618596.....47  
 1618597.....47  
 1618610.....61  
 1618611.....61  
 1618612.....61  
 1618826.....152  
 1618832.....49  
 1618833.....49  
 1618834.....49

1631105.....76  
 1631106.....76  
 1631107.....76  
 1631115.....54  
 1641030.....76  
 1641031.....76  
 1660004.....151  
 1664001.....74  
 1690025.....208  
 1692036.....208  
 1692037.....208  
 1692038.....208  
 1946025.....60  
 1946026.....60  
 1946027.....25  
 1946028.....25  
 1946032.....60  
 1946033.....27  
 1946185.....26  
 1946186.....26  
 1946187.....26  
 1946188.....26  
 1946213.....26  
 1946214.....26  
 1946215.....26  
 1946216.....26  
 1946217.....26  
 1946245.....27  
 1946246.....27  
 1946247.....27  
 1946248.....27  
 1946249.....27  
 1946250.....27  
 1946259.....24  
 1946260.....24  
 1946261.....24  
 1946262.....24  
 1946263.....24  
 1946264.....24  
 1946270.....24  
 1946271.....24  
 1946272.....24  
 1946273.....24  
 1946365.....25  
 1946371.....25  
 1946372.....25  
 1946373.....25  
 1946375.....25  
 1971747.....15  
 1971748.....15  
 1971815.....48  
 1971816.....48  
 1971817.....48  
 1971885.....48  
 1971890.....48

2

2425740.....155  
 2513085.....132  
 2513086.....132  
 2513087.....132  
 2513130.....133  
 2513131.....133  
 2513132.....133  
 2513160.....133  
 2513161.....133  
 2513162.....133  
 2513395.....134  
 2513396.....134  
 2513397.....134  
 2513398.....134  
 2513400.....134  
 2513401.....134  
 2513450.....135  
 2513451.....135  
 2513452.....135  
 2513453.....135  
 2513454.....135  
 2513455.....135  
 2513456.....135  
 2513465.....124  
 2513466.....124  
 2513467.....124  
 2513470.....122  
 2513471.....122  
 2513472.....122  
 2514145.....104  
 2514146.....104  
 2514147.....104  
 2514148.....104  
 2514149.....104  
 2514150.....104  
 2514151.....104  
 2514152.....104  
 2514153.....104  
 2514156.....104  
 2514157.....104  
 2514158.....105  
 2514159.....105  
 2514160.....105  
 2514162.....104  
 2514165.....105  
 2514166.....105  
 2514167.....105  
 2514168.....105  
 2514171.....105  
 2514172.....105  
 2514173.....105  
 2514174.....105  
 2514175.....105  
 2514176.....105

2514185.....105  
 2514186.....105  
 2514187.....105  
 2514188.....105  
 2514191.....105  
 2514195.....105  
 2514201.....104  
 2514202.....104  
 2514203.....104  
 2514217.....106  
 2514219.....106  
 2514222.....106  
 2514223.....106  
 2514225.....106  
 2514228.....106  
 2514229.....106  
 2514230.....106  
 2514231.....106  
 2514241.....106  
 2514243.....106  
 2514246.....106  
 2514252.....106  
 2514271.....106  
 2514281.....106  
 2514282.....106  
 2514288.....106  
 2514289.....106  
 2514331.....111  
 2514334.....111  
 2514336.....111  
 2514337.....111  
 2514339.....111  
 2514359.....111  
 2514365.....111  
 2514370.....111  
 2514371.....111  
 2514454.....111  
 2514455.....111  
 2514456.....111  
 2514486.....111  
 2514487.....111  
 2514495.....111  
 2514497.....111  
 2514498.....111  
 2514560.....108  
 2514563.....108  
 2514565.....108  
 2514566.....108  
 2514568.....108  
 2514579.....108  
 2514586.....108  
 2514592.....108  
 2514601.....108  
 2514602.....108  
 2514611.....108  
 2514612.....108  
 2514623.....108  
 2514636.....109  
 2514644.....109  
 2514645.....109  
 2514654.....109  
 2514655.....108  
 2514665.....109  
 2514666.....109  
 2514672.....109  
 2514673.....109  
 2514674.....109  
 2514675.....109  
 2514689.....109  
 2514715.....110  
 2514716.....110  
 2514717.....110  
 2514723.....110  
 2514727.....110  
 2514728.....110  
 2514729.....110  
 2514731.....110  
 2514735.....110  
 2514736.....110  
 2514737.....110  
 2514738.....110  
 2514744.....110  
 2514745.....110  
 2615071.....138  
 2615073.....138  
 2615074.....138  
 2615075.....138  
 2615080.....138  
 2615081.....138  
 2615084.....168  
 2615085.....168  
 2615105.....126  
 2615106.....126  
 2615107.....126  
 2615108.....126  
 2615109.....126  
 2615110.....126  
 2615111.....126  
 2615294.....95  
 2615295.....95  
 2615296.....95  
 2615297.....95  
 2615298.....95  
 2615299.....95  
 2615400.....126  
 2615401.....126  
 2615402.....126  
 2615403.....126  
 2615404.....126  
 2615415.....126  
 2615416.....126  
 2615439.....139

2615440.....139  
 2615441.....139  
 2615442.....139  
 2615443.....139  
 2615444.....139  
 2615445.....139  
 2615446.....139  
 2615447.....139  
 2615448.....139  
 2615449.....139  
 2615450.....139  
 2615451.....139  
 2615452.....139  
 2615453.....139  
 2615520.....125  
 2615521.....125  
 2615522.....125  
 2615551.....145  
 2615552.....145  
 2615553.....145  
 2615560.....140  
 2615561.....140  
 2615562.....140  
 2615566.....140  
 2615568.....140  
 2615569.....140  
 2615633.....143  
 2615634.....143  
 2615650.....138  
 2615651.....138  
 2615652.....138  
 2615653.....138  
 2615654.....138  
 2615655.....138  
 2615705.....128  
 2615706.....128  
 2615707.....128  
 2615708.....128  
 2615709.....128  
 2615713.....128  
 2615715.....128  
 2615716.....128  
 2615717.....128  
 2615718.....128  
 2615719.....128  
 2615723.....128  
 2615728.....139  
 2615729.....139  
 2615730.....139  
 2615732.....139  
 2615735.....123  
 2615736.....123  
 2615737.....123  
 2615738.....123  
 2615739.....123  
 2615744.....123  
 2615779.....146  
 2615786.....146  
 2615790.....146  
 2615795.....124  
 2615796.....124  
 2615797.....124  
 2615798.....124  
 2615806.....124  
 2615807.....124  
 2615808.....124  
 2630028.....144  
 2630107.....155  
 2630108.....155  
 2630110.....155  
 2630365.....136  
 2630366.....136  
 2630367.....144  
 2630370.....137  
 2630371.....137  
 2630372.....137  
 2630373.....168  
 2630374.....137  
 2630375.....137  
 2630373.....136  
 2630374.....136  
 2630375.....136  
 2630376.....136  
 2630377.....136  
 2630378.....136  
 2630379.....136  
 2630740.....156  
 2630801.....155  
 2630863.....137  
 2630864.....137  
 2630865.....145  
 2630866.....137  
 2630867.....137  
 2630868.....137  
 2630870.....140  
 2630871.....140  
 2630872.....140  
 2632101.....119  
 2632102.....119  
 2632103.....119  
 2632111.....119  
 2632224.....120  
 2632228.....120  
 2632229.....120  
 2632230.....120  
 2632403.....89  
 2632407.....89  
 2632409.....89  
 2632476.....121  
 2632477.....121

2632485.....	121	2633326.....	115	2695055.....	147	3205897.....	131	4610459.....	202	4710132.....	260
2632487.....	121	2633327.....	115	2695056.....	147	3205898.....	131	4610464.....	202	4710134.....	260
2632508.....	121	2633328.....	115	2695057.....	147	3205925.....	129	4610465.....	202	4710135.....	260
2632509.....	121	2633393.....	89	2695062.....	147	3205926.....	129	4610466.....	202	4710136.....	260
2632571.....	121	2633394.....	89	2695063.....	147	3205927.....	129	4610467.....	202	4710139.....	234
2632574.....	121	2633395.....	89	2695069.....	147	3235135.....	130	4610468.....	202	4710220.....	223
2632575.....	121	2633397.....	88	2695070.....	147	3235136.....	130	4610470.....	202	4710221.....	223
2632576.....	121	2633398.....	88	2695071.....	147	3235137.....	130	4610473.....	202	4710222.....	223
2632578.....	121	2633399.....	88	2695086.....	147	3235138.....	130	4610474.....	202	4710223.....	223
2632579.....	121	2633400.....	88	2695087.....	147	3235139.....	130	4610476.....	202	4710225.....	223
2632582.....	121	2633401.....	88	2940002.....	155	3356052.....	157	4610477.....	202	4710226.....	223
2632583.....	121	2633402.....	88	2940003.....	157	3356060.....	156	4610478.....	202	4710242.....	235
2632586.....	121	2633403.....	88	2940004.....	157	3356125.....	198	4610479.....	202	4710248.....	235
2632587.....	121	2633404.....	88	2940005.....	157	3356126.....	198	4610480.....	202	4710260.....	235
2632648.....	114	2633405.....	89	2940006.....	157	3356127.....	198	4610481.....	202	4710263.....	261
2632649.....	114	2633406.....	89	2940007.....	156	3356130.....	198	4610482.....	202	4710264.....	234
2632650.....	114	2633407.....	89	2940018.....	156	3356131.....	198	4610483.....	202	4710287.....	235
2632651.....	114	2633409.....	88	2940025.....	156	3356132.....	198	4610489.....	202	4710385.....	225
2632652.....	114	2633410.....	88	2940026.....	155	3356135.....	198	4610490.....	202	4710386.....	225
2632653.....	114	2633411.....	88	2940027.....	155	3356136.....	198	4610492.....	202	4710387.....	225
2632654.....	114	2633413.....	89	2940029.....	155	3356137.....	198	4610510.....	261	4710388.....	225
2632655.....	114	2633414.....	89	2940031.....	156	3356140.....	198	4610550.....	203	4710389.....	225
2632658.....	114	2633524.....	88	2940032.....	156	3356141.....	198	4610551.....	203	4710391.....	225
2632659.....	114	2633525.....	88	2940034.....	155	3356142.....	198	4610552.....	203	4710402.....	253
2632665.....	114	2633526.....	88	2940035.....	156	3356145.....	157	4610553.....	203	4710403.....	253
2632689.....	118	2633528.....	88	2940038.....	156	3356146.....	157	4610554.....	203	4710404.....	253
2632690.....	118	2633529.....	88	2940039.....	156	3356147.....	157	4610555.....	203	4710410.....	235
2632691.....	118	2633530.....	88	2940044.....	156	3356150.....	157	4610556.....	203	4710415.....	253
2632692.....	118	2633533.....	89	2940045.....	156	3356151.....	157	4610558.....	203	4710426.....	253
2632695.....	118	2633534.....	89	2940048.....	156	3356152.....	157	4610559.....	203	4710428.....	253
2632698.....	118	2633537.....	89	2940054.....	157	3356155.....	198	4610561.....	203	4710429.....	253
2632736.....	120	2633538.....	89	2940056.....	242	3356156.....	198	4610562.....	203	4710430.....	253
2632737.....	120	2633541.....	88	2940057.....	242	3356157.....	198	4610564.....	203	4710431.....	253
2632749.....	117	2633577.....	91	2940063.....	243	3356161.....	198	4610565.....	203	4710432.....	253
2632750.....	117	2633578.....	91	2940064.....	243	3356162.....	198	4610566.....	203	4710441.....	262
2632751.....	117	2633585.....	91	2940065.....	156	3356165.....	198	4610567.....	203	4710443.....	262
2632765.....	117	2633593.....	91	2940066.....	156	3356166.....	198	4610568.....	203	4710445.....	237
2632766.....	117	2633596.....	91	2940073.....	155	3356167.....	198	4610569.....	203	4710446.....	237
2632822.....	156	2633598.....	91	2940074.....	155	3356170.....	198	4610570.....	203	4710448.....	155
2632823.....	156	2633603.....	91	2940077.....	157	3356171.....	198	4610571.....	203	4710449.....	237
2632824.....	156	2634010.....	127	2940079.....	156	3356172.....	198	4610572.....	203	4710450.....	237
2632826.....	117	2634011.....	127	2940087.....	157	3356180.....	198	4610573.....	203	4710451.....	237
2632827.....	117	2634012.....	127	2940096.....	155	3356181.....	198	4610574.....	203	4710452.....	237
2632828.....	117	2634013.....	127	2940105.....	155	3356182.....	198	4610575.....	203	4710453.....	155
2632830.....	117	2634015.....	127	2940110.....	168	3356185.....	198	4610675.....	260	4710454.....	237
2632831.....	117	2634016.....	127	2940111.....	168	3356186.....	198	4610690.....	260	4710455.....	262
2632832.....	117	2634017.....	127	2940114.....	168	3356187.....	198	4610691.....	260	4710457.....	237
2632834.....	117	2634018.....	127	2940115.....	168	3356220.....	157	4610701.....	260	4710458.....	237
2632835.....	117	2634019.....	127	2940117.....	169	3645025.....	197	4610717.....	260	4710472.....	236
2632836.....	117	2645506.....	146	2940119.....	169	3645561.....	197	4610718.....	261	4710491.....	225
2632837.....	117	2645519.....	144	2940240.....	156	3645562.....	197	4610719.....	260	4710492.....	225
2632838.....	117	2645542.....	144	2940241.....	156	3645563.....	197	4610828.....	218	4710493.....	225
2632840.....	117	2645559.....	146	2940242.....	156	3645564.....	197	4610830.....	218	4710498.....	225
2632841.....	117	2645560.....	146	2940245.....	156	3645567.....	197	4610835.....	218	4710589.....	157
2632842.....	117	2645561.....	146	2940246.....	156	3645575.....	197	4610868.....	218	4710590.....	253
2632886.....	117	2647616.....	156	2940247.....	156	3645579.....	197	4611863.....	251	4710591.....	157
2632887.....	117	2690340.....	143	2940301.....	156	3645580.....	197	4611910.....	261	4710592.....	157
2632889.....	117	2690341.....	143	2940330.....	168	3645749.....	197	4612030.....	264	4710631.....	235
2632898.....	251	2690342.....	143	2940331.....	168	3721270.....	154	4615191.....	243	4710711.....	237
2632899.....	251	2690343.....	143	2940332.....	168			4615192.....	243	4710712.....	234
2632900.....	251	2690346.....	143	2940333.....	168			4615200.....	253	4710713.....	237
2632901.....	251	2691060.....	168	2940432.....	77			4615202.....	243	4710771.....	236
2632944.....	112	2691061.....	168	2940433.....	77			4615204.....	155	4710811.....	236
2632948.....	120	2691062.....	168	2940434.....	162			4615205.....	155	4710820.....	232
2632949.....	120	2691063.....	168	2940436.....	77			4615220.....	196	4710821.....	232
2632950.....	120	2691064.....	168	2940455.....	155			4615221.....	196	4710822.....	232
2632951.....	120	2691065.....	168	2940460.....	155			4615222.....	196	4710823.....	232
2632952.....	120	2691066.....	168					4615260.....	252	4710824.....	232
2632953.....	120	2691067.....	168					4615295.....	154	4710825.....	232
2632954.....	120	2691068.....	168					4615296.....	253	4710826.....	232
2632955.....	120	2691074.....	162					4615297.....	154	4710827.....	232
2632956.....	120	2691208.....	142					4615298.....	253	4710860.....	229
2632957.....	120	2691209.....	142					4615305.....	252	4710861.....	229
2632958.....	120	2691211.....	142					4615306.....	252	4710862.....	229
2632959.....	120	2691212.....	142					4615307.....	252	4710863.....	229
2632960.....	120	2691213.....	142					4615308.....	252	4710880.....	264
2633102.....	116	2691214.....	168					4615309.....	252	4710894.....	236
2633103.....	116	2691215.....	168					4615312.....	243	4710896.....	236
2633104.....	116	2691216.....	168					4615313.....	243	4710897.....	236
2633106.....	116	2691217.....	168					4615326.....	252	4710914.....	236
2633109.....	116	2691259.....	142					4615332.....	253	4710932.....	232
2633110.....	116	2691260.....	142					4615340.....	154	4710933.....	232
2633123.....	113	2691261.....	142					4615341.....	154	4710934.....	232
2633124.....	113	2691262.....	142					4615342.....	154	4710935.....	232
2633128.....	113	2691263.....	142					4615344.....	253	4710936.....	232
2633130.....	113	2691270.....	168					4615345.....	154	4710937.....	234
2633250.....	117	2691271.....	168					4615346.....	253	4710938.....	232
2633251.....	117	2691275.....	162					4615347.....	252	4710939.....	232
2633252.....	117	2691306.....	144					4615348.....	252	4710970.....	224
2633253.....	117	2691309.....	143					4615349.....	252	4710971.....	224
2633263.....	117	2691310.....	143					4615450.....	196	4710972.....	224
2633264.....	117	2691312.....	144					4615451.....	196	4710973.....	224
2633265.....	117	2691330.....	242					4615452.....	196	4710978.....	236
2633266.....	117	2691331.....	242					4615453.....	252	4710979.....	236
2633269.....	117	2691410.....	168					4615455.....	196	4710980.....	224
2633300.....	112	2691411.....	168					4710001.....	223	4711359.....	236
2633301.....	112	2691415.....	168					4710002.....	223	4711810.....	232
2633302.....	112	2691416.....	168					4710003.....	223	4711811.....	232
2633303.....	112	2691420.....	168					4710004.....	223	4711812.....	232
2633305.....	113	2691490.....	143					4710020.....	262	4711813.....	232
2633306.....	113	2695001.....	147					4710039.....	236	4711814.....	234
2633307.....	113	2695002.....	147					4710088.....	223	4711815.....	232
2633309.....	113	2695003.....</									



6515318.....266  
 6515322.....266  
 6515324.....267  
 6515326.....267  
 6515338.....267  
 6515443.....267  
 6515454.....263  
 6515455.....263

**7**

7224330.....276  
 7224332.....276  
 7224334.....276  
 7224336.....276  
 7224340.....276  
 7224342.....276  
 7224344.....276  
 7224346.....276  
 7224369.....278  
 7224370.....278  
 7224371.....278  
 7224380.....270  
 7224382.....270  
 7224384.....270  
 7224386.....270  
 7224388.....270  
 7224390.....270  
 7224392.....270  
 7224394.....270  
 7224402.....270  
 7224420.....279  
 7224421.....279  
 7224422.....279  
 7224423.....279  
 7224424.....278  
 7224435.....275  
 7224437.....275  
 7224439.....275  
 7224442.....275  
 7224445.....275  
 7224447.....275  
 7224480.....274  
 7224485.....277  
 7224486.....277  
 7224487.....277  
 7224488.....277  
 7224489.....277  
 7224490.....274  
 7224492.....274  
 7224494.....274  
 7224496.....274  
 7226310.....272  
 7226311.....272  
 7226312.....272  
 7226340.....273  
 7226342.....273  
 7226344.....273  
 7226346.....272  
 7226348.....272  
 7226350.....272  
 7226355.....273  
 7226356.....273  
 7226357.....273  
 7226360.....272  
 7226361.....272  
 7226362.....272  
 7228076.....271  
 7228078.....271  
 7228080.....271  
 7228082.....271  
 7228135.....271  
 7228136.....271  
 7228137.....273  
 7228138.....273  
 7228139.....273  
 7228140.....272  
 7228141.....272  
 7228142.....272  
 7228143.....271  
 7321423.....163  
 7321528.....163  
 7321629.....163  
 7505004.....72  
 7505006.....161  
 7505010.....72  
 7505020.....161  
 7505024.....161  
 7505027.....72  
 7505037.....161  
 7505065.....161  
 7505066.....161  
 7506017.....94  
 7506032.....32  
 7506033.....70  
 7506068.....161  
 7506069.....161  
 7506070.....63  
 7506071.....63  
 7506072.....63  
 7506073.....63  
 7506074.....63  
 7506085.....70  
 7506086.....70  
 7506108.....161  
 7506110.....70  
 7506111.....70  
 7506114.....70  
 7506115.....70  
 7506134.....55  
 7506146.....161

7506148.....8  
 7506150.....8  
 7506151.....8  
 7506152.....8  
 7506153.....8  
 7506225.....70  
 7506238.....10  
 7506239.....10  
 7506240.....10  
 7506242.....10  
 7506283.....70  
 7506310.....54  
 7506400.....70  
 7506401.....70  
 7506420.....54  
 7506422.....6  
 7506423.....6  
 7506430.....30  
 7506432.....70  
 7506476.....31  
 7506477.....31  
 7506482.....70  
 7506483.....70  
 7506488.....72  
 7506489.....72  
 7506490.....72  
 7506493.....161  
 7506494.....72  
 7506495.....72  
 7506496.....72  
 7506497.....72  
 7506498.....72  
 7506499.....72  
 7506500.....72  
 7506501.....72  
 7506502.....72  
 7506510.....29  
 7506511.....29  
 7506512.....29  
 7507020.....65  
 7507021.....65  
 7507022.....65  
 7507068.....72  
 7507075.....65  
 7507076.....65  
 7507077.....65  
 7507079.....65  
 7507082.....65  
 7507083.....65  
 7507084.....65  
 7507085.....65  
 7507087.....65  
 7507088.....65  
 7507089.....65  
 7507092.....65  
 7507093.....161  
 7507094.....65  
 7507147.....34  
 7507152.....65  
 7507154.....158  
 7507161.....9  
 7507162.....9  
 7507163.....9  
 7507239.....161  
 7507240.....63  
 7507241.....63  
 7507242.....63  
 7507243.....63  
 7507244.....63  
 7507245.....63  
 7507246.....63  
 7507290.....63  
 7507303.....31  
 7507304.....31  
 7507306.....31  
 7507328.....31  
 7507329.....31  
 7507330.....64  
 7507331.....64  
 7507332.....64  
 7507338.....161  
 7507340.....64  
 7507341.....64  
 7507342.....64  
 7507343.....64  
 7507344.....64  
 7507347.....71  
 7507390.....9  
 7507395.....9  
 7507396.....9  
 7507397.....9  
 7507398.....9  
 7507450.....64  
 7507451.....64  
 7507452.....64  
 7507453.....64  
 7507454.....64  
 7507460.....63  
 7507461.....63  
 7507462.....63  
 7507470.....148  
 7507476.....65  
 7507477.....65  
 7507478.....65  
 7507479.....65  
 7507483.....65  
 7507484.....65  
 7507495.....72  
 7507496.....72  
 7507497.....72  
 7507498.....72  
 7507499.....72

7507510.....63  
 7507511.....63  
 7507512.....63  
 7507513.....63  
 7507514.....63  
 7507515.....63  
 7508008.....55  
 7508009.....55  
 7508010.....55  
 7508011.....55  
 7508027.....55  
 7508100.....55  
 7510012.....32  
 7510013.....32  
 7510028.....32  
 7510031.....32  
 7510032.....32  
 7510033.....32  
 7510034.....32  
 7510035.....32  
 7510036.....32  
 7510037.....32  
 7510040.....32  
 7510043.....32  
 7510059.....32  
 7510065.....32  
 7510074.....56  
 7510312.....11  
 7510313.....80  
 7510314.....82  
 7510346.....57  
 7510347.....57  
 7510355.....30  
 7510356.....30  
 7510357.....30  
 7510358.....30  
 7510380.....32  
 7510381.....32  
 7510403.....82  
 7510410.....59  
 7510411.....59  
 7510413.....57  
 7510415.....11  
 7510416.....11  
 7510417.....11  
 7510418.....11  
 7510420.....11  
 7510421.....11  
 7510422.....11  
 7510423.....11  
 7510424.....11  
 7510437.....56  
 7510440.....11  
 7510445.....10  
 7510446.....5  
 7510447.....5  
 7510500.....34  
 7510501.....34  
 7510504.....34  
 7510535.....34  
 7510536.....34  
 7510537.....34  
 7510550.....54  
 7510605.....35  
 7510606.....35  
 7510607.....35  
 7510610.....35  
 7510614.....34  
 7510615.....34  
 7510617.....34  
 7510620.....55  
 7510621.....55  
 7510669.....10  
 7510670.....10  
 7510671.....10  
 7510672.....10  
 7510673.....59  
 7510701.....32  
 7510702.....32  
 7510750.....35  
 7510751.....35  
 7510752.....35  
 7510800.....34  
 7510801.....34  
 7510804.....34  
 7510806.....32  
 7510813.....31  
 7510814.....31  
 7510825.....8  
 7510826.....59  
 7510829.....32  
 7510830.....32  
 7510831.....32  
 7510865.....59  
 7510866.....9  
 7510867.....9  
 7510868.....9  
 7510892.....58  
 7510900.....57  
 7510901.....57  
 7510902.....57  
 7510910.....7  
 7510911.....7  
 7510912.....7  
 7510913.....7  
 7510914.....59  
 7510920.....6  
 7510926.....6  
 7510929.....6  
 7510932.....6  
 7510938.....6  
 7510941.....6

7510946.....35  
 7510947.....35  
 7510948.....35  
 7510961.....30  
 7510962.....30  
 7511002.....54  
 7511003.....54  
 7511005.....54  
 7511024.....32  
 7511028.....32  
 7511029.....32  
 7511082.....82  
 7511188.....9  
 7511213.....31  
 7511228.....55  
 7511229.....55  
 7511230.....55  
 7511231.....55  
 7511258.....33  
 7511260.....33  
 7511262.....33  
 7511263.....33  
 7511264.....33  
 7511266.....33  
 7511267.....58  
 7511269.....33  
 7511270.....33  
 7511280.....8  
 7511281.....8  
 7511282.....8  
 7511283.....59  
 7511290.....7  
 7511291.....7  
 7511292.....7  
 7511293.....7  
 7511294.....7  
 7511295.....59  
 7511296.....9  
 7511315.....9  
 7511316.....9  
 7511317.....9  
 7511318.....59  
 7511325.....33  
 7511326.....33  
 7511327.....33  
 7511328.....33  
 7511329.....33  
 7511335.....8  
 7511336.....8  
 7511337.....8  
 7511338.....8  
 7511345.....29  
 7511346.....9  
 7511347.....56  
 7511353.....5  
 7511354.....5  
 7511355.....5  
 7511356.....5  
 7511362.....4  
 7511363.....4  
 7511364.....4  
 7511365.....4  
 7511500.....54  
 7511510.....31  
 7511511.....31  
 7511512.....31  
 7511513.....31  
 7512009.....158  
 7512010.....158  
 7512045.....158  
 7512055.....159  
 7512070.....159  
 7512071.....159  
 7512080.....159  
 7512082.....159  
 7512097.....158  
 7512128.....159  
 7512129.....159  
 7512145.....159  
 7512153.....54  
 7512154.....159  
 7512160.....159  
 7513025.....242  
 7514201.....243  
 7514203.....243  
 7515001.....77  
 7515002.....77  
 7515003.....77  
 7515019.....77  
 7515020.....77  
 7515077.....78  
 7515085.....77  
 7515086.....77  
 7515087.....77  
 7515100.....75  
 7515101.....75  
 7515102.....75  
 7515110.....75  
 7515111.....75  
 7515112.....75  
 7515286.....65  
 7515287.....161  
 7515288.....161  
 7515290.....75  
 7515291.....75  
 7515292.....75  
 7515296.....75  
 7515299.....75  
 7515310.....78  
 7515325.....75  
 7515326.....75  
 7515327.....75

7516009.....157  
 7516010.....153  
 7516011.....153  
 7516012.....153  
 7516013.....153  
 7516014.....153  
 7516015.....153  
 7516016.....153  
 7516017.....153  
 7516018.....153  
 7516019.....153  
 7516020.....153  
 7516066.....153  
 7516068.....153  
 7516070.....153  
 7516072.....153  
 7516218.....209  
 7516219.....209  
 7516231.....209  
 7516233.....209  
 7516235.....209  
 7516236.....209  
 7516243.....209  
 7516245.....158  
 7516249.....158  
 7516250.....158  
 7516256.....209  
 7516257.....209  
 7516329.....157  
 7516330.....248  
 7516345.....264  
 7516380.....161  
 7520001.....180  
 7520002.....180  
 7520003.....180  
 7520004.....180  
 7520005.....180  
 7520016.....180  
 7520038.....180  
 7520060.....180  
 7520061.....180  
 7520062.....180  
 7520063.....180  
 7520065.....180  
 7525018.....67  
 7525019.....67  
 7525020.....66  
 7525025.....160  
 7525026.....66  
 7525027.....66  
 7525028.....66  
 7525051.....66  
 7525052.....67  
 7525053.....67  
 7525058.....67  
 7525060.....160  
 7525061.....66  
 7525063.....66  
 7525064.....66  
 7525068.....66  
 7525072.....67  
 7525073.....160  
 7525074.....66  
 7525081.....67  
 7525082.....67  
 7525085.....67  
 7525086.....67  
 7525087.....67  
 7525130.....66  
 7525132.....66  
 7525134.....66  
 7525220.....66  
 7526008.....66  
 7526009.....66  
 7526105.....66  
 7527035.....157  
 7527037.....157  
 7528001.....152  
 7528004.....152  
 7528080.....66  
 7528081.....66  
 7528082.....66  
 7528099.....157  
 7528115.....157  
 7528120.....157  
 7528121.....157  
 7528125.....67  
 7528200.....152  
 7528201.....152  
 7529070.....39  
 7529071.....39  
 7530005.....72  
 7530006.....160  
 7530007.....160  
 7530032.....39  
 7530033.....39  
 7530035.....160  
 7530090.....69  
 7530091.....69  
 7530092.....69  
 7531015.....60  
 7531022.....242  
 7534004.....69  
 7534039.....160  
 7534040.....160  
 7534079.....71  
 7534084.....57  
 7534085.....63  
 7534086.....63  
 7534087.....63  
 7534088.....63  
 7534094.....158

7534106.....69  
 7534107.....38  
 7534161.....62  
 7534162.....62  
 7534163.....62  
 7534200.....39  
 7534201.....39  
 7534204.....39  
 7534205.....39  
 7534206.....69  
 7534208.....39  
 7534283.....37  
 7534286.....37  
 7534287.....37  
 7534288.....37  
 7534289.....37  
 7534290.....37  
 7534293.....37  
 7534320.....71  
 7534330.....73  
 7534337.....73  
 7534340.....74  
 7534341.....74  
 7534342.....74  
 7534343.....74  
 7534382.....38  
 7534383.....38  
 7534384.....38  
 7534386.....38  
 7534387.....38  
 7534388.....76  
 7534389.....38  
 7534400.....36  
 7534401.....36  
 7534402.....36  
 7534404.....36  
 7534406.....36  
 7534420.....69  
 7534430.....36  
 7534433.....36  
 7534437.....38  
 7534438.....38  
 7534457.....36  
 7534462.....69  
 7534480.....36  
 7534481.....36  
 7534482.....36  
 7534491.....54  
 7534500.....62  
 7534501.....62  
 7534502.....160  
 7534510.....67  
 7534511.....67  
 7534512.....67  
 7534519.....67  
 7534522.....67  
 7534524.....67  
 7534532.....160  
 7534590.....67  
 7534594.....67  
 7534598.....67  
 7534612.....39  
 7534613.....39  
 7534614.....39  
 7534615.....39  
 7534621.....39  
 7534622.....39  
 7534623.....67  
 7534635.....36  
 7534636.....36  
 7534641.....37  
 7534643.....37  
 7534644.....37  
 7534645.....37  
 7534646.....37  
 7534663.....38  
 7534664.....55  
 7534665.....38  
 7534670.....37  
 7534671.....37  
 7534672.....37  
 7534851.....60  
 7534852.....60  
 7534853.....60  
 7534854.....60  
 7534855.....60  
 7534856.....60  
 7534860.....62  
 7534861.....62  
 7534862.....62  
 7534863.....62  
 7535130.....158  
 7535186.....158  
 7535238.....158  
 7535240.....158  
 7535244.....158  
 7536009.....18  
 7536010.....18  
 7536011.....18  
 7536014.....59  
 7536015.....56  
 7536041.....18  
 7536042.....18  
 7536105.....58  
 7536125.....18  
 7536127.....18  
 7536247.....19  
 7536248.....57  
 7536249.....19  
 7536250.....19

7536251.....	19	7541448.....	204	7543404.....	15	7550887.....	148	7912015.....	162	7932200.....	169
7536253.....	68	7541450.....	204	7543409.....	15	7550890.....	148	7912017.....	166	7932205.....	91
7536255.....	19	7541452.....	204	7543410.....	15	7550891.....	148	7912018.....	166	7932206.....	169
7536256.....	21	7541456.....	204	7543412.....	15	7550892.....	148	7912019.....	162	7932207.....	91
7536257.....	21	7541457.....	204	7543429.....	15	7550900.....	148	7912030.....	162	7932208.....	94
7536258.....	21	7541458.....	204	7543433.....	15	7550901.....	148	7912032.....	162	7932209.....	94
7536259.....	21	7541460.....	204	7543437.....	15	7551225.....	149	7912034.....	162	7932210.....	94
7536260.....	57	7541462.....	204	7543470.....	14	7551226.....	149	7912045.....	162	7932211.....	94
7536261.....	21	7541465.....	205	7543471.....	14	7551227.....	149	7912047.....	166	7932212.....	94
7536262.....	21	7541466.....	205	7543472.....	14	7551228.....	149	7912048.....	166	7932213.....	94
7536263.....	21	7541469.....	205	7543474.....	14	7551230.....	149	7912050.....	164	7932214.....	94
7536264.....	59	7541470.....	204	7543475.....	14	7551231.....	149	7912052.....	78	7932215.....	94
7536265.....	19	7541472.....	204	7543477.....	14	7551232.....	149	7912053.....	78	7932216.....	94
7536266.....	19	7541473.....	204	7543479.....	14	7551233.....	149	7912055.....	166	7932217.....	94
7536267.....	19	7541479.....	82	7543481.....	14	7551234.....	149	7912060.....	166	7932218.....	94
7536268.....	19	7541552.....	43	7543487.....	14	7551235.....	149	7912099.....	164	7932219.....	94
7536269.....	19	7541553.....	43	7543490.....	17	7551236.....	149	7912102.....	164	7932240.....	98
7536287.....	23	7541554.....	43	7543491.....	17	7551237.....	149	7912103.....	164	7932242.....	98
7536288.....	23	7541555.....	43	7543492.....	17	7551238.....	149	7912104.....	164	7932243.....	169
7536289.....	23	7541573.....	45	7543493.....	17	7551239.....	149	7912106.....	162	7932244.....	98
7536290.....	23	7541574.....	45	7543496.....	17	7551240.....	149	7912107.....	164	7932252.....	99
7536291.....	23	7541579.....	45	7543549.....	17	7551241.....	149	7912165.....	162	7932253.....	169
7536292.....	23	7541580.....	45	7543551.....	17	7551242.....	149	7912166.....	162	7932254.....	99
7536342.....	74	7541581.....	45	7545930.....	150	7551243.....	149	7912167.....	162	7932255.....	97
7536343.....	242	7541583.....	45	7545931.....	150	7551244.....	149	7912168.....	162	7932256.....	97
7536380.....	74	7541587.....	45	7545932.....	150	7551245.....	149	7912169.....	162	7932257.....	97
7536381.....	74	7541588.....	45	7545933.....	150	7551246.....	149	7912170.....	162	7932258.....	97
7536385.....	74	7541589.....	45	7550002.....	149	7551247.....	149	7912171.....	162	7932259.....	97
7536392.....	74	7541592.....	45	7550003.....	149	7551248.....	149	7912175.....	163	7932263.....	100
7536393.....	74	7541593.....	45	7550004.....	149	7551250.....	149	7912176.....	163	7932264.....	100
7536394.....	242	7541595.....	45	7550005.....	149	7551251.....	149	7912177.....	163	7932295.....	95
7536395.....	74	7541615.....	46	7550008.....	149	7551252.....	149	7912178.....	163	7932296.....	95
7536406.....	167	7541616.....	46	7550010.....	149	7551254.....	149	7912179.....	163	7932297.....	95
7536407.....	167	7541618.....	46	7550013.....	149	7551255.....	149	7912180.....	163	7932298.....	95
7536408.....	167	7541619.....	46	7550023.....	151	7551256.....	149	7912181.....	163	7932299.....	95
7536431.....	76	7541630.....	46	7550025.....	149	7551257.....	149	7912182.....	163	7932300.....	95
7536432.....	76	7541631.....	46	7550026.....	149	7551258.....	149	7912183.....	163	7932305.....	103
7536440.....	74	7541632.....	46	7550027.....	149	7551352.....	167	7912184.....	163	7932306.....	103
7536441.....	74	7541859.....	57	7550028.....	149	7551353.....	167	7912185.....	165	7932307.....	103
7536458.....	21	7541942.....	50	7550029.....	149	7551359.....	167	7912186.....	165	7932308.....	103
7536459.....	21	7541948.....	56	7550030.....	149	7551360.....	167	7912187.....	165	7932309.....	103
7536460.....	21	7542032.....	52	7550031.....	149	7551521.....	149	7912190.....	165	7932310.....	103
7536461.....	59	7542036.....	52	7550032.....	149	7551522.....	149	7912191.....	165	7932311.....	103
7536462.....	21	7542037.....	52	7550033.....	149	7551523.....	149	7912192.....	165	7932312.....	103
7536463.....	21	7542038.....	52	7550038.....	151	7551524.....	149	7912195.....	165	7932313.....	103
7536467.....	20	7542050.....	57	7550040.....	151	7551525.....	149	7912196.....	165	7932314.....	103
7536468.....	20	7542055.....	52	7550041.....	151	7551526.....	149	7912198.....	165	7932315.....	102
7536469.....	59	7542056.....	52	7550042.....	151	7551527.....	149	7912199.....	165	7932316.....	102
7536470.....	20	7542072.....	52	7550043.....	151	7551528.....	149	7912200.....	165	7932317.....	102
7536471.....	20	7542073.....	52	7550044.....	151	7551529.....	149	7912201.....	165	7932318.....	102
7536472.....	68	7542074.....	52	7550050.....	151	7551531.....	149	7912202.....	165	7932319.....	102
7536473.....	20	7542075.....	52	7550051.....	151	7551541.....	149	7912205.....	165	7932320.....	102
7536476.....	20	7542120.....	52	7550052.....	151	7551542.....	149	7912206.....	165	7932321.....	102
7536477.....	20	7542121.....	52	7550053.....	148	7551543.....	149	7912207.....	165	7932322.....	102
7536525.....	68	7542122.....	52	7550057.....	148	7551544.....	149	7912208.....	165	7932355.....	92
7536526.....	68	7542168.....	53	7550062.....	149	7551545.....	149	7912215.....	164	7932356.....	92
7536527.....	68	7542169.....	53	7550064.....	149	7551546.....	149	7912216.....	164	7932357.....	92
7536531.....	68	7542170.....	53	7550067.....	149	7551547.....	149	7912217.....	164	7932358.....	92
7536532.....	68	7542171.....	53	7550069.....	149	7551548.....	149	7912220.....	165	7932359.....	92
7536534.....	68	7542172.....	53	7550088.....	149	7551549.....	149	7912225.....	164	7932360.....	92
7536550.....	23	7542173.....	53	7550098.....	149	7551550.....	149	7912226.....	164	7932361.....	169
7536551.....	23	7542184.....	53	7550302.....	148	7552122.....	167	7912227.....	164	7932362.....	92
7536554.....	23	7542185.....	53	7550350.....	150	7552123.....	167	7912230.....	164	7932365.....	93
7536555.....	23	7542187.....	53	7550351.....	150	7552124.....	167	7912231.....	164	7932366.....	93
7536556.....	23	7542189.....	53	7550352.....	150	7552125.....	167	7912232.....	164	7932367.....	93
7536559.....	23	7542201.....	53	7550353.....	150	7552126.....	167	7915050.....	264	7932368.....	93
7536564.....	23	7542202.....	53	7550354.....	150	7553011.....	209	7930082.....	184	7932369.....	93
7536566.....	23	7542203.....	53	7550368.....	148	7553012.....	209	7930083.....	184	7932370.....	93
7541033.....	47	7542204.....	53	7550369.....	148	7553026.....	209	7930084.....	184	7932371.....	93
7541036.....	160	7542205.....	53	7550370.....	150	7553027.....	209	7930100.....	184	7932372.....	93
7541037.....	160	7542209.....	53	7550371.....	150	7911101.....	240	7930101.....	184	7932375.....	97
7541038.....	160	7542220.....	158	7550372.....	150	7911105.....	240	7930103.....	184	7932376.....	97
7541055.....	55	7542240.....	53	7550373.....	150	7911115.....	240	7930104.....	184	7932377.....	97
7541056.....	55	7542241.....	53	7550374.....	150	7911124.....	240	7932070.....	99	7932378.....	97
7541065.....	47	7542242.....	53	7550375.....	150	7911132.....	240	7932071.....	99	7932379.....	97
7541066.....	47	7542258.....	60	7550376.....	150	7911135.....	239	7932072.....	99	7932380.....	97
7541072.....	47	7542270.....	53	7550377.....	150	7911136.....	239	7932073.....	99	7932385.....	96
7541073.....	47	7542271.....	53	7550378.....	150	7911145.....	239	7932075.....	98	7932386.....	96
7541074.....	47	7542284.....	60	7550384.....	148	7911146.....	240	7932076.....	98	7932387.....	96
7541077.....	47	7542285.....	60	7550385.....	148	7911150.....	166	7932077.....	98	7932388.....	96
7541092.....	46	7542286.....	60	7550386.....	148	7911151.....	166	7932078.....	98	7932389.....	96
7541093.....	71	7542296.....	53	7550512.....	151	7911155.....	240	7932079.....	98	7932390.....	96
7541105.....	167	7542297.....	53	7550514.....	151	7911156.....	240	7932084.....	169	7935015.....	12
7541115.....	46	7542298.....	53	7550515.....	151	7911158.....	240	7932115.....	100	7935016.....	12
7541120.....	44	7542344.....	52	7550516.....	151	7911160.....	166	7932116.....	100	7935017.....	12
7541132.....	54	7542345.....	52	7550517.....	151	7911161.....	166	7932117.....	100	7935018.....	59
7541141.....	71	7542346.....	52	7550524.....	167	7911162.....	239	7932120.....	100	7935020.....	12
7541160.....	61	7542347.....	52	7550525.....	151	7911163.....	239	7932121.....	100	7935021.....	12
7541161.....	61	7543055.....	54	7550527.....	151	7911164.....	239	7932122.....	100	7935022.....	12
7541162.....	61	7543076.....	17	7550528.....	151	7911170.....	240	7932160.....	98	7935025.....	13
7541180.....	46	7543077.....	17	7550529.....	151	7911225.....	254	7932161.....	98	7935026.....	13
7541191.....	160	7543078.....	17	7550554.....	151	7911226.....	257	7932166.....	99	7935027.....	13
7541192.....	61	7543080.....	17	7550555.....	151	7911227.....	257	7932175.....	90	7935028.....	59
7541193.....	61	7543081.....	17	7550556.....	151	7911228.....	254	7932176.....	90	7935045.....	12
7541194.....	61	7543171.....	17	7550557.....	151	7911229.....	257	7932177.....	90	7935046.....	12
7541195.....	61	7543172.....	17	7550558.....	151	7911230.....	254	7932178.....	90	7935047.....	12
7541196.....											